



SAN PEDRO BAY PORTS **CLEAN AIR ACTION PLAN**

2018 FEASIBILITY ASSESSMENT for
DRAYAGE TRUCKS

MARCH 2019

UPDATED WITH ADDENDUM MAY 2020

PAGE INTENTIONALLY LEFT BLANK

SAN PEDRO BAY PORTS
CLEAN AIR ACTION PLAN

Important Notes: 2018 Feasibility Assessment for Drayage Trucks

The San Pedro Bay Ports Clean Air Action Plan 2017 Update (CAAP) established the need to prepare feasibility assessments to evaluate the status of technology and supporting infrastructure that will be required to achieve the various CAAP strategies. This 2018 Feasibility Assessment for Drayage Trucks is the first of the series to be released. It is intended to evaluate the current state of zero-emission (ZE) and near-zero-emission (NZE) fuel-technology platforms suitable for drayage trucks – including infrastructure readiness to fuel and service them. The Assessment’s overarching objective is to characterize feasibility for near-term (2018 to 2021), large-scale deployments of drayage trucks using such platforms.

This Assessment is not meant to be a policy document, nor to inventory emission reductions that could be realized through the use of ZE and/or NZE drayage trucks, nor to characterize the associated health benefits. It is not meant to establish timelines for meeting various CAAP goals, or forecast commercialization (especially beyond 2021). It provides a snapshot about which ZE and/or NZE drayage truck platforms are feasible today, or will likely be feasible by 2021 – for widespread deployment across the SPBP complex. Please refer to the Framework for Clean Air Action Plan Feasibility Assessments (2017) document (see report text) for the overall process and intent as laid forth in the CAAP.

This Assessment uses tables to summarize ratings about the relative degree to which various drayage truck fuel-technology platforms are deemed to be “feasible” today. This is done for four key feasibility parameters: Commercial Availability, Operational Feasibility, Infrastructure Availability, and Economic Workability. For each main feasibility parameter and the individual criteria that define it, the tables provide pie ratings in quarter increments, which range from “little/no achievement” of a given feasibility criteria, to “fully achieved” today. The use of pie ratings is not meant to represent precise percentages of achievement for a given feasibility criteria. Rather, these ratings summarize the relative degrees of progress towards full or near-full achievement.

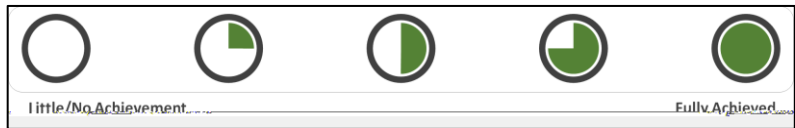

This Assessment does not include end user monetary incentives when calculating feasibility for every parameter. Incentive sums fluctuate, have uncertain long-term availability, and are not necessarily available to all end users. Thus, some costs calculations presented in this Assessment were calculated based on non-incentivized totals.

The Ports intend to prepare updated drayage truck feasibility assessments at least every three years. This will be done more frequently if warranted by new, relevant information. For example, the ports may decide to annually update portions of this Assessment if new ZE and/or NZE technologies become truly commercially available, and/or if there is a breakthrough development with infrastructure. Please

2018 Feasibility Assessment for Drayage Trucks

refer to the Framework for Clean Air Action Plan Feasibility Assessments (2017) document (see text) for the overall process and intent, as laid forth in the CAAP.

This Assessment was developed over many months based on significant outreach, research and stakeholder feedback. A draft assessment was released in December 2018 for public comment period, and the report was revised significantly, as deemed necessary. This 2018 Feasibility Assessment for Drayage Trucks – as well as the public comments that were received – will be reported to the respective Boards of Harbor Commissioners and posted at www.cleanairactionplan.org.

Note: This report was amended with a TRL status update May 2020 as an Addendum.



Port of
LONG BEACH
The Green Port
Port of Long Beach | Environmental Planning
4801 Airport Plaza Drive | Long Beach, CA 90815
562.283.7100



THE PORT
OF LOS ANGELES
Port of Los Angeles | Environmental Management
425 S. Palos Verdes Street | San Pedro, CA 90731
310.732.3675

The San Pedro Bay Ports Clean Air Action Plan was developed with the participation and cooperation of the staff of the US Environmental Protection Agency, California Air Resources Board and the South Coast Air Quality Management District.

Authorship and Uses

This report was prepared by a consulting team consisting of individuals from Tetra Tech and its subcontractor, Gladstein, Neandross & Associates (GNA). Reference herein to any specific commercial product, process, or service by trade name, trademark, manufacturer, or otherwise, does not necessarily constitute or imply endorsement, recommendation, and/or favoring by the Ports or the report authors.

Acknowledgements

Front and back cover photos: Provided by the Port of Long Beach

The following Tetra Tech team members prepared and/or edited this report:

- Patrick Couch, (Gladstein, Neandross & Associates)
- Jonathan (Jon) Leonard, (Gladstein, Neandross & Associates)
- Eleanor Johnstone, (Gladstein, Neandross & Associates)
- Rodger Lueras, (Gladstein, Neandross & Associates)
- Eddy Huang, Ph.D. (Tetra Tech)
- Charng-Ching Lin, Ph.D. (Tetra Tech)

Individuals from many organizations provided important inputs for this report, and/or generally assisted to gather information. These organizations included, but were not limited to, the Port of Long Beach, the Port of Los Angeles, the California Air Resources Board, the California Energy Commission, the South Coast Air Quality Management District, and the North American Council for Freight Efficiency.

In addition to staff from the Port of Long Beach and the Port of Los Angeles, the following individuals served as peer reviewers for this report. In this role, they provided edits/comments/augmentations that the authors incorporated into the report.

| Names of Peer Reviewers | Organization / Affiliation |
|--------------------------------|--------------------------------------|
| Lauren Dunlap and Ray Gorski | Starcrest Consulting Group, LLC |
| Kenneth Kelly | National Renewable Energy Laboratory |

The authors gratefully acknowledge all the valued inputs from the contributing individuals and peer reviewers.

List of Terms

| ACRONYM | DEFINITION |
|----------------------------|---|
| AQMP | Air Quality Management Plan |
| ARB | California Air Resources Board (Also "CARB") |
| AB | Assembly Bill |
| BAT | Broadly Applicable Truck |
| BATS | Broadly Applicable Truck Specification |
| BEV | Battery Electric Vehicle |
| BE | Battery Electric |
| CBEV | Commercial Battery Electric Vehicle |
| CO₂ | Carbon Dioxide |
| CI | Carbon Intensity |
| CAA | Clean Air Act (Federal) |
| CEC | California Energy Commission |
| CNG | Compressed Natural Gas |
| CWI | Cummins Westport Inc. |
| DPM | Diesel Particulate Matter |
| DTNA | Daimler Trucks of North America |
| EGR | Exhaust Gas Recirculation |
| EPA | U.S. Environmental Protection Agency |
| FC | Fuel Cell |
| g/bhp-hr | Grams per Brake Horsepower-Hour |
| gCO_{2e}/MJ | Grams of carbon dioxide equivalent per mega Joule |
| g/mi | Grams per mile |
| GHGs | Greenhouse Gases |
| HDE | Heavy-Duty Engine |
| HDV | Heavy-Duty Vehicle |
| HHDV | Heavy-Heavy-Duty Vehicle |
| HHDT | Heavy-Heavy-Duty Truck |
| ICCT | International Council for Clean Transportation |
| ICE | Internal Combustion Engine |

2018 Feasibility Assessment for Drayage Trucks

| ACRONYM | DEFINITION |
|-----------------------|---|
| LNG | Liquefied Natural Gas |
| NAAQS | National Ambient Air Quality Standards |
| NG | Natural Gas |
| NO_x | Oxides of Nitrogen |
| OEM | Original Equipment Manufacturer |
| OLNS | Optional Low NO _x Standard |
| NZE | Near-Zero-Emission |
| PDTR | Port Drayage Truck Registry |
| PM | Particulate Matter |
| PEMFC | Proton Exchange Membrane Fuel Cell |
| RNG | Renewable Natural Gas |
| ROI | Return on Investment |
| SCAQMD | South Coast Air Quality Management District |
| SCAB | South Coast Air Basin |
| SCR | Selective Catalytic Reduction |
| TCO | Total Cost of Ownership |
| TTSI | Total Transportation Services, Inc. |
| ZE | Zero-Emission |

Table of Contents

Table of Contents viii

Executive Summary 1

1. Introduction 10

 1.1. Background: Clean Air Action Plan and Clean Trucks Program 10

 1.2. Origin and Framework for CAAP Feasibility Assessments 10

2. Overview of 2018 Feasibility Assessment for Drayage Trucks 11

 2.1. Overall Methodology and Anticipated Outcomes 11

 2.2. Timeline, Applicability, Scope and Limitations 11

 2.3. Selection of Credible Information Sources 13

3. Overview of the Existing San Pedro Bay Ports Drayage Fleet 14

 3.1. Late-2018 Snapshot by Key Fuel-Technology Types 14

 3.2. Drayage Fleet Size 16

 3.3. Drayage Operational Requirements 17

4. Applied Parameters and Initial Screening of Leading Fuel-Technology Platforms 18

5. Assessment of Commercial Availability 20

 5.1. Background: Criteria and Methodology 20

 5.2. Production with Major OEM Involvement 20

 5.2.1. Surveys Sent to Heavy-Duty Truck OEMs 20

 5.2.2. OEM Public Announcements, Statements and Literature 22

 5.3. Proven Network and Capability for Sales, Service, Parts and Warranty 24

 5.4. Sufficient Means and Timeline for Production 25

 5.5. Existence of Current and/or Near-Term Equipment Orders 25

 5.6. Advancing Commercial Availability: Essential Role of Truck Demonstrations 27

 5.6.1. Natural Gas Drayage Truck Demonstrations 28

 5.6.2. Battery-Electric and Fuel Cell Drayage Truck Demonstrations 29

 5.6.3. Larger-Scale Next-Generation Demonstrations 32

 5.7. OEM Expectations for Commercial Availability by 2021 32

 5.8. Summary of Findings for Commercial Availability 34

 5.8.1. Status in 2018 for Leading Fuel-Technology Platforms 34

 5.8.2. Discussion and Implications to Overall Feasibility 35

6. Assessment of Technical Viability 38

 6.1. Background: Criteria and Methodology 38

2018 Feasibility Assessment for Drayage Trucks

- 6.2. Estimated 2018 TRL Ratings (with Prognosis for 2021) 39
- 6.3. Comparison to CARB’s Most-Recent Technology Snapshot and TRL Ratings 41
- 6.4. Additional References for Assessing Technical Viability 43
- 6.5. Summary of Findings for Technical Viability 48
- 6.6. Implications to Remainder of 2018 Feasibility Assessment for Drayage Trucks 51
- 7. Assessment of Operational Feasibility 52
 - 7.1. Background: Criteria and Methodology 52
 - 7.2. Drayage Company Survey: Scope and Results 53
 - 7.3. Comparison of Survey Findings to Other Studies 56
 - 7.3.1. Discussion of Specific References and Relevant Findings 57
 - 7.4. Broadly Applicable Truck (BAT) Concept 57
 - 7.5. Application of Operational Feasibility Criteria 59
 - 7.5.1. Basic Performance 59
 - 7.5.2. Range (Including Degradation) 60
 - 7.5.3. Speed and Frequency of Fueling/Charging 63
 - 7.5.4. Driver Comfort, Safety, and Fueling Procedures 65
 - 7.5.1. Truck Weight Impacts 66
 - 7.5.2. Availability of Replacement Parts and Support for Maintenance / Training 68
 - 7.6. Summary of Findings for Operational Feasibility 69
- 8. Assessment of Infrastructure Availability 72
 - 8.1. Criteria and Methodology 72
 - 8.2. Important Considerations Associated with the Baseline Diesel Infrastructure and Fleet 72
 - 8.2.1. Number of Stations and Convenience of Location 72
 - 8.2.2. Infrastructure Implications of Common Truck Parking Procedures 73
 - 8.3. Application of Criteria to Natural Gas Fueling Infrastructure 73
 - 8.3.1. Station Location and Footprint 74
 - 8.3.2. Infrastructure Buildout 74
 - 8.3.3. Codes and Standards 75
 - 8.4. Application of Criteria to Battery-Electric Charging Infrastructure 76
 - 8.4.1. Station Location and Footprint 76
 - 8.4.2. Infrastructure Buildout 77
 - 8.4.3. Codes and Standards 78
 - 8.5. Additional References for Assessing Infrastructure Availability 80

2018 Feasibility Assessment for Drayage Trucks

| | | |
|--------|---|-----|
| 8.6. | Summary of Findings for Infrastructure Availability | 82 |
| 9. | Assessment of Economic Workability | 84 |
| 9.1. | Criteria and Methodology | 84 |
| 9.2. | Incremental Vehicle Capital Costs | 85 |
| 9.2.1. | Financing Costs | 87 |
| 9.3. | Fuel, Operational, and Maintenance Costs | 87 |
| 9.3.1. | Fuel Economy | 87 |
| 9.3.2. | Fuel Price | 87 |
| 9.3.3. | Maintenance Costs | 89 |
| 9.3.4. | Insurance, Registration, and Depreciation Costs | 90 |
| 9.4. | Infrastructure Capital and Operational Costs | 91 |
| 9.5. | Incentives | 92 |
| 9.6. | Total Cost of Ownership Results | 92 |
| 9.7. | Impacts on Cargo Capacity | 95 |
| 9.8. | Cost Effectiveness, Workforce, and Cargo Diversion Considerations | 96 |
| 9.9. | Summary of Findings for Economic Issues and Considerations | 99 |
| 10. | Findings and Conclusions for 2018 Feasibility Assessment for Drayage Trucks | 102 |
| 10.1. | Summary of the Assessment’s Scope, Methodology and Breadth of Application | 102 |
| 10.2. | Summary of Findings: Commercial Availability | 103 |
| 10.3. | Summary of Findings: Technical Viability | 104 |
| 10.4. | Summary of Findings: Operational Feasibility | 105 |
| 10.5. | Summary of Findings: Infrastructure Availability | 106 |
| 10.6. | Summary of Findings: Economic Workability | 107 |
| 10.7. | Conclusion: 2018 Feasibility per All Five Key Parameters | 108 |
| | ZE Battery-Electric Trucks | 109 |
| | NZE Natural Gas Trucks | 109 |
| 10.8. | Looking Forward: ZE Commercial and Technological Outlook for Post-2021 | 110 |
| 11. | Appendix A: Criteria for Acceptable Data Sources | 112 |
| 12. | Appendix B: Summary of Relevant Incentive Programs | 113 |
| 12.1. | HVIP Program | 113 |
| 12.2. | Low Carbon Fuel Standard | 113 |
| 12.3. | VW Mitigation Trust Funds | 114 |
| 12.4. | Southern California Edison’s Charge Ready Transport Program | 114 |

2018 Feasibility Assessment for Drayage Trucks

13. Appendix C: Truck Operator Survey Questions and Summary of Responses 115
1 . Addendum A: Technology Readiness Level Status Update for NZE NG Engines.....121

2018 Feasibility Assessment for Drayage Trucks

LIST OF TABLES

| | |
|---|-----|
| Table 1. General types of unacceptable information / data sources for 2018 Feasibility Assessment | 14 |
| Table 2. Operational assumptions for a "Broadly Applicable Truck" (BAT) | 17 |
| Table 3. Criteria and base considerations used to evaluate Commercial Availability | 20 |
| Table 4. Class 8 OEMs / suppliers receiving survey on ZE/NZE products, opportunities and challenges..... | 21 |
| Table 5: Summary of responses from surveyed Class 8 OEMs about current (2018) commercial offerings..... | 21 |
| Table 6. Snapshot of commercial offerings by OEMs for ZE or NZE Class 8 Trucks, by platform type | 22 |
| Table 7: OEM involvement in pre-commercial demonstrations of ZE Class 8 trucks in drayage | 30 |
| Table 8: Summary of responses from surveyed Class 8 OEMs about expected 2021 commercial Class 8 trucks..... | 32 |
| Table 9. Summary of ratings by key criteria: 2018 Commercial Availability | 35 |
| Table 10: Definitions for Technology Readiness Levels (TRLs) adapted from U.S. DOE | 39 |
| Table 11. "Hot button" vehicle-specific issues identified by NACFE for Class 8 battery-electric trucks..... | 43 |
| Table 12. NACFE's comparison of Class 7 and 8 battery-electric trucks to diesel baseline trucks | 45 |
| Table 13: Summary: 2018 Technical Viability using TRL values (with 2021 prognoses) | 49 |
| Table 14: Criteria for establishing Operational Feasibility for emerging drayage truck platforms. | 53 |
| Table 15 . Comparison of drayage truck operational parameters from identified studies | 56 |
| Table 16: Operational assumptions for a Broadly Applicable Truck (BAT) | 60 |
| Table 17: Comparison of basic performance capabilities..... | 60 |
| Table 18: Comparison of vehicle range capabilities | 62 |
| Table 19: Estimated fueling/charging rates required for single-shift and two-shift trucks..... | 64 |
| Table 20. Estimated truck curb weights | 67 |
| Table 21. Summary of ratings by key criteria: 2018 Operational Feasibility | 70 |
| Table 22: Criteria for establishing Infrastructure Availability for emerging drayage truck platforms..... | 72 |
| Table 23. CNG Fueling Infrastructure- Required Throughput Estimates | 74 |
| Table 24. EV Charging Infrastructure- Required Throughput Estimates | 77 |
| Table 25. Size of SCE and LADWP Utilities | 78 |
| Table 26: "Hot button" infrastructure-specific issues identified by NACFE for battery-electric trucks | 80 |
| Table 27. Summary of ratings by key criteria: 2018 Infrastructure Availability | 82 |
| Table 28: Criteria for Assessing Economic Workability for Emerging Drayage Truck Platforms | 84 |
| Table 29. Average operating assumptions | 84 |
| Table 30. Baseline Diesel Purchase Prices | 85 |
| Table 31. Vehicle Purchase Price Assumptions | 86 |
| Table 32. Fuel economy, fuel price, and other O&M cost assumptions..... | 87 |
| Table 33. EV Charging Cost Analysis Results..... | 89 |
| Table 34. Vehicle License Fee and Insurance Cost Assumptions | 91 |
| Table 35. Summary of key assumptions for cost of ownership analysis | 93 |
| Table 36. Diesel emissions factors for cost effectiveness analysis | 96 |
| Table 37. Emissions reduction factors and carbon intensity assumptions | 96 |
| Table 38. Summary of ratings by key criteria: 2018 Economic Workability | 100 |
| Table 39. Summary of findings for 2018 Commercial Availability | 103 |
| Table 40: Summary of findings for 2018 Technical Viability and 2021 prognoses | 104 |
| Table 41. Summary of findings for 2018 Operational Feasibility..... | 105 |
| Table 42. Summary of findings for 2018 Infrastructure Availability | 106 |
| Table 43. Summary of findings for 2018 Economic Workability..... | 107 |
| Table 44. Summary of 2018 overall feasibility (all five key parameters) | 108 |

2018 Feasibility Assessment for Drayage Trucks

LIST OF FIGURES

Figure 1. San Pedro Bay Ports drayage truck fleet constitution by engine model year14

Figure 2. Running percentages of diesel and natural gas trucks in the drayage fleet, 2009 to 2018.....15

Figure 3. Active drayage trucks serving the San Pedro Bay Ports, 201716

Figure 4. General screening procedure for applying feasibility parameters to assess fuel-technology platforms18

Figure 5. Type and timeline of ZE and NZE drayage truck demonstrations focused on the San Pedro Bay Ports.28

Figure 6. Summary of CARB’s draft TRL ratings (NASA scale) for ZE and NZE HDV platforms.....42

Figure 7. Distribution of survey responses for "maximum shift distance"54

Figure 8: Survey response distributions for key operational parameters55

Figure 9: Estimated engine power required to sustain at a 6% grade.....59

Figure 10. Incremental truck weight impacts on cargo capacity67

Figure 11. Examples of truck parking at motor carriers73

Figure 12: Battery pack price projections.86

Figure 13. Total 12-year costs of ownership for “Average Truck” scenario (NPV at 7% discount rate)94

Figure 14. Total 12-year costs of ownership for the “Single Shift Truck” scenario (NPV at 7% discount rate)95

Figure 15. Cost effectiveness of criteria pollutant reductions (\$/weighted ton)97

Figure 16. Cost effectiveness of GHG reductions (\$/MT)97

Executive Summary

As required under the San Pedro Bay Ports 2017 Clean Air Action Plan (CAAP) Update, this report provides a 2018 Feasibility Assessment for Drayage Trucks, characterizing the overall feasibility of zero-emission (ZE) and near-zero emission (NZE)¹ Class 8 trucks of various leading fuel-technology platforms to perform drayage service at the San Pedro Bay Ports. The timeline of this Assessment is 2018 to 2021.

For purposes of this Assessment, *feasibility* refers to the ability of alternative fuel/technology drayage trucks to provide similar or better overall performance and achievement compared to today's baseline diesel drayage trucks, when broadly used for all types of drayage service. The following five key parameters were applied to qualitatively and collectively assess overall feasibility.

- Commercial Availability
- Technical Viability
- Operational Feasibility
- Availability of infrastructure and Fuel
- Economic Workability (Key Economic Considerations and Issues)

Five core ZE or NZE fuel-technology platforms were initially screened for this Assessment:

1. ZE Battery electric or direct-grid electric
2. ZE Hydrogen fuel cell electric
3. NZE Advanced diesel internal combustion engine (ICE)
4. NZE Advanced natural gas (or propane) ICE
5. NZE Hybrid-electric (electric drive hybridized with an ICE using any fuel; may incorporate grid electricity)

Two feasibility parameters – Commercial Availability and Technical Viability – were used to initially screen these five core ZE and NZE fuel-technology platforms. Any fuel-technology platform that today meets basic considerations for these two parameters (or appears very likely to do so by 2021) was then further assessed by applying the three remaining feasibility parameters (Operational Feasibility, Infrastructure Availability and Economic Workability).

Results and findings of this 2018 Feasibility Assessment for Drayage Trucks are summarized below. Importantly, this Assessment represents a snapshot in time and is not intended to preclude or discourage expanded development, demonstration and deployment of ZE and NZE fuel-technology platforms that have not yet reached sufficient technological and commercial maturity to be deemed feasible.

Summary of Findings for Commercial Availability

As of late-2018, one ZE and one NZE fuel-technology platform are sold by OEMs in commercially available Class 8 trucks suitable for drayage. Specific findings are as follows:

¹As noted in the 2017 Clean Air Action Plan Update, the Ports have proposed to implement rates and registration requirements following the promulgation of a near-zero emission (NZE) standard by the California Air Resources Board (CARB). CARB is expected to establish the allowable emission level for NZE truck engines in 2019. CARB will also be responsible for certifying whether or not particular truck engines developed by various manufacturers meet this emission level. The Ports will rely on these certifications as the determination of whether or not particular fuel-technology platforms are considered to emit at NZE levels.

2018 Feasibility Assessment for Drayage Trucks –
Executive Summary

- **ZE** battery-electric technology is commercially offered in one Class 8 truck model by a single company, start-up OEM BYD. This is effectively an “early commercial” launch.
- **NZE** natural gas ICE technology is the dominant commercially available Class 8 truck platform that utilizes either a ZE or an NZE system. All six major OEMs are offering Class 8 NZE trucks powered by the 12-liter Cummins Westport ISX12N natural gas engine.
- The other three core fuel-technology platforms that were evaluated – **ZE** fuel cell, **NZE** hybrid electric, and **NZE** diesel ICE platforms – did not meet the basic criteria and considerations to be deemed commercially available in late 2018, nor do they appear (at this time) to be on that path by 2021.

The table below lists Commercial Availability findings for each of the five core fuel-technology platforms, in terms of relative achievement of key criteria and base considerations.

Summary of findings for 2018 Commercial Availability

| Commercialization Criteria | Base Considerations | Assessment of Criteria Achievement in 2018 by Leading ZE and NZE Fuel-Technology Drayage Truck Platforms | | | | |
|--|---|--|--------------|---------------------|------------|----------------|
| | | ZE Battery-Electric | ZE Fuel Cell | NZE Hybrid Electric | NZE NG ICE | NZE Diesel ICE |
| Production and Sales with Major OEM Involvement | Production and full certification by either a major Class 8 truck OEM, or by a proven technology provider that has partnered with the major OEM. | | | | | |
| Proven Network / Capabilities for Sales, Support and Warranty | Demonstrated existing (or near-term planned) network of sufficient dealerships to sell, service, warranty and provide parts for all commercially deployed drayage trucks. | | | | | |
| Sufficient Means and Timeline for Production | Demonstrated capability to manufacture sufficient numbers of Class 8 trucks (suitable for drayage) within timeline to meet existing or expected demand. | | | | | |
| Existence of Current and/or Near-Term Equipment Orders | Demonstrated backlog of orders, or credible expression of interest from prospective customers to submit near-term orders. | | | | | |
| Legend: Commercial Availability (2018) | | | | | | |
| Source of Ratings: based on OEM survey responses, OEM product information, various government sources, and consultant’s industry knowledge. | | | | | | |

In summary, OEMs have significantly accelerated their efforts to develop and commercialize ZE and NZE Class 8 trucks suitable for drayage. As described in detail, early commercial and pre-commercial demonstrations are now underway that are expected to play a critical role to expedite sustainable commercialization and wide deployment of ZE and NZE drayage trucks.

Summary of Findings for Technical Viability

Along with Commercial Availability, Technical Viability is the second parameter used to screen the five core fuel-technology platforms for overall feasibility. To gauge this, Technology Readiness Level (TRL) ratings were assigned

2018 Feasibility Assessment for Drayage Trucks –
Executive Summary

to the five core ZE and NZE platforms (late-2018 status). The table below summarizes assigned TRL ratings for 2018, as well as “educated prognoses” for how those TRL ratings will upwardly evolve by (or before) 2021.

Summary of findings for 2018 Technical Viability

| TRL | Relative Stage of Development | Late-2018 TRLs for Leading Fuel-Technology Platforms (Drayage) | ~2021: Educated Prognoses (by or before) | Comments / Basis for 2021 Educated Prognosis |
|-------|-------------------------------|--|--|---|
| TRL 9 | Systems Operations | | NZE NG ICE (TRL 9) | NZE NG ICE: to reach TRL 9 in Class 8 port drayage, new NZE 12-liter engine <u>needs operational time</u> |
| TRL 8 | Systems Conditioning | NZE NG ICE (TRL 8) | ZE Battery (TRL 8) | ZE Battery Electric: strong progress in transit bus / MDV sectors is likely to advance Class 8 drayage use; ongoing range challenge may <u>limit</u> to short-haul applications |
| TRL 7 | | ZE Battery (TRL 6 to 7) | ZE Fuel Cell or NZE Plug-in Hybrid (TRL 7??) | ZE Fuel Cell: biggest remaining hurdles relate to total cost of ownership, including access to / on-board storage of hydrogen fuel; NZE Plug-in Hybrid: prognosis is a wild card; OEM interest is hard to gauge, but plug-in architecture enables valued "zero-emission mile" capability |
| TRL 6 | Technology Demonstration | ZE Fuel Cell or NZE Plug-in Hybrid (TRL 5 to 6) | NZE Diesel ICE (TRL 5, or higher?) | NZE Diesel ICE: <u>could</u> "leapfrog" to TRL 8 or 9, but <u>only</u> if suitable diesel engine(s) get certified to 0.02 g/bhp-hr NOx (or other CARB OLNS) |
| TRL 5 | Technology Development | NZE Diesel ICE (TRL 5) | | |
| TRL 4 | | | | |

Source: TRL methodology adapted from U.S. DOE, “Technology Readiness Assessment Guide, Table 1: Technology Readiness Levels, September 2011 (see footnote). TRL ratings estimated based on input from 1) OEM surveys, 2) various technical reports, 3) demonstration activities, and 4) meetings with agency technical personnel (CARB, CEC, SCAQMD).

TRL 8 is the stage at which a given platform becomes near-final or final, and has adequately exhibited technical viability through test and demonstration. **TRL 9** constitutes the highest rating; this is the stage at which full technical viability has been achieved and definitively documented.

Key findings are summarized as follows:

- Class 8 **ZE** battery-electric drayage trucks are currently at **TRL 6 to 7** (demonstration and initial systems conditioning). The educated prognosis is they will achieve **TRL 8** by or before 2021.
- Class 8 **NZE** natural gas trucks are rated at **TRL 8** today. The educated prognosis is they will achieve **TRL 9** by or before 2021.
- No other ZE or NZE fuel-technology platform – including advanced diesel ICE technology, which has yet to demonstrate NZE status – currently achieves a TRL rating above the **5-to-6** range.

2018 Feasibility Assessment for Drayage Trucks –
Executive Summary

Per this Assessment’s methodology, only the fuel-technology platforms shown to achieve both screening parameters (Commercial Availability and Technical Viability) were further characterized for their overall feasibility. Thus, the three remaining parameters (Operational Feasibility, Infrastructure Availability, and Economic Workability) were applied to evaluate overall feasibility of the ZE battery-electric and NZE natural gas ICE platforms, using detailed criteria for each parameter.

Summary of Findings for Operational Feasibility

Operational feasibility analyses were performed on the two Class 8 platforms that were determined to be commercially available and technically viable (as of late-2018): ZE battery-electric and NZE natural gas ICE.

Key findings on this important parameter are summarized as follows:

- ZE battery-electric trucks outperform diesel trucks in terms of power, torque, and gradeability, but are currently only applicable to a subset of drayage operations due to limitations on vehicle range, weight, and recharging times. Questions remain as to the adequacy of the service supply chain.
- NZE natural gas trucks are the closest direct replacement for diesel trucks in terms of operational feasibility. Basic performance metrics, range, fueling frequency and speed, driver comfort and safety, and maintenance support are generally comparable to diesel trucks. Maintenance support is expected to be scalable with increased deployments of natural gas trucks through the use of existing truck and engine dealerships.

The table below lists Operational Feasibility findings for these two leading fuel-technology platforms, in terms of relative achievement of key criteria and base considerations.

2018 Feasibility Assessment for Drayage Trucks –
Executive Summary

Summary of findings for 2018 Operational Feasibility

| Operational Feasibility Criteria / Parameter | Base Considerations for Drayage Platforms to Achieve Operational Feasibility | Achievement of Criteria in 2018 for Commercially Available Drayage Truck Platforms | |
|---|--|--|------------|
| | | ZE Battery-Electric | NZE NG ICE |
| Basic Performance | Demonstrated capability to meet drayage company needs for basic performance parameters including power, torque, gradeability, operation of accessories, etc. | | |
| Range | Demonstrated capability to achieve per-shift and daily range requirements found in San Pedro Bay drayage. | | |
| Speed and Frequency of Refueling / Recharging | Demonstrated capability to meet drayage company needs for speed and frequency to refuel / recharge such that revenue operation is not significantly reduced relative to diesel baseline. | | |
| Driver Comfort, Safety, and Refueling Logistics | Proven ability to satisfy typical drayage trucking company's needs for comfort, safety and refueling procedures. | | |
| Availability of Replacement Parts and Support for Maintenance / Training | Verifiable existence of and timely access (equivalent to baseline diesel) to all replacement parts needed to conduct scheduled and unscheduled maintenance procedures. | | |
| | Verifiable existence of maintenance procedure guidelines and manuals, including OEM-provided training courses upon purchase and deployment of new trucks. | | |
| Legend: Operational Feasibility (2018) | | | |
| | | | |
| Source: Based on Drayage Truck Operator Survey responses, footnoted studies, OEM product information, and consultant's industry knowledge. | | | |

Summary of Findings for Infrastructure Availability

With the development ZE and NZE platforms progressing quickly, infrastructure has emerged as one of the most significant near-term barriers to wide-scale adoption of these technologies. Results of the Infrastructure Availability analysis are summarized below for the two ZE or NZE fuel-technology platforms determined to be commercially available and technically viable for Class 8 truck platforms suitable for drayage.

- **ZE** battery-electric truck charging infrastructure is a rapidly changing landscape. Substantial progress has been made toward standardization, but competing standards remain and no clear winner has emerged. It appears highly unlikely, if not impossible, to develop the full charging infrastructure needed by 2021, even if public access charging strategies and clarity on charging standards were resolved and no longer barriers to deployment.

2018 Feasibility Assessment for Drayage Trucks –
Executive Summary

- **NZE** natural gas trucks rely on well-known and proven fueling infrastructure currently in use in many heavy-duty vehicle applications. Still, the ability to build the required infrastructure at the pace needed to fully support the drayage fleet by 2021 remains in doubt.

The table below lists Infrastructure Availability findings for the two remaining fuel-technology platforms, in terms of relative achievement of key criteria and base considerations.

Summary of findings for 2018 Infrastructure Availability

| Infrastructure Criteria / Parameter | Base Considerations for Assessing Infrastructure Availability | Achievement of Criteria for Remaining Drayage Truck Platforms | |
|---|--|---|------------|
| | | ZE Battery-Electric | NZE NG ICE |
| Dwell Time at Station | Refueling/recharging can be accommodated within typical work breaks, lunches, other downtime compatible with trucking company schedules and operational needs. | | |
| Station Location and Footprint | Fleets have existing onsite access to fueling infrastructure, or can be fueled/charged conveniently and affordably off site, at public or private stations. New infrastructure can be installed without extensive redesign, reconfiguration or operational disruptions and there is sufficient electrical or natural gas capacity at the site. | | |
| Infrastructure Buildout | Infrastructure can be constructed at a pace consistent with fleet adoption and able to meet fleet fueling/charging requirements by the end of the assessment period. | | |
| Existence of / Compatibility with Standards | A sufficient body of codes and standards exist from appropriate organizations that enables safe and effective refueling/recharging. The refueling/recharging station technology has already been installed at other trucking companies in the U.S., with sufficient time to assess performance and safety. | | |
| <p>Legend: Infrastructure Availability (2018)</p> | | | |
| <p>Source: based on preliminary OEM survey responses, OEM product information, various government sources, and Tetra Tech team’s industry knowledge.</p> | | | |

Summary of Findings for Economic Workability

The drayage truck sector is generally a low-margin, low-asset base sector. Fuel-technology platforms are needed that can provide a cost of ownership similar to, or better than, baseline diesel ICE trucks. Results of the economic workability analysis are summarized below for the two ZE or NZE fuel-technology platforms determined to be commercially available and technically viable Class 8 truck platforms suitable for drayage.

- **ZE** battery-electric trucks have substantially higher upfront capital costs and require significant investments in infrastructure (see Infrastructure Availability). Fuel and maintenance savings can reduce the impact of the

2018 Feasibility Assessment for Drayage Trucks –
Executive Summary

higher capital cost, but these savings do not make the total cost of ownership comparable to diesel trucks on a net present value basis.

- **NZE** natural gas trucks have higher upfront capital costs but an overall cost of ownership comparable to diesel trucks.

The table below lists Economic Workability findings for the two remaining fuel-technology platforms, in terms of relative achievement of key criteria and base considerations.

Summary of findings for 2018 Economic Workability

| Economic-Related Criteria / Issue | Base Considerations for Assessing General Economic Workability | Achievement of Criteria in 2018 (Commercially Available Truck Platforms) | |
|--|--|--|------------|
| | | ZE Battery-Electric | NZE NG ICE |
| Incremental Vehicle Cost | The upfront capital cost for the new technology is affordable to end users, compared to the diesel baseline. | | |
| Fuel and Other Operational Costs | The cost of fuel / energy for the new technology is affordable, on an energy-equivalent basis (taking into account vehicle efficiency). Demand charges / TOU charges (if any) are understood and affordable. Net operational costs help provide an overall attractive cost of ownership. | | |
| Infrastructure Capital and Operational Costs | Infrastructure-related capital and operational costs (if any) are affordable for end users. | | |
| Potential Economic or Workforce Impacts to Make Transition | There are no known major negative economic and/or workforce impacts that could potentially result from transitioning to the new equipment. | | |
| Existence and Sustainability of Financing to Improve Cost of Ownership | Financing mechanisms, including incentives, are in place to help end users with incremental vehicle costs and/or new infrastructure-related costs, and are likely remain available over the next several years. | | |
| Legend: Economic Workability (2018) | | | |
| Source: based on preliminary OEM survey responses, OEM product information, various government sources, and Tetra Tech team’s industry knowledge. | | | |









Conclusions: 2018 Feasibility across All Five Key Parameters

The table below summarizes the relative degree to which both leading fuel-technology platforms achieve the five key feasibility parameters today; this is specific to drayage service at the San Pedro Bay Ports.

It is important to note these ratings for overall achievement of each five feasibility parameter (in the table below) are based on the analysis of several criteria within that parameter. Because each criterion is important for the success of a given fuel-technology platform in drayage, the overall achievement ratings are based on the lowest criterion score for each feasibility parameter.

2018 Feasibility Assessment for Drayage Trucks –
Executive Summary

Summary of 2018 overall feasibility (all five key parameters)

| Feasibility Parameter / Criteria | Overall Achievement* of Criteria in 2018 (Commercially Available / Technically Viable Truck Platforms) | |
|--|---|---|
| | ZE Battery-Electric | NZE NG ICE |
| Commercial Availability |  |  |
| Technical Viability | TRL 6 to 7 (moving to 7 or 8) | TRL 8 (moving to 9) |
| Operational Feasibility |  |  |
| Infrastructure Availability |  |  |
| Economic Workability |  |  |
| Legend: Achievement of Each Noted Parameter / Criteria (2018)  | | |
| <p>*These ratings for overall achievement of each five feasibility parameter are based on the analysis of several criteria within that parameter. Because each criterion is important for the success of a given fuel-technology platform in drayage, the overall achievement ratings are based on the <u>lowest criterion score</u> for each feasibility parameter.</p> | | |

Looking Forward

As described in this report, all of the major truck OEMs and several new market entrants are developing ZE truck platforms. Of particular importance is that at least one major Class 8 truck OEM plans to begin offering a ZE battery-electric Class 8 truck by 2021, and additional OEMs have similar timelines. Examples of announcements by major Class 8 truck OEMs regarding ZE battery-electric truck offerings in the 2021 timeframe (and beyond) include the following:

- Daimler Trucks reportedly plans to enter into full-scale production of its Class 8 BE e-Cascadia truck by 2021.
- Navistar has announced its intention to commercialize and sell large numbers of battery-electric Class 8 trucks by 2025, although Navistar has not yet provided vehicle specifications.
- Volvo intends to sell battery-electric heavy-duty trucks in North America after an initial (2019) launch in Europe. (**Note:** at the time this report was being published, Volvo had just announced its intention to commercialize a battery-electric version of its VNR Class 8 truck in 2020.)
- Tesla has announced plans to commercialize a high-performance, long-range battery-electric tractor that – if able to achieve the claimed performance and cost metrics – could fundamentally improve the broad feasibility of ZE battery-electric platforms in drayage.

2018 Feasibility Assessment for Drayage Trucks –
Executive Summary

Similarly, strong progress is being made to build, test and eventually mass-manufacture Class 8 trucks powered by ZE hydrogen fuel cell systems. These include the following efforts:

- Start-up OEM Nikola Motors is testing two different hydrogen fuel cell tractor models, and has received thousands of preliminary produce reservations from major Class 8 trucking fleets.
- Toyota’s decision to design and test heavy-duty hydrogen fuel cell powertrains for Class 8 drayage trucks could significantly augment and/or expedite commercialization of heavy-duty hydrogen fuel cell platforms. Toyota has stated that this is the heavy-duty “powertrain of the future” for on-road goods movement.
- Kenworth (in conjunction with Toyota) is working to develop and eventually commercialize Class 8 trucks powered by hydrogen fuel cell technology.

In summary, all the OEMs (existing and start-up) appear to be developing Class 8 tractors with ZE architectures. These OEMs will achieve true commercialization for such products on timelines that are commensurate with commercial maturity and according to what makes good business sense. The many demonstration programs that are already underway or planned will provide critical new information over the next two years; this will help OEMs and end users better understand technological and commercial maturity of leading ZE platforms, and the associated market dynamics. Over the next three years, if at least some of these OEMs are able to achieve their stated goals on performance and cost metrics – and very critical infrastructure build-outs can move forward in proportion to vehicle rollouts – this could fundamentally improve the commercial availability and broad feasibility of ZE platforms in drayage trucking.

1. Introduction

1.1. Background: Clean Air Action Plan and Clean Trucks Program

In 2006, the Port of Los Angeles and the Port of Long Beach jointly adopted the San Pedro Bay Ports Clean Air Action Plan (CAAP). The CAAP presents an overall strategy to systematically reduce harmful emissions from five key goods movement sectors – ships, trucks, trains, cargo-handling equipment and harbor craft. In November 2017, the Ports jointly adopted the 2017 Clean Air Action Plan (CAAP) Update. The CAAP Update further defined and clarified emissions reduction targets, and the strategies that will achieve those reductions. The current CAAP specifies incremental reduction targets for all key pollutants between 2020 and 2050, and outlines fourteen source-specific strategies to achieve these targets.

The Clean Truck Program (CTP) was designed in the original CAAP to generate truck-related emissions reduction strategies under the CAAP. Since 2006, the CTP has reduced emissions from harbor trucks by more than 90 percent; this was accomplished three years ahead of schedule. Under the 2017 update, the CTP was further refined to continue systematically reducing truck emissions. Specifically, it called for an accelerated timeline to transition the San Pedro Bay Ports drayage fleet to adopt zero- or near-zero-emission trucks. Extensive details about the overarching CAAP – and specifically how the CTP will phase in cleaner trucks over time – are available on the CAAP website at <http://www.cleanairactionplan.org/strategies/trucks/>.

1.2. Origin and Framework for CAAP Feasibility Assessments

The 2017 CAAP Update incorporated appropriate checks and balances designed to help ensure that the various control measures are achievable, both technologically and economically. This includes a provision for the Ports to conduct separate “feasibility assessments” for drayage trucks and terminal equipment. Each assessment is intended to evaluate the status of zero-emission (ZE) and near-zero-emission (NZE) fuel-technology platforms (see **Definitions** callout box) – including supporting fueling infrastructures – for their feasibility and timeline to replace conventional, higher-emitting diesel-fueled platforms that currently dominate goods movement activities.

The ultimate objective is to ascertain which (if any) ZE and/or NZE goods movement platforms are now (or will soon be) “feasible” (see **Evaluating Feasibility** callout box) to fully perform goods movement at the Ports, while also systematically and sufficiently reducing harmful emissions in line with aggressive CAAP goals. Because market

Definitions: Zero-Emission (ZE)
vs. Near-Zero-Emission (NZE)

A **zero-emission (ZE)** fuel-technology platform for Class 8 trucks has not yet been formally defined by CARB or EPA. For purposes of this assessment, ZE refers to any fuel-technology combination for Class 8 trucks that *does not directly emit any regulated pollutants*. Effectively, this eliminates any platform that utilizes onboard fuel combustion.

A **near-zero-emission (NZE)** fuel-technology platform has not yet been formally defined by CARB or EPA.* For purposes of this Assessment, NZE refers to any fuel-technology combination for Class 8 trucks that is *significantly lower emitting on oxides of nitrogen (NOx) than the federal 2010 emissions standards for heavy-duty engines*.

*As noted in the 2017 Clean Air Action Plan Update, the Ports have proposed to implement rates and registration requirements following the promulgation of a formal NZE standard by CARB. CARB is expected to establish the allowable emission level for NZE truck engines in 2019. CARB will also be responsible for certifying whether or not particular truck engines developed by various manufacturers meet this emission level. The Ports will rely on these certifications as the determination of whether or not particular engines are considered to emit at near-zero emission levels.

2018 Feasibility Assessment for Drayage Trucks –
Section 2: Overview of 2018 Feasibility Assessment for Drayage Trucks

conditions and technology landscapes can change rapidly, the CAAP calls for the Ports to conduct each feasibility assessment at least once every three years (triennially), and more frequently if necessary.

Evaluating Feasibility

For purposes of this Assessment, *feasibility* refers to the ability of alternative fuel/technology drayage trucks to provide similar or better performance and achievement across five key parameters, as compared to today's baseline diesel drayage trucks. Specifically, per the Ports' "Framework for Clean Air Action Plan Feasibility Assessments," the following five parameters have been applied to collectively assess and evaluate overall feasibility: 1) commercial availability, 2) technical viability, 3) operational feasibility, 4) infrastructure/fuel availability, and 5) economic workability. For each of these parameters, feasibility has been evaluated within the context of *widespread deployment* in all types of drayage trucking at both San Pedro Bay Ports. See Section 4 for additional discussion.

2. Overview of 2018 Feasibility Assessment for Drayage Trucks

2.1. Overall Methodology and Anticipated Outcomes

This report provides the 2018 Drayage Truck Feasibility Assessment; it is the inaugural effort to characterize the status of ZE and NZE fuel-technology platforms that are (or may soon be) suitable to power Class 8 trucks operated in drayage service at the San Pedro Bay Ports. As with each of the Ports' joint assessments, its fundamental purpose is to help the Ports continue making sufficient and timely progress to meet CAAP goals.

To prepare this Assessment, the authors reviewed and analyzed available information deemed to be relevant and credible (see further discussion below), while applying feasibility parameters and boundaries as defined by the "Framework" document footnoted above. This was used to derive a near-term feasibility "snapshot" (2018 to 2021) about the ability for emerging ZE and/or NZE drayage truck platforms to replace conventional, higher-emission diesel trucks. Where emerging platforms currently fall short of this bar, this report summarizes progress being made for them to become feasible, and the challenges that remain before this is likely to be achieved.

With all of this information gathered and assessed, the Ports can best 1) focus attention, resources and support on specific areas that need the most attention, and 2) determine if the CAAP's initial timelines for drayage trucks will need to be adjusted. Examples of specific potential outcomes from this 2018 Feasibility Assessment for Drayage Trucks include the following actions the Ports could take:

- Further develop strategies needed to enable large-scale deployment of ZE and/or NZE drayage trucks; these could include expansion of technology demonstrations, funding programs, and infrastructure installation.
- Issue advisories and/or guidance documents to drayage trucking companies, including potential ways to provide additional flexibility while still meeting CAAP deadlines.

2.2. Timeline, Applicability, Scope and Limitations

The following provides important information about the timeline, scope and applicability of this Assessment:

2018 Feasibility Assessment for Drayage Trucks –
Section 2: Overview of 2018 Feasibility Assessment for Drayage Trucks

Relevant Timeline – This report represents a snapshot in time. It will be updated by late 2021, or sooner if important new information becomes available.² Through the public process to engage stakeholders, and by continuing to consult with technical experts, the Ports will continue to refine the scope and content of each feasibility assessment.

Breadth of Application – This report evaluates the feasibility of emerging drayage truck platforms in terms of their potential for *widespread deployment* (within approximately three years) by all drayage trucking companies and independent owners-operators (IOOs) that legally provide drayage service within the San Pedro Bay Ports complex. The Ports recognize that some emerging platforms may be feasible solely in select circumstances (e.g., where unique operational, infrastructure, and/or financial conditions exist), compared to the overall San Pedro Bay Ports complex. Such situations are recognized and discussed, particularly as they pertain to potential for broader application.

Assessed Types of Drayage – The San Pedro Bay Ports’ drayage truck fleet is utilized in three basic types of service to move cargo to and from marine terminals: 1) near-dock service (approximately six to eight miles one way), 2) local / railyard service (eight to 20 miles), and 3) regional service (20 to 120 miles)³. The energy and power needs for a given drayage trip will vary depending on the specific application and duty cycle. For example, near-dock drayage may involve extensive low-speed, low-load driving compared to regional warehouse hauling, while not requiring as much on-board energy storage – even though both may be transporting a twenty-foot container of similar weight. To the extent that it is relevant, this report attempts to account for these differences, and characterize important nuances that impact the overall feasibility of each drayage truck fuel-technology platform. However, it is important to recognize that trucking companies – or licensed motor carriers (LMCs) – in the drayage registry currently do not have special fleets to focus on a specific type of drayage service. In today’s system, the same truck may be dispatched to perform near-dock, rail or regional service, each with a very different duty cycle.⁴ In the future, the fleet could evolve to become more specialized, e.g. a sub-fleet of ZE trucks could move cargo exclusively on shorter-range routes in communities that are disproportionately impacted by harmful local emissions.

Assessed Fuel-Technology Platforms – This report uses the same basic parameters and criteria (described further) to assess and compare the following five basic emerging ZE and NZE fuel-technology platforms:

1. **ZE** Battery electric (charged while stationary via conductive or inductive infrastructure) or direct-grid electric (electricity provided via a catenary)
2. **ZE** Hydrogen fuel cell electric (electricity generated onboard by reacting hydrogen and oxygen from air; typically hybridized with a battery pack for peak power and regenerative braking)
3. **NZE** Advanced diesel internal combustion engine (ICE)
4. **NZE** Advanced natural gas or propane ICE
5. **NZE** Hybrid-electric (electric drive hybridized with an ICE (using any fuel); may or may not include plug-in capability)

² San Pedro Bay Ports, “2017 Clean Air Action Plan Update,” November 2017, <http://www.cleanairactionplan.org/documents/final-2017-clean-air-action-plan-update.pdf>.

³ San Pedro Bay Ports, “Zero/Near-Zero Emissions Drayage Truck Testing & Demonstration Guidelines,” July 2016.

⁴ See for example the National Renewable Energy Laboratory’s “Heavy-Duty Vehicle Port Drayage Drive Cycle Characterization and Development,” October 2016, <https://www.nrel.gov/docs/fy16osti/66649.pdf>.

2018 Feasibility Assessment for Drayage Trucks –
Section 2: Overview of 2018 Feasibility Assessment for Drayage Trucks

Note: As of late-2018, the five basic architectures noted above (with possible variations) currently exhibit the best potential to be commercially deployed in drayage trucks within the timeframe of this assessment. However, other fuel-technology platforms are not explicitly excluded for this 2018 Assessment (or subsequent assessments). For example, electric-drive platforms may include some type of “range-extender” technology. One example is a ZE battery-electric architecture that uses a smaller battery pack (for reduced weight and/or cost and quicker charging time), augmented by a range-extending fuel cell stack. Another example is a NZE hybrid architecture that provides a limited number of “zero-emission miles” (e.g., in and around boundaries of the Ports), but still relies on a low-emission combustion engine.

Uncertainties and Inherent Challenges – Over the last few years, heavy-duty ZE and NZE fuel-technology platforms with proven or potential use in drayage trucks have been undergoing rapid development. This presents a dynamic situation in which information from available and acceptable sources can suddenly become outdated. To the extent possible, such factors have been taken into account in this Assessment, and reasonable attempts have been made to incorporate emerging developments as they occur. It is possible, albeit unlikely, that one or more fuel-technology truck platforms that *are not yet demonstrated in drayage applications* could emerge as “feasible” within this Assessment’s relatively near-term timeframe.

2.3. Selection of Credible Information Sources

To accurately assess feasibility of emerging ZE and NZE drayage truck platforms, it is imperative to obtain and apply credible information across all input parameters. The previously described “Framework” document provides guidance for this process by giving specific examples of credible information sources. It notes that such an approach “ensures consistency with previous studies that have already been publicly vetted and reviewed by technical experts.”⁵

Following this template, the authors utilized an array of credible and relevant information sources to prepare the 2018 Feasibility Assessment for Drayage Trucks. This includes existing reports prepared by the two Ports under their joint Technology Advancement Program (TAP), as well as outside technical reports by appropriate agencies, which include the U.S. Environmental Protection Agency (EPA), the California Air Resources Board (CARB), the California Energy Commission (CEC), and the South Coast Air Quality Management District (SCAQMD). Where appropriate, reports from industry stakeholders such as Class 8 truck original equipment manufacturers (OEMs), fuel providers, and end users (trucking companies and/or their associations) were also utilized. In addition, the authors gathered direct, real-time inputs by 1) interviewing CARB, SCAQMD and CEC staff; and 2) using survey instruments to query heavy-duty truck OEMs, technology providers and end users. More details about the specific sources of information that have been utilized are provided throughout this report, including references found in tables, figures and footnotes.

In the preparation of this report, it was equally important to define boundaries for acceptable information and data sources. Table 1 presents the general types of information sources that were deemed unacceptable as references in the preparation of this 2018 Drayage Trucking Feasibility Assessment.

⁵ San Pedro Bay Ports, “Framework for Developing Feasibility Assessments”, November 2017, page 3.

2018 Feasibility Assessment for Drayage Trucks –
Section 3: Overview of the Existing San Pedro Bay Ports Drayage Fleet

Table 1. General types of unacceptable information / data sources for 2018 Feasibility Assessment

| Unacceptable Types of Information/Data Sources for 2018 Feasibility Assessment |
|---|
| <ul style="list-style-type: none"> • Unsourced reports • Personal accounts or anecdotes (unless provided by individuals verified to be involved in an official capacity with at least one “Information Source” identified in Appendix A: Criteria for Acceptable Data Source) • Policy advocacy documents without verifiable data/sources to support claims • Fuel additives and/or devices that have not been fully evaluated and verified by CARB, including a multimedia evaluation • Material lacking sufficient information to be judged credible, verifiable, and/or relevant by Port CAAP representatives and/or TAP advisors |

3. Overview of the Existing San Pedro Bay Ports Drayage Fleet

3.1. Late-2018 Snapshot by Key Fuel-Technology Types

As of late-2018, there are approximately 17,500 registered Class 8 trucks in the San Pedro Bay Ports’ drayage fleet. Figure 1 provides a snapshot (July 2018) for this fleet by engine model year (MY). As can be seen, little more than half of these active trucks are powered by engines that are MY 2010 or newer.

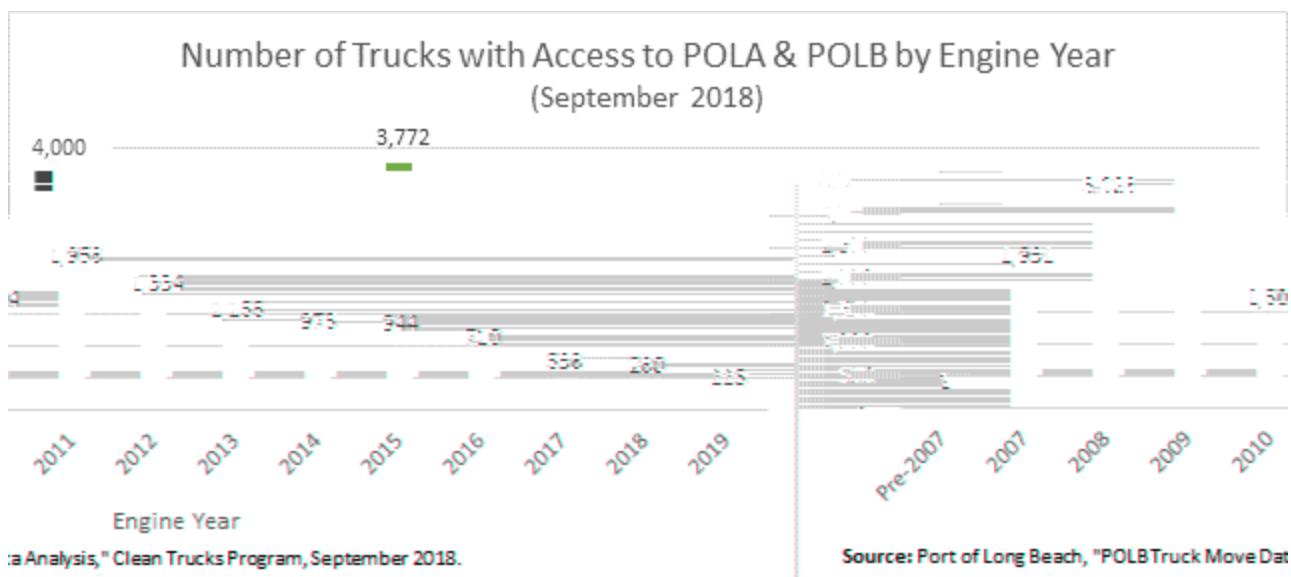

Figure 1. San Pedro Bay Ports drayage truck fleet constitution by engine model year

It is noteworthy that significantly fewer than 17,500 trucks actively perform drayage on any given day. The active fleet ranges from approximately 11,000 up to 13,000 drayage trucks, due to seasonal demand changes and other factors.

Today’s San Pedro Bay Ports drayage fleet continues to be dominated by conventional Class 8 trucks powered by heavy-duty diesel-fueled ICEs. So far, natural gas heavy-duty ICE trucks are the only non-diesel-fueled platform that has significantly penetrated into this fleet. As Figure 2 shows, natural gas trucks -- mostly equipped with Liquefied Natural Gas (LNG) fuel storage systems (see callout box) -- constituted about eight percent of the active drayage fleet (~960 trucks) during the peak period from 2010 to 2013. This has gradually been reduced over the last five years, and today natural gas drayage trucks constitute about three percent of the San Pedro

2018 Feasibility Assessment for Drayage Trucks –
Section 3: Overview of the Existing San Pedro Bay Ports Drayage Fleet

Bay Ports drayage fleet. The gradual reduction in this percentage is largely due to normal attrition of older-model natural gas trucks, most of which had undersized engines for drayage service (further described below).

Liquefied Natural Gas (LNG) vs. Compressed Natural Gas (CNG): Heavy-duty natural gas vehicles (including Class 8 drayage trucks) can run on either CNG or LNG (see <https://www.nrel.gov/docs/fy09osti/42946.pdf> for additional details). At the time of the original CAAP, the primary form of fuel storage for heavy-duty natural gas trucks was LNG. However, the heavy-duty market in recent years has trended away from LNG. Given the trend toward greater use of CNG over LNG, the calculations that follow in this study are primarily based on CNG Class 8 trucks. Notably, the natural gas used in CNG trucks can come from the pipeline and be compressed at the station site, or it can be delivered as LNG and converted to CNG at “liquefied-compressed natural gas” (LCNG) stations.

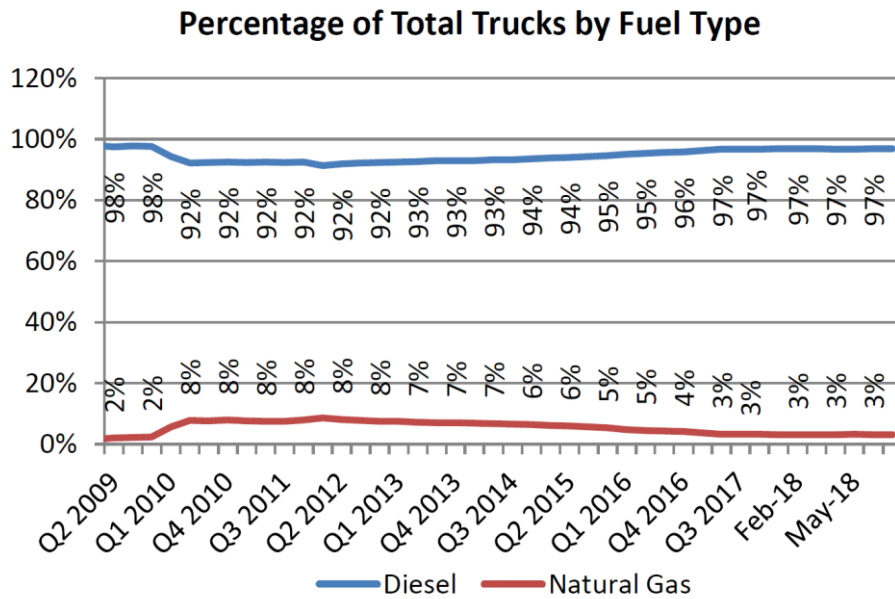

Source: Port of Long Beach, "POLB Truck Move Data Analysis," Clean Trucks Program, September 2018.

Figure 2. Running percentages of diesel and natural gas trucks in the drayage fleet, 2009 to 2018

The vast majority of Class 8 natural gas trucks in the San Pedro Bay Ports drayage fleet were factory-equipped with the Cummins-Westport ISL G engine. With a displacement of just nine liters and relatively low horsepower and torque (~320 HP/1,000 lb-ft torque), this engine was somewhat undersized for Class 8 drayage applications⁶ compared to typical diesel engines used in Class 8 trucking applications. Until about 2015, the ISL G was the only heavy-duty natural gas engine available for Class 8 trucking. In 2015, CWI commercially introduced its ISX12 G natural gas engine. This larger-displacement (12-liter) natural gas engine offered improved performance (400 HP / 1,450 lb-ft torque) that is well-suited for a variety of heavy-duty vehicle applications, including regional-haul drayage trucking.

⁶ Cummins Westport International (CWI) indicates that the “natural choice” for its ISL G in trucking was “vocational and medium-duty” applications” rather than Class 8 tractor applications like drayage. CWI recently replaced the ISL G for North American markets with its L9N engine.

2018 Feasibility Assessment for Drayage Trucks –
Section 3: Overview of the Existing San Pedro Bay Ports Drayage Fleet

In 2018, CWI replaced the ISL G and the ISX12 G with its L9N and ISX12N natural gas engines, respectively. Both of these CWI heavy-duty natural gas engines are certified to CARB’s lowest-tier Optional Low-NOx Standard (OLNS) of 0.02 g/bhp-hr. As such, they are certified at a NOx level 90 percent lower than the most-stringent federal or California NOx emission standard for heavy-duty engines. The only other OEM heavy-duty engine certified to CARB’s lowest-tier OLNS of 0.02 g/bhp-hr is fueled by propane (the Roush Cleantech V10 3v engine). This engine is designed for medium-duty trucking applications, and is not suitable for drayage service. The significance of CWI’s 12-liter heavy-duty natural gas engine being certified to 0.02 g/bhp-hr NOx is further discussed in subsequent sections.

3.2. Drayage Fleet Size

To make estimates about infrastructure needs, vehicle availability, and cost for this Assessment, it is important to understand the maximum and minimum size requirements for the drayage fleet. Several approaches have been used to develop a range for the required drayage fleet. An upper end bound was set based on the number trucks currently registered in the San Pedro Bay Ports Drayage Truck Registry (PDTR). As of August 2018, the number of trucks with access to either port stood at 17,606. In 2017, the maximum number of registered trucks reached 17,943. Therefore, an upper-end estimate of the maximum fleet size can be set at approximately 18,000 trucks.

Determining the lower bound of the drayage fleet size is more challenging. The drayage fleet undergoes day-to-day and seasonal variations in cargo throughput, as well as longer-term changes in baseline cargo throughput. Consequently, single day or single month maximum truck volumes do not necessarily reflect the number of individual trucks required. Additional insight can be gained by reviewing the number of trucks by frequency of container moves. As shown in Figure 3, there are approximately 6,000 frequently calling trucks regularly serving the Ports (more than five moves per weekday). Additionally, between 6,000 and 8,000 semi-frequent trucks (2.5 to 5 moves per weekday) and 1,500 to 2,500 infrequent trucks (less than 2.5 moves per weekday) serve the Ports.

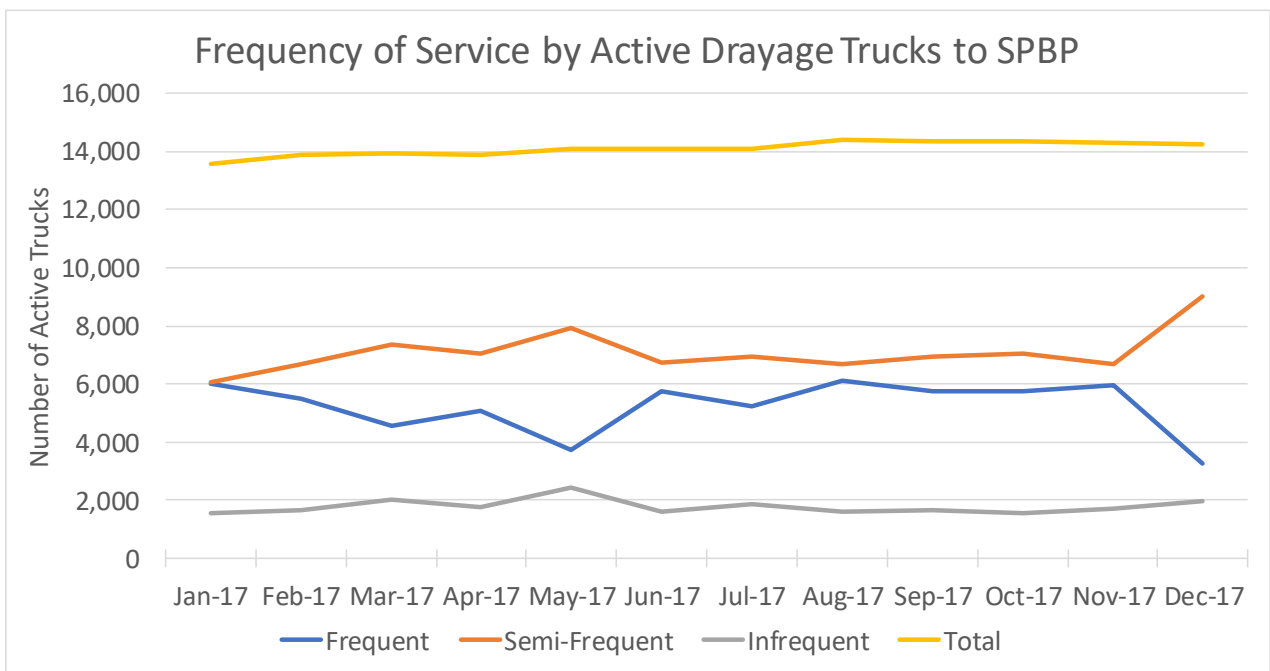

Source: Port of Long Beach, "POLB Truck Move Data Analysis," Clean Trucks Program, July 2018.

Figure 3. Active drayage trucks serving the San Pedro Bay Ports, 2017

2018 Feasibility Assessment for Drayage Trucks –
Section 3: Overview of the Existing San Pedro Bay Ports Drayage Fleet

The above figure shows that there is a clear relationship between frequent and semi-frequent callers: frequent callers transition to-and-from semi-frequent callers on a roughly one-to-one basis. This implies that when there is sufficient work, semi-frequent callers become frequent callers. The number of infrequent callers remains relatively constant. If it is assumed that a frequent caller makes twice as many daily moves as a semi-frequent caller, then roughly half of the semi-frequent callers would be transitioned to frequent callers at a given monthly cargo volume. Using this approach, it is estimated that the minimum fleet size would be approximately 11,000 trucks at current cargo volumes. This yields a range from 11,000 to 18,000 trucks as a rough estimate for the required size of the drayage fleet.

3.3. Drayage Operational Requirements

To assess the various components of feasibility, it was important to first understand key operational metrics associated with the drayage vocation at the San Pedro Bay Ports. As described in greater detail in Section 7, existing studies and a new survey of drayage operators were used to develop a definition of operational requirements for drayage trucks to be used in this Assessment. In practice, the drayage market cannot be defined as a single set of operating parameters applicable to every truck. Drayage is a continuum of daily operational needs that varies across the entire drayage fleet. Therefore, to inform this Assessment, the concept of a “broadly applicable truck” (BAT) was developed to assist in assessing the Operational Feasibility parameter. A BAT is defined as being capable to perform the vast majority of drayage operations in the San Pedro Bay Ports’ fleet, and is described by the Minimum Operational Capabilities Needed, shown in Table 2. Average Operational Assumptions shown in Table 2 are used primarily to inform the economic and infrastructure analyses and to guide assessment of the Technical Viability parameter, as further defined below and in Section 6.

Table 2. Operational assumptions for a "Broadly Applicable Truck" (BAT)

| Operational Parameter | Units | Value |
|--|---------|--|
| <i>Minimum Operational Capabilities Needed</i> | | |
| Maximum Shift Distance | miles | 600 |
| Maximum Shifts per Day | #/day | 2 |
| Maximum Daily Mileage | miles | 800 |
| Maximum Weight (GCWR) | lbs | 80,000 |
| Top Speed (0% grade) | mph | 60 |
| Gradeability @0 mph | % grade | 15% at 80,000 lbs |
| Gradeability @40 mph | % grade | 6% at 80,000 lbs (short distance bridge climb) |
| Gradeability @35 mph | % grade | 6% at 57,000 lbs (sustained) |
| # of Shifts between charging/fueling | | 2 shifts with less than 5 hours for charging/ fueling, or 1 shift with diesel-like fueling times |
| <i>Average Operational Assumption for Economic and Infrastructure Analyses</i> | | |
| Average Shift Distance | miles | 160 |
| Average Shift Duration | hours | 9.9 |
| Average Shifts per Day | #/day | 1.6 |
| Average Daily Operating Time | hours | 14.8 |
| Average Daily Mileage | miles | 238 |

4. Applied Parameters and Initial Screening of Leading Fuel-Technology Platforms

This 2018 Drayage Truck Feasibility Assessment applied five key parameters to examine which (if any) emerging ZE and/or NZE fuel-technology platforms for Class 8 trucks are demonstrably capable of and ready for broad deployment in drayage service at the Ports. The five feasibility parameters – which were outlined in the previously described “Framework” document – are as follows:

- Commercial Availability
- Technical Viability
- Operational Feasibility
- Infrastructure Availability
- Economic Workability (Key Economic Considerations and Issues)

All five of these parameters interact to collectively define feasibility. Failure to meet any one parameter could present a significant barrier to *wide-scale* deployment at the Ports. The first two parameters seem especially important to achieve, or at least approach achievement. Specifically, to be ready for near-term, large-scale deployment (i.e., thousands of units), a given drayage truck platform 1) needs to exist as a fully certified commercial product, and 2) must be technically capable to perform all necessary drayage duties in a reliable, safe and effective manner, as described in the Framework document previously referenced.

Thus, the two feasibility parameters of Commercial Availability and Technical Viability were used to initially screen leading ZE and NZE fuel-technology platforms that appear capable of powering Class 8 drayage trucks. All fuel-technology platforms shown to meet basic considerations for these two parameters (while applying noted guidelines, and within a three-year timeframe) were then further assessed, according to the three remaining feasibility parameters (Operational Feasibility, Infrastructure Availability and Economic Workability). The schematic in Figure 4 depicts this basic screening procedure.

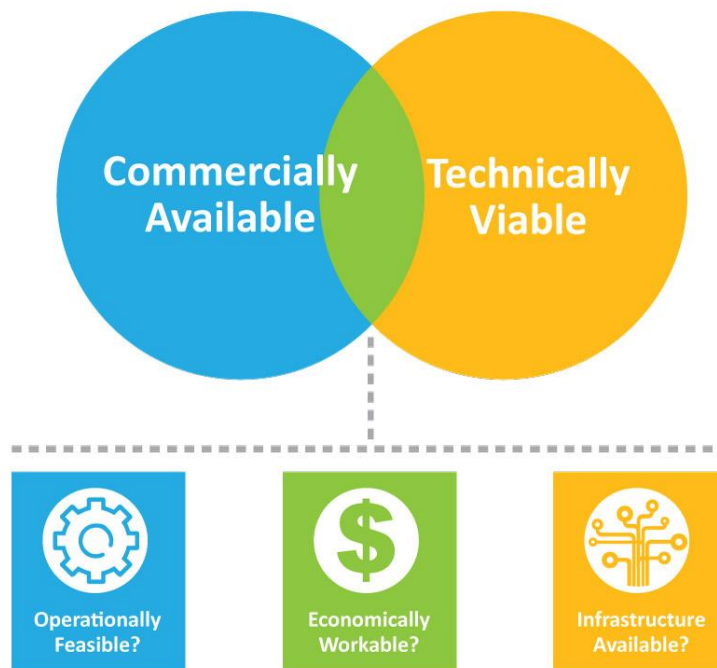

Figure 4. General screening procedure for applying feasibility parameters to assess fuel-technology platforms

2018 Feasibility Assessment for Drayage Trucks –
Section 4: Applied Parameters and Initial Screening of Leading Fuel-Technology Platforms

Note: It is important to repeatedly stress that this 2018 Feasibility Assessment for Drayage Trucks represents a snapshot in time. The technology and economic landscapes for clean heavy-duty transportation technologies can change rapidly. ZE and/or NZE drayage truck platforms that do not yet warrant deeper analysis (as of late-2018) could still exhibit rapid advancement and development. Recognizing this potential, the Ports intend to prepare the next feasibility assessment for drayage trucks within about three years, or sooner if warranted by accelerated technological progress, significant expansion in commercial platforms, improving economics, etc.

5. Assessment of Commercial Availability

5.1. Background: Criteria and Methodology

Based on the Framework document, an emerging ZE or NZE fuel-technology drayage truck platform is deemed to be commercially available when (1) it is being manufactured in large quantities and within similar timeframes as the baseline equipment (Class 8 diesel ICE tractors), and (2) it has baseline-equivalent customer support systems for vehicle warranty, maintenance, and parts. Using additional guidance from the Framework document, specific criteria have been identified to collectively define if these two basic tests are met. Table 3 summarizes these commercial availability criteria and their base considerations.

Table 3: Criteria and base considerations used to evaluate Commercial Availability

| Commercialization Criteria/Issue | Base Considerations for Assessing Commercial Availability |
|---|--|
| Production and Sales with Major OEM Involvement | Production and full certification by either a major Class 8 truck OEM or by a proven technology provider that has partnered with the major OEM. |
| Proven Network / Capabilities for Sales, Support and Warranty | Demonstrated existing (or near-term planned) network of sufficient dealerships to sell and service existing or expected drayage truck demand. |
| | Demonstrated ability to sell ZE and/or NZE Class 8 trucking platforms that are equivalent to baseline diesel Class 8 trucks (full warranty provisions, long-term support for maintenance and parts replacement). |
| Sufficient Means and Timeline for Production | Demonstrated capability to manufacture sufficient numbers of Class 8 trucks (suitable for drayage) within a timeline to meet existing or expected demand. |
| Existence of Current and/or Near-Term Equipment Orders | Demonstrated backlog of Class 8 truck orders, or credible expression of interest from prospective customers to submit near-term orders. |
| Source: Based on criteria in San Pedro Bay Ports’ “Framework for Developing Feasibility Assessments,” November 2017. | |

5.2. Production with Major OEM Involvement

A common denominator among the criteria above is the paramount role that major heavy-duty truck OEMs must play to develop, fully certify, sell and support large numbers of ZE and/or NZE drayage trucks. (It is also recognized that many of these major OEMs are working with, and relying upon, smaller-volume start-up OEMs, technology providers and qualified “upfitters” to help accelerate technological progress and incorporate alternative fuel systems into various ZE and NZE platforms.) Two key sources were used to gather and summarize the current status of major OEM involvement in these markets: 1) surveys sent to senior OEM representatives (allowing anonymous responses), and 2) public statements and information released by the OEMs. Further details and findings are described below.

5.2.1. Surveys Sent to Heavy-Duty Truck OEMs

In mid-2018, surveys were prepared and sent to senior-level representatives from existing, emerging and potential OEMs of Class 8 heavy-duty trucks. All six major existing Class 8 truck OEMs – as well as four start-up or emerging heavy-duty truck OEMs – received the survey questions (see Appendix C). The objective was to provide these OEMs with opportunity to anonymously⁷ describe 1) their existing or near-term-planned product offerings that

⁷ These existing and emerging OEMs were asked to provide non-proprietary answers and information. To help encourage a high rate of response and facilitate frank inputs, it was communicated to the OEMs that their information and inputs would be treated as anonymous, i.e., without attribution to any specific OEM or company representative.

2018 Feasibility Assessment for Drayage Trucks –
Section 5: Assessment of Commercial Availability

incorporate ZE or NZE fuel-technology platforms (as previously defined); and 2) how they perceive opportunities, challenges, and timelines associated with a potential major new market for Class 8 ZE and NZE drayage trucks at the San Pedro Bay Ports.

This survey was sent to a total of 10 relevant OEMs of varying types. As shown in Table 4, six are categorized as **major existing truck OEMs**, three are categorized as **emerging truck OEMs**, and one is categorized as an **emerging drivetrain OEM**.⁸

Table 4: Class 8 OEMs / suppliers receiving survey on ZE/NZE products, opportunities and challenges

| Company Name | Role in Manufacturing Class 8 Trucks |
|--|--|
| Freightliner (Daimler Trucks North America) | Major Existing Class 8 Truck OEM |
| Volvo Group North America | |
| Mack Trucks | |
| Kenworth | |
| Peterbilt Motor Co. | |
| Navistar, Inc. | |
| BYD | Emerging Class 8 Truck OEM |
| Nikola Motor Co. | |
| Tesla, Inc. | |
| Toyota USA | Emerging Class 8 Drivetrain OEM |

All six of the major existing Class 8 truck OEMs – and two of the four emerging OEMs – provided written responses to the survey questions. As expected, most of the responding companies did not answer all questions, and significant variation was received regarding which questions they addressed. Nonetheless, the information provided by the eight responding companies helped to compile a profile about how Class 8 truck OEMs currently perceive ZE and NZE heavy-duty truck markets (existing and potential products, opportunities, challenges and risks).

Table 5 summarizes the input received from the eight responsive Class 8 truck OEMs when asked to quantify the number of models they sell today that are based on ZE and/or NZE platforms. The OEMs also listed the number of models sold today that are baseline diesel ICE trucks (i.e., not a ZE or NZE platform).

Table 5: Summary of responses from surveyed Class 8 OEMs about current (2018) commercial offerings

| Truck Configuration | Baseline Diesel ICE | ZE Battery-Electric | ZE Fuel Cell | NZE Natural Gas (ICE) | NZE Advanced Diesel (ICE) | NZE Hybrid Electric* |
|--|-----------------------|----------------------|----------------------|-----------------------|---------------------------|----------------------|
| Day Cab | 12 Models (5 OEMs) | 2 Models (2 OEMs) | 1 Model (1 OEM) | 7 Models (4 OEMs) | 0 Models (0 OEMs) | 0 Models (0 OEMs) |
| Sleeper Cab | 11 Models (5 OEMs) | 0 Models (0 OEMs) | 0 Models (0 OEMs) | 5 Models (3 OEMs) | 0 Models (0 OEMs) | 0 Models (0 OEMs) |
| Source: GNA survey of major existing and emerging Class 8 OEMs, July 2018. | | | | | | |
| * Electric drive hybridized with an ICE (any fuel); may or may not include plug-in capability. | | | | | | |

⁸ The same survey was also sent to three different “technology providers” of ZE and/or NZE drive systems that could be incorporated into commercial Class 8 ZE trucks. Each of these providers – TransPower, US Hybrid and Meritor – are working with at least one of the existing or emerging OEMs described above. To avoid double counting, their responses to the survey are not independently reported.

2018 Feasibility Assessment for Drayage Trucks –
Section 5: Assessment of Commercial Availability

As the above table shows, the eight responding Class 8 truck OEMs (major existing and start-up) reported the following about their relevant products:

- **Baseline Diesel ICE**⁹: 5 OEMs sell a total of 23 day cab and sleeper cab models
- **ZE Battery-Electric**: 2 OEMs sell a total of 2 models (both day cabs)
- **ZE Fuel Cell**: 1 OEM sells 1 model (day cab)
- **NZE Natural Gas ICE**: 4 OEMs sell a total of 12 day cab and sleeper cab models¹⁰
- **NZE Advanced Diesel ICE**: no OEMs are selling any models
- **NZE Hybrid Electric** (ICE/electric drive, with or without plug-in capability): no OEMs are selling any models

It is important to distinguish between Class 8 trucks that clearly constitute commercial (including “early commercial”) products today (i.e., they meet all the basic considerations described in this section), versus those that are in a proof-of-concept, pre-commercial stage of development. This is further discussed below, and specifically in the context of demonstration programs (see Section 5.6)

5.2.2. OEM Public Announcements, Statements and Literature

In addition to the above input that was obtained anonymously from existing and startup OEMs, public statements and literature disseminated by the OEMs were reviewed and tallied. Table 6 below summarizes public statements by the seven cited heavy-duty truck OEMs (late-2018) regarding the ZE and/or NZE Class 8 tractors that they market and sell today. In the last column, driving ranges have been estimated based on OEM specifications. Section 7 (Operational Feasibility) provides additional discussion about this important parameter of driving range.

Table 6. Snapshot of commercial offerings by OEMs for ZE or NZE Class 8 Trucks, by platform type

| Make | Model | ZE Battery-Electric | ZE Fuel Cell | NZE Hybrid Electric | NZE CNG | NZE LNG | Estimated Range** (mi.) |
|-------------------------------|---------------|---------------------|--------------|---------------------|---------|---------|-------------------------|
| BYD | 8TT (T9/Q3M) | ✓ | ✗ | ✗ | ✗ | ✗ | 125 to 220 |
| Freightliner (Daimler) | Cascadia | ✗ | ✗ | ✗ | ✓ | ✓ | 400 to 1,000 |
| Kenworth | T440 or T680 | | | | | | |
| Mack | Pinnacle | | | | | | |
| Navistar Inc. | Transtar 8600 | | | | | | |
| Peterbilt* | Model 579 | | | | | | |
| Volvo | VNL 300 | | | | | | |

Source: OEM websites and publicly available literature
 *Peterbilt Model 579 is built on Meritor axles, drivelines and brakes, with TransPower’s electric drivetrain and controls. Meritor invests in TransPower and is the exclusive distributor of these systems.
 **Estimated range is based on the following assumptions for typical fuel capacities and platform-specific fuel efficiencies (baseline diesel included for comparison purposes):

- **Baseline Diesel:** Fuel economy 6.0 to 7.0 mpg. Fuel tank capacity 75 to 150 gallons. Range 450 to 1,050 miles
- **Battery Electric:** 2.0 to 3.5 kWh/mi. Battery capacity based on OEM specifications.
- **CNG/LNG:** Fuel economy 90% of diesel. Fuel tank capacity 75 to 160 DGE.

⁹ As implied by “baseline,” heavy-duty diesel engine technology does not meet the “NZE” definition for this Feasibility Assessment. Promising engine development efforts are underway, however. See the Technical Viability section for additional discussion.

¹⁰ Cummins Westport notes that five major truck OEMs (Freightliner, Kenworth, Mack, Peterbilt, and Volvo) now offer the 12L near-zero natural gas engine. (Cummins Westport comments on draft Feasibility Assessment, January 31, 2019)

2018 Feasibility Assessment for Drayage Trucks –
Section 5: Assessment of Commercial Availability

Key takeaways from the information in Table 6 include the following:

- Public announcements by these seven heavy-duty truck OEMs about their commercial products are generally consistent with the anonymous responses that were submitted via the OEM survey.
- In both cases, commercial availability of Class 8 ZE and/or NZE truck platforms is dominated by natural gas ICE technology. Specifically, all six major OEMs are offering Class 8 NZE trucks powered by the 12-liter CWI ISX12N engine (as previously described). Each OEM offers options for the volume of on-board natural gas storage, as either CNG or LNG. At the maximum volume of 175 diesel gallon equivalents (DGE), NZE natural gas drayage tractors can provide nearly 1,000 miles of driving range between fueling stops (see Section 7 for the range-related operational needs of drayage fleets).
- Start-up OEM BYD offers the only commercially available battery-electric Class 8 truck (as of late-2018). According to BYD, the 8TT model battery-electric tractor is powered by a 435 kWh battery pack that provides a driving range of 124 miles at full load and 167 miles at half-load.¹¹ (BYD also offers a battery-electric Class 8 refuse truck, as well as Class 5 and 6 battery-electric trucks.) BYD's 8TT Class 8 battery-electric tractor represents a milestone in ZE heavy-duty trucking. This groundbreaking platform is further discussed and analyzed in Section 7, specifically within the context of its use in drayage trucking. In particular, the issue of significantly reduced driving range is an important one for battery-electric trucks used in Class 8 trucking applications, including drayage.

Note: All six mainstream heavy-duty truck OEMs are working to develop, demonstrate and eventually commercialize battery-electric Class 8 tractors that could be used in drayage applications. Several of the OEMs have partnered with start-up OEMs and/or technology providers. Key OEM demonstration efforts are discussed in Section 5.6.

Table 6 does not include information about Class 8 ZE platforms from either Tesla Inc. or Nikola Motors, both of which are start-up OEMs that appear to have good potential to build and sell large numbers of ZE Class 8 trucks. Although these two companies are accepting “orders” from trucking fleets for Class 8 ZE tractors (also see Section 5.5), it is premature to consider their products commercially available as defined in this Assessment. The foundations for this conclusion are described below:

- Tesla has publicly announced it is now taking reservations from fleets to purchase the Tesla “Semi” Class 8 battery-electric tractor. To date, Tesla has mass-produced light-duty battery-electric vehicles, but not heavy-duty electric trucks. It is now demonstrating a small fleet of proof-of-concept Semi models in western U.S. trucking corridors. (As of late 2018, Tesla’s demonstration focus has not been on port drayage applications, but the company appears to be ready to gear its products towards that market.) Concurrently, a number of large trucking fleets have reportedly reserved multiple Tesla Semi trucks (e.g., at least 30 by Walmart). To finalize a reservation for each “Base Option” Tesla Semi, fleets must submit a \$20,000 deposit; \$200,000 (essentially fully price) is required to reserve a limited-production “Founders Series” Tesla Semi.¹² As Tesla states in its reservation Terms & Conditions, deposits are refundable until the prospective customer signs a Tesla purchase agreement. Tesla will then convey the final purchase price of the vehicle(s), plus estimates “for any applicable taxes, duties, transport and delivery charges, and any other applicable fees.”¹³ Tesla does not provide specifics about when production of Semi models will actually begin, although it appears to now be targeted for 2020. Concurrently, CEO Elon Musk has indicated that the company still needs to complete its

¹¹ BYD, sales brochure for Model 8TT Class 8 battery-electric tractor, accessed on October 14, 2018, http://en.byd.com/usa/wp-content/uploads/2018/07/8tt_redesign6-23-18.pdf.

¹² Tesla, Inc., “Reserve the Tesla Semi,” <https://www.tesla.com/teslasemi/reserve>.

¹³ Ibid.

2018 Feasibility Assessment for Drayage Trucks –
Section 5: Assessment of Commercial Availability

production design.¹⁴ Consequently, Tesla’s purchase agreement stipulates that actual delivery dates for reserved trucks “may depend on development, manufacturing and production schedules, among other factors.”¹⁵ In other words, to date it is not accurate to call the Tesla Semi a commercially available product.

- Similar to the Tesla battery-electric case, Nikola Motors has reportedly taken more than 11,500 “pre-order reservations” from fleets for Class 8 tractors (day cab and sleeper models) powered by its fuel cell-battery hybrid system. Nikola will also offer battery-electric Class 8 tractors. This start-up OEM has raised at least \$110 million for launching these commercialization efforts, and has stated its intent to manufacture 35,000 ZE trucks per year by 2025. Many national trucking fleets have reserved either the Nikola One™ (sleeper cab) and/or the Nikola Two™ (day cab) model; Anheuser-Busch has reportedly ordered 800 tractors. However, it is important to remember that these are “no-obligation” orders. Nikola Motors has not stated how long it will actually take to produce and deliver either model, once ordered. The “terms and conditions” Nikola attaches to its reservation system includes the following advisement to fleets:

“You understand that Nikola Motor Company™ may not have completed the development of the vehicle or begun manufacturing the vehicle at the time of your Reservation. Further, you acknowledge that the Nikola Two™ production vehicle may differ from the vehicle presented to you and/or the vehicle you have selected on our website. You also acknowledge that, if you elect to purchase a vehicle, the vehicle will not be delivered until a date that is yet to be determined. You also agree that any representation made by a Nikola™ representative, Nikola™ partner, third party, or agent regarding the vehicle’s production date, delivery date, delivery location, price, options, or similar detail is non-binding on Nikola™.”¹⁶

5.3. Proven Network and Capability for Sales, Service, Parts and Warranty

This Assessment assumes that commercially available ZE and/or NZE drayage trucks must be sold by OEMs that have demonstrated capability to provide essential (diesel-equivalent) support for such emerging products. Specifically, the necessary pre- and post-sales support includes existence of a proven network for selling and servicing the trucks; providing replacement parts; training fleet personnel for new procedures and equipment (including safety related); and providing diesel-equivalent warranty coverage.

Based on the survey responses, those OEMs that already offer ZE and/or NZE platforms are able to meet this basic requirement. A typical response from the six major OEMs was “we would not offer any ZE or NZE truck types on the market that did not have full support, service, and warranty packages.” For them, it is relatively routine to provide these support systems, because they are able to augment or replicate existing systems that have been supporting diesel trucks for decades. For example, in 2018 all the major existing OEMs sell NZE Class 8 natural gas tractors that routinely include diesel-equivalent support across all parameters.¹⁷

It remains to be seen if this can be done on the scale that would be needed for wide-scale use in the San Pedro Bay Ports drayage fleet. Based on past performance, there is no reason to believe that the major OEMs will not be able to meet the basic requirements outlined for this criterion. Notably, for start-up OEMs, it can be complex and costly to establish these systems from scratch. This is probably why one start-up OEM indicated it will use an

¹⁴ Lambert, F., “Watch Tesla Semi get test driven by UPS: ‘one smooth ride’ they say,” Electrek, August 28, 2018, <https://electrek.co/2018/08/28/tesla-semi-test-drive-ups-smooth-ride/>.

¹⁵ Tesla, Inc., “Tesla Semi Reservation Terms & Conditions,” https://www.tesla.com/sites/default/files/TeslaSemi_ReservationAgreement_20171113_en-US.pdf

¹⁶ Nikola Motors, “Nikola Two Reservation / Terms & Conditions,” https://nikolamotor.com/pdfs/Nikola_Two_Reservation_Agreement.pdf

¹⁷ Gladstein, Neandross & Associates, Questionnaire for OEMs of Drayage Trucks, August 2018.

2018 Feasibility Assessment for Drayage Trucks –
Section 5: Assessment of Commercial Availability

established third-party service to provide fleet customers with “all service and support,” including dealer and mechanic training.

Section 7 (Operational Feasibility) provides additional discussion about these important peripheral systems, from the fleet customer perspective.

5.4. Sufficient Means and Timeline for Production

This parameter refers to the ability of heavy-duty truck OEMs to collectively produce sufficient numbers of commercialized ZE and/or NZE Class 8 trucks to enable systematic replacement of the entire San Pedro Bay Ports drayage fleet; this would occur over many years according to normal truck-replacement schedules.

In 2018, only one OEM (BYD) is actually selling a commercially available ZE drayage truck. BYD has not yet demonstrated capability to mass-manufacture hundreds or thousands of battery-electric Class 8 trucks. Numerous demonstration programs are just beginning to deploy ZE drayage trucks (primarily battery-electric) in drayage service (see Section 5.6).

Thousands of heavy-duty vehicles (HDVs) with NZE natural gas engines have been built and deployed in the U.S. over the last two years. However, only about 22 of these are drayage trucks, and they are still undergoing proof of feasibility testing. While the NZE natural gas engine is a fully commercial product, proving the engine in the drayage vocation is the specific intent of the demonstration. It does seem plausible that hundreds more of these NZE natural gas Class 8 trucks could be manufactured and made available for drayage service over the next few years. For example, this is the statement of one mainstream OEM submitted via the OEM survey:

“We are delivering the NZ product already today. We will build and deliver about 700 this year. There is virtually no limit on quantity of deliveries for this product given proper lead times.”¹⁸

In sum, it appears that hundreds of ZE and/or NZE Class 8 tractors could potentially be manufactured and available for port drayage by 2021. However, with respect to ZE platforms, it remains to be seen if sufficient numbers (thousands) could be built in time to replace a large portion of the entire San Pedro Bay Ports drayage fleet. With respect to NZE natural gas platforms, the current manufacturing capacity of North American truck manufacturers and engine supplier Cummins Westport would be sufficient to produce the required units, barring constrained manufacturing capacity from high demand for diesel trucks. Thus, there is some uncertainty if this parameter is fully achievable in the timeframe of this Assessment. However, the Ports recognize that full turnover of the drayage fleet to a mix of ZE and/or NZE fuel-technology platforms will need to occur over a timeframe that exceeds three years.

5.5. Existence of Current and/or Near-Term Equipment Orders

2018 has been a very robust year for U.S. sales of new Class 8 trucks, reaching all-time-high levels. In July 2018 alone, 52,000 Class 8 trucks were ordered by North American fleets; this is nearly triple the number sold in July 2017. The increase in sales is due to a strong economy, combined with other favorable dynamics that have been driving fleets to purchase large numbers of trucks in 2018. All six of the major Class 8 truck OEMs are experiencing record or near-record sales, and most (if not all) have received more orders than they can fill over the next several months.

¹⁸Statement by existing major Class 8 truck OEM, in response to 2018 Questionnaire for OEMs of Drayage Trucks prepared and circulated by Gladstein, Neandross & Associates.

2018 Feasibility Assessment for Drayage Trucks –
Section 5: Assessment of Commercial Availability

While more than 95 percent of these new sales are for conventional trucks powered by diesel internal combustion engines, purchase orders from fleets to buy Class 8 trucks powered by natural gas engines have also been significant, and growing, in 2018.¹⁹ Survey responses from the six existing major Class 8 truck OEMs imply that current orders from their fleet customers for Class 8 natural gas tractors range from “significant” (up to 700 per year), to “limited” because they are “somewhat expensive.”

It is important to consider what constitutes a near-term equipment order for a commercial product. Dealers of major existing OEMs are selling commercial products when they fill ongoing orders from fleet customers over many years, for the same basic types of trucks. However, in cases where orders are accepted for new-technology Class 8 trucks that have not yet been mass produced, the applicable terminology is less well defined. For example, at least three Class 8 OEMs (existing and/or start-up) are actively accepting fleet orders for Class 8 ZE tractors that are probably best characterized as “early commercial” or “pre-commercial” products (see call-out box below):

- **BYD Battery-electric** – According to BYD’s website, fleets can order the BYD 8TT model Class 8 battery-electric day cab tractor. Short-haul drayage trucking is one of the targeted applications for this Class 8 electric tractor.²⁰ Various grant programs in California have recently awarded funds to deploy significant numbers of this platform, including drayage companies serving the two San Pedro Bay Ports (see section 5.6). Awarded under a CARB grant, at least one BYD 8TT has already been delivered, and is now being used to perform drayage at the Port of Oakland. However, this BYD truck is being tested under a three-year feasibility study.²¹ In a limited sense, the 8TT battery-electric tractor is a commercial product available today, and it is possible that drayage fleets have already ordered significant numbers. However, the reality is that this heavy-duty battery-electric platform is just beginning to be deployed in early commercialization demonstrations for drayage service.
- **Tesla, Inc. Battery-electric** – Although not yet in production, Tesla has reportedly received hundreds of pre-orders for its battery-electric Class 8 Semi truck. Major long-haul trucking fleets that have pre-ordered Tesla’s Semi include Walmart, Pepsi, Anheuser-Busch, FedEx, Sysco, UPS, DHL, Ryder, J.B. Hunt, Asko, and several others.²² According to Tesla CEO Elon Musk, the company will initiate production of the Semi in 2020.²³ The Tesla product appears to be in the initial, pre-commercialization stages of development.
- **Nikola Motor Company Fuel Cell Electric** – Nikola is now taking orders for Class 8 heavy-duty tractors powered by its fuel cell electric²⁴ technology. While the final fuel cell technology has not been announced, Nikola appears to be collaborating with Swedish fuel cell developer PowerCell AB. Ryder will reportedly be Nikola’s exclusive distributor and maintenance provider²⁵ for any fleet that orders and purchases Nikola fuel

¹⁹ Lockridge, D., “July Class 8 Truck Orders Set Record,” Truckinginfo.com, August 2, 2018, <https://www.truckinginfo.com/310242/july-class-8-truck-orders-set-record>.

²⁰ BYD website, “Class 8 Day Cab Brochure,” http://en.byd.com/usa/wp-content/uploads/2018/07/8tt_redesign6-23-18.pdf.

²¹ “BYD delivers first battery-electric truck to Port of Oakland,” FleetOwner, May 25, 2018, <https://www.fleetowner.com/running-green/byd-delivers-first-battery-electric-truck-port-oakland>.

²² Matousek, M., “Tesla has a new customer for its electric Semi – here are all the companies that have ordered the big rig,” BusinessInsider, April 25, 2018, <http://www.businessinsider.com/companies-that-ordered-tesla-semi-2017-12>.

²³ Thompson, C., “Elon Musk reveals new details about Tesla’s upcoming Model Y SUV, the Roadster, and the Semi,” BusinessInsider, June 5, 2018, <http://www.businessinsider.com/elon-musk-reveals-tesla-model-y-roadster-and-semi-details-2018-6>.

²⁴ “Fuel cell electric” refers to the common combination of a large fuel cell-based electric drive system supported by a smaller battery to provide quick and short power needs. This report will refer to this fuel-technology as ‘fuel cell’.

²⁵ O’Dell, J., “Nikola to Start Fuel Cell Truck Field Tests in Late 2018, Names Fuel Cell Suppliers,” Trucks.com, November 9, 2017, <https://www.trucks.com/2017/11/09/nikola-fuel-cell-truck-field-test-2018/>.

2018 Feasibility Assessment for Drayage Trucks –
Section 5: Assessment of Commercial Availability

cell trucks. Nikola reports that it has raised at least \$110 million in financing, and “intends to secure an additional \$500 to \$750 million from strategic and institutional investors in 2019.” Nikola plans to build approximately 5,000 Class 8 trucks beginning in 2021, using Fitzgerald Glider Kits (most likely based on Peterbilt, Kenworth, Freightliner or Western Star models). Nikola, which has retracted its initial requirement that pre-orders must include a \$1,500 deposit, claims that it has received 9,000 online orders for sleeper and day cab Class 8 trucks²⁶. Reportedly, Nikola has scheduled actual fleet field tests on prototype trucks for late

“Pre-Commercial” vs. “Early Commercial”

Per CARB’s use* of these terms, “early commercial” refers to emerging-technology Class 8 trucks that are relatively new to the market, but “have been demonstrated, are certified by CARB, come with a warranty, and are purchased or leased by the end user.” Typically, these are sold in small numbers and have not yet been commonly deployed in drayage service at the Ports. “Pre-commercial” trucks do not yet meet the above tests, and are essentially “focused on first-time demonstrations of advanced technologies in new applications.” A common element is that pre-commercial and early commercial Class 8 trucks require further demonstration in drayage service, to enable OEMs and end users to corroborate overall feasibility.

*See https://www.arb.ca.gov/msprog/aqip/fundplan/proposed_fy16-17_fundingplan_appb.pdf.

2018, and actual production will begin in 2021.²⁷ It appears that several major fleets have made pre-orders for trucks powered by Nikola’s fuel cell technology, including Anheuser-Busch, which has pre-ordered “up to 800” Class 8 day cab tractors.²⁸ Notably, 1) these trucks will not be used in port drayage, and 2) actual production is not scheduled for approximately three years.

5.6. Advancing Commercial Availability: Essential Role of Truck Demonstrations

Over the next few years, early commercial and pre-commercial demonstrations will play an essential role in expediting sustainable commercialization and wide deployment of ZE and NZE drayage trucks. Demonstrations are the key to enable OEMs and their customers to gain real-world operational experience in the rigorous duty cycles that typify San Pedro Bay drayage. As stated by the President and CEO of the world’s largest truck manufacturer (Daimler), “our customers want answers” well before they heavily invest in new truck technologies and peripheral requirements like fueling infrastructure. Before Daimler commercializes battery-electric Class 8 “e-Cascadia” tractors (the 2021 timeframe), the company and its customers both need to better understand key parameters like range, battery life, truck residual value, and total cost of ownership.²⁹

Fortunately, this process is well underway. As of mid-2018, there are at least 20 different major projects (recently completed, underway, or soon to start) focused on testing ZE and/or NZE Class 8 truck platforms in drayage duty at the San Pedro Bay Ports. These demonstration projects involve nearly all of the major existing Class 8 truck OEMs, as well as several start-up OEMs and technology providers.

²⁶ Gilroy, R., Transport Topics, “Nikola Eliminates Truck Deposits, Expands Initial Fueling Network.” 10 April 2018. <https://www.ttnews.com/articles/nikola-eliminates-truck-deposits-expands-initial-fueling-network>

²⁷ Ibid

²⁸ “Nikola Awards Nel Hydrogen Contract to Support 30 Fueling Stations,” Transport Topics, June 29, 2018, <https://www.ttnews.com/articles/nikola-awards-nel-hydrogen-contract-support-30-fueling-stations>

²⁹ [Trucking Info.com](https://www.truckinginfo.com), “Daimler Deals with Booming Market, Preps Electric Trucks,” October 29, 2018, <https://www.truckinginfo.com>.

**2018 Feasibility Assessment for Drayage Trucks –
Section 5: Assessment of Commercial Availability**

Approximately 120 individual drayage trucks are now being (or will soon be) demonstrated in and around the San Pedro Bay Ports. These test tractors roughly break-out as follows, according to their ZE or NZE architectures:

- 65 ZE battery-electric
- 16 ZE fuel cell
- 12 NZE natural gas ICE / hybrid electric
- 20 NZE natural gas ICE
- 7 NZE diesel ICE / hybrid electric

It is important to note that many of the newest, most-relevant projects are either just beginning to deploy demonstration Class 8 tractors, or will not deploy them until 2019. Figure 5 summarizes project timelines; the start and end dates refer to each project’s full schedule (award, set-up, demonstration, and close out). Some of these demonstrations have been delayed in getting started. The reality is that few (if any) key demonstrations will yield significant operational data until well into 2019, or possibly 2020. Until multiple units have been successfully demonstrated for a given fuel-technology platform -- and yielded sufficient data and “lessons learned” -- it will be premature to conclude that the five key parameters for determining overall feasibility have been fully achieved.

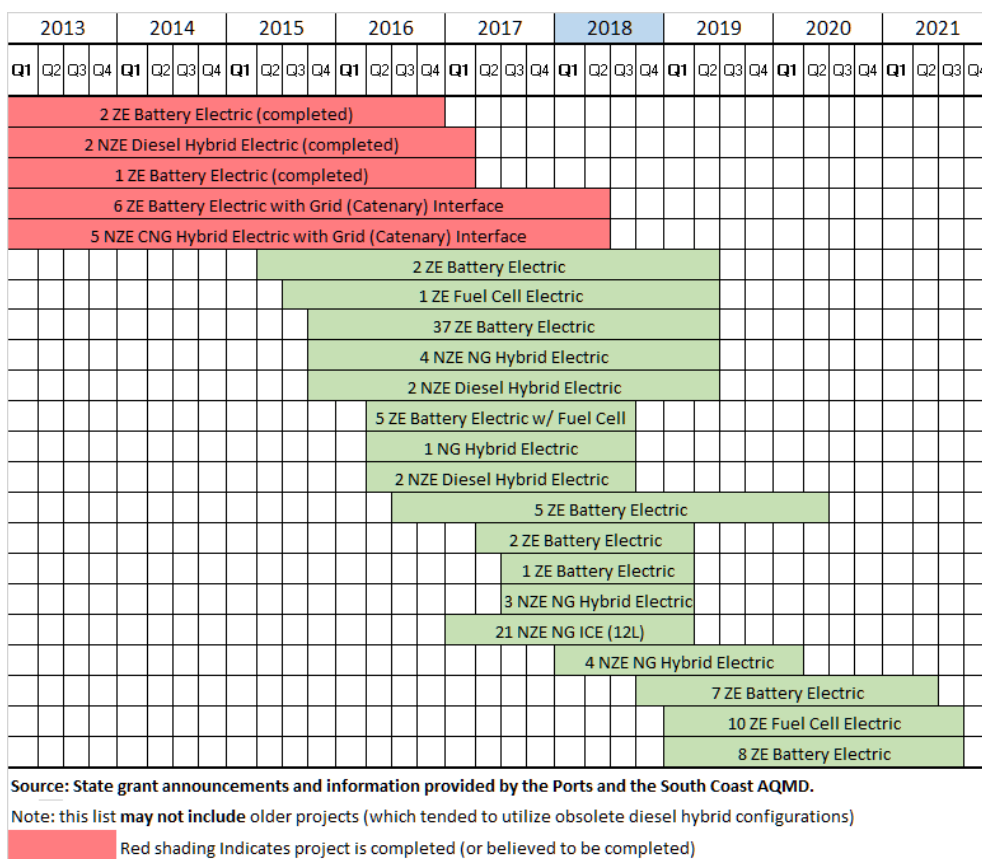

Figure 5. Type and timeline of ZE and NZE drayage truck demonstrations focused on the San Pedro Bay Ports.

5.6.1. Natural Gas Drayage Truck Demonstrations

Natural gas ICE technology is the most-advanced Class 8 ZE or NZE truck platform, in terms of both technological and commercial maturity. As of mid-2018, all six major OEMs commercially offer Class 8 NZE natural gas tractors in eight different models. This includes both compressed natural gas (CNG) and liquefied natural gas (LNG) fuel systems. Notwithstanding the major progress, even this most-advanced of the NZE platforms has not yet been

2018 Feasibility Assessment for Drayage Trucks –
Section 5: Assessment of Commercial Availability

widely evaluated by drayage fleets for Class 8 trucking in San Pedro Bay Ports drayage service. In particular, a demonstration involving 20 LNG drayage trucks with CWI’s 12-liter NZE natural gas engine (ISX12N) is expected to yield important operational data that are in the process of being collected, analyzed and reported. Peer-reviewed results and reports are expected in 2019.

Some preliminary reports have already emerged, primarily involving qualitative assessments. For example, Total Transportation Services Inc. (TTSI) conducted a demonstration under the Ports’ joint Technology Advancement Program (TAP) to test a drayage truck repowered with one of the early-deployment CWI 12-liter NZE natural gas engines. TTSI demonstrated the tractor in revenue service for approximately eight months, while accumulating about 19,000 miles. TTSI reported that this “alpha” test tractor powered by the new 12-liter NZE engine “performed very well in our operations.”³⁰ Further details about this and other testing for CWI’s NZE 12-liter natural gas engine platform are provided in Section 7 on Operational Feasibility.

In mid-2018, a new project was initiated to demonstrate 22 Class 8 drayage trucks powered by the ISX12N engine. These are being deployed by TTSI and five other harbor trucking firms under a pilot program co-funded by SCAQMD, CEC, the Ports, and other entities. To complement the major reductions of criteria pollutants (e.g., at least a 90 percent NOx reduction), all of the trucks are being fueled with renewable natural gas (RNG), which delivers major GHG reductions relative to baseline diesel or fossil natural gas trucks.³¹ Results from larger-scale, multi-unit demonstrations will be important to help fleets like TTSI gain full confidence in this fully commercialized NZE heavy-duty natural gas platform for drayage trucking.

5.6.2. Battery-Electric and Fuel Cell Drayage Truck Demonstrations

Of particular importance to the Ports are the numerous ZE-focused demonstrations that involve approximately 65 battery-electric tractors and 16 hydrogen fuel cell tractors. These two heavy-duty architectures are expected to play key roles in meeting the CAAP’s long-term plans for zero-emission drayage trucks. They are also foundations of heavy-duty mobile source control plans implemented by CARB and SCAQMD to attain National Ambient Air Quality Standards for ozone in the South Coast Air Basin.

Major existing and start-up heavy-duty OEMs are just beginning to demonstrate trucks powered by ZE platforms. Many of these ZE demonstrations feature BYD’s 8TT battery-electric tractor, which as described can be considered an “early commercial” product (see callout box below, and Section 6 on Technical Viability).

In addition, several important demonstrations are underway (or will soon start) that focus on pre-commercial Class 8 ZE drayage truck platforms, most of which are firmly backed by major existing OEMs. Table 7 summarizes key examples of Class 8 ZE truck platforms that are under development and limited demonstration by OEMs, including the previously mentioned Tesla Semi battery-electric platform and Nikola’s fuel cell platforms.

³⁰ Total Transportation Systems, Inc., “TAP Demonstration Final Report,” May 14, 2018, <http://www.cleanairactionplan.org/documents/hlt-demonstration-final-report-5-14-18.pdf/>

³¹ According to CARB’s Low Carbon Fuel Standard (LCFS) “Data Dashboard” (<https://www.arb.ca.gov/fuels/lcfs/dashboard/dashboard.htm>, dated 11/29/18), the volume-weighted carbon intensity value of RNG (CNG version) in the California LCFS is currently approximately 44 gCO₂e/MJ, or about 54 percent lower than the “2017 CI Standard.” This CI comparison includes the Energy Economy Ratio (EER) adjustment (efficiency penalty) for spark-ignition natural gas engines, compared to compression-ignition diesel engines. Some pathways for “bio CNG” (RNG) that are being used for California heavy-duty NGVs offer CI values as low as -250 to -300, which means they are “negative carbon” fuels.

2018 Feasibility Assessment for Drayage Trucks –
Section 5: Assessment of Commercial Availability

Table 7: OEM involvement in pre-commercial demonstrations of ZE Class 8 trucks in drayage

| Class 8 Truck Make | Model | ZE Battery-Electric | ZE Fuel Cell | Estimated Range |
|--|--------------------|---------------------|--------------|-----------------|
| Freightliner (Daimler) | eCascadia | ✓ | | 250 |
| Kenworth³² | ZECT T680 | | ✓ | 150 |
| Nikola Motors Co. | Nikola One and Two | | ✓ | 500 to 1,000 |
| Peterbilt | Model 579 | ✓ | | 150 |
| Tesla, Inc. | Semi | ✓ | | 300 to 500 |
| Thor³³ | ET-One | ✓ | | 300 |
| Toyota³⁴ (Portal) | TBD by OEM | | ✓ | 300+ |
| TransPower³⁵ | ElecTruck | ✓ | | 70 to 100 |
| General source, including range: OEM websites and publicly available literature | | | | |

The following further describes some key pre-commercial demonstration programs that are specifically focused on San Pedro Bay Ports drayage applications:

- In mid-2018, Daimler Trucks North America (DTNA) and SCAQMD announced a \$31.3 million heavy-duty electric truck project. By April 2019, 20 Freightliner electric trucks will be in operation, including seven Class-8 e-Cascadia model tractors that will specifically be demonstrated in drayage service. As part of the project scope, DC fast chargers will be installed at the identified fleet locations. DTNA is also exploring the feasibility and economics of pairing these charger stalls with energy storage systems, to reduce energy costs and demonstrate grid resiliency benefits. The project is expected to help provide DTNA – North America’s largest OEM for heavy-duty trucks – with essential real-world operational data on its proof-of-concept Class 8 electric truck technology. This is a vitally important step to prepare for commercialization.³⁶
- Under a \$44 million pilot project also funded by CARB under California’s Zero-Emission and Near Zero-Emission Freight Facilities (ZANZEFF) program, SCAQMD and Volvo will demonstrate 23 Volvo battery-electric Class 8 trucks using DC fast-charge technology at third-party logistics firm NFI. Many of these will

³² Kenworth’s ZECT platform currently uses a “range-extending” fuel cell to support a battery-electric architecture with a plug-in feature. It is unclear if this specific architecture is on Kenworth’s path to commercialization. Kenworth is also working with Toyota to demonstrate a different fuel cell architecture, under California “ZANZEFF funding (see text and other tables).

³³ Thor is a startup heavy-duty truck OEM “about two years old” that describes itself as a “transportation lab making electric commercial vehicle fleets a reality” (<https://www.thortrucks.com/>). Regarding its ET-One Class 8 truck, Thor’s website notes that “limited demonstrations are now available in the U.S.” Thor and its ET-One electric truck are not yet considered to be sufficiently developed to warrant further review in this 2018 Assessment. However, that could change in subsequent assessments.

³⁴ Toyota is primarily a light-duty car and truck OEM. It does not appear to have plans to build and sell Class 8 fuel cell trucks. Toyota appears most likely to sell fuel cell drivetrains to one or more existing Class 8 truck OEMs. However, these dynamics could change.

³⁵ TransPower is more of a “technology provider” for ZE and NZE powertrains used in heavy-duty trucks than it is an OEM of heavy-duty trucks. Specifically, TransPower “supplies integrated drive systems, full electric truck solutions and energy-storage subsystems to major manufacturers of trucks, school buses, refuse vehicles and terminal tractors.” TransPower is working directly with one or more Class 8 truck OEMs, and it has entered into a strategic partnership with Meritor, Inc. to build and commercialize heavy-duty electric drive technologies. Activities by both TransPower and Meritor to work with heavy-duty truck OEMs are further described in this Assessment.

³⁶ Neandross, E., “California Leading in Clean Freight Projects”, Advanced Clean Transportation News, September 20, 2018, <https://www.act-news.com/news/ca-zero-emission-freight-projects/>.

2018 Feasibility Assessment for Drayage Trucks –
Section 5: Assessment of Commercial Availability

specifically be demonstrated in drayage service. According to NFI, Volvo’s ZE Class 8 tractors will incorporate advanced smart technologies to monitor truck performance and maximize vehicle uptime.”³⁷

- Since mid-2017, Toyota has been testing a prototype Class 8 tractor powered by hydrogen fuel cell technology, in drayage service. Toyota is using the same proton exchange member fuel cell (PEMFC) technology that it has already commercially deployed in its Mirai fuel cell passenger cars. The Kenworth Class 8 tractor used by Toyota in the project incorporates two Mirai PEMFC stacks in parallel (totaling about 230 kW of peak power output), hybridized with a small battery pack (about 12 kWhr). Under the initial Project Portal effort, Toyota has been testing its first prototype PEMFC truck in local drayage service, from Toyota’s Port of Long Beach facility. In mid-2018, Toyota launched a second “Beta” model, which reportedly offers longer range (increased from 200 to 300 miles), and other improvements.³⁸ Notably, Toyota’s apparent ultimate plan is to sell this heavy-duty PEMFC drive system to Class 8 truck OEMs (rather than to become a Class 8 OEM itself).
- In a major new program related to Toyota’s Portal Project, CARB has awarded \$41 million to the Port of Los Angeles to develop and demonstrate 10 ZE Class 8 fuel cell tractors using Kenworth’s T680 platform. This award is also part of California’s ZANZEFF program. Under a collaboration between Kenworth and Toyota, these fuel cell drayage trucks will be built specifically to move cargo from POLA terminals to local distribution centers, and “ultimately to inland locations such as Riverside County, the Port of Hueneme, and eventually to Merced.” The 10 fuel cell tractors will be operated by Toyota Logistics Services, United Parcel Services, Total Transportation Services Inc., and Southern Counties Express. In a second phase of the project, two new “large capacity heavy-duty hydrogen stations” will be developed by Shell to serve these fuel cell trucks (one in Wilmington, one in Ontario).³⁹ ZANZEFF projects must be completed by April 2021.
- Also under the ZANZEFF solicitation, the Port of Long Beach has been co-awarded major funds for Phase 1 of the “START” (Sustainable Terminals Accelerating Regional Transformation) project. This project will demonstrate a wide array of ZE trucks and equipment, including 15 Class 8 battery-electric Peterbilt trucks that will be tested in drayage service (five at the Port of Long Beach and 10 at the Port of Oakland).

The number, scope and OEM involvement of these demonstrations are testaments to the important recent progress that’s been made to advance commercialization of Class 8 ZE and NZE tractors for drayage service at the San Pedro Bay Ports. However, as the timeline suggests, existing and potential end users (San Pedro Bay Ports drayage companies) are just beginning to obtain sufficient real-world experience and operational data on Class 8 tractors using ZE or NZE platforms. As the various trucking fleets receive and deploy their demonstration units towards late 2018 and into 2019, drayage operators will be better able to assess the overall feasibility of these emerging types of Class 8 trucks.

³⁷Angell, M., “NFI Industries will test Volvo’s all-electric trucks next year in Southern California,” FreightWaves, October 8, 2018, <https://www.freightwaves.com/news/nfi-industries-volvo-electric-truck>.

³⁸Everts, E., “Toyota introduces second hydrogen fuel-cell powered semi working in Los Angeles,” Green Car Reports, July 31, 2018, <http://www.evdriven.com/long-beach/los-angeles/?open-article-id=8649458&article-title=toyota-introduces-second-hydrogen-fuel-cell-powered-semi-working-in-los-angeles&blog-domain=greencarreports.com&blog-title=green-car-reports>.

³⁹Port of Los Angeles, “Port of Los Angeles Preliminary Awarded \$41 Million From California Air Resources Board to Launch Zero Emissions Hydrogen-Fuel-Cell-Electric Freight Project,” September 14, 2018, https://www.portoflosangeles.org/references/news_091418_carb_toyota.

5.6.3. Larger-Scale Next-Generation Demonstrations

Notwithstanding the critical importance of these already-awarded demonstration programs, the Ports recognize the need to rapidly move into larger-scale pre-commercial and early commercial deployments involving ZE and NZE platforms. In tandem, there is a strong need to help fleets understand and test corresponding types of fueling infrastructure. Consequently, in October 2018 the two Ports formed an ad hoc Large-Scale Zero-Emission Truck Demonstration Working Group.⁴⁰ The intent is to obtain important feedback from various stakeholders about the scope and logistics for potentially implementing several large-scale demonstrations of ZE drayage trucks. These new efforts are envisioned to build upon the numerous smaller-scale demonstrations that are now underway or planned to start in 2019.

Current demonstrations generally involve a few prototype ZE and/or NZE drayage trucks that are undergoing initial (alpha or beta) testing. For the new larger-scale demonstration program, the Ports envision that 50 to 100 ZE drayage trucks will be operated by LMCs in real-world service. Each truck architecture will already need to be 1) developed past the prototype stage, and 2) proven to meet basic requirements of LMCs for operation in San Pedro Bay Ports drayage service. The Ports seek strong involvement from interested LMCs, which will join with OEMs to plan and implement these demonstrations. In addition to the demonstration trucks, OEMs will provide essential systems and services during the demonstration (maintenance, warranty, training and replacement parts, etc.).

To initiate this process, the two Ports anticipate releasing a Request for Proposals in early 2019, contingent on securing funding. It will call for multiple demonstrations, each featuring at least 10 tractors of the same ZE architecture. Architectures will likely be required to have proven capability to provide a to-be-determined minimum number of zero-emission miles, even if there is a combustion component. For example, this could be achieved with a plug-in electric platform that has been hybridized in parallel with a near-zero-emission natural gas engine. On a preliminary basis, the Ports envision that multiple large-scale demonstrations would be planned and initiated before 2021, although the overall schedule will be dependent on funding availability and other factors. They will use these demonstrations to help LMCs further evaluate any remaining challenges associated with integrating large numbers of ZE trucks into the full operations of their drayage fleets, including infrastructure-related complexities and choices (e.g., on- versus off- site fueling or recharging).

5.7. OEM Expectations for Commercial Availability by 2021

As of late-2018, the major existing OEMs – as well as the start-up and emerging OEMs – appear to be increasing and expediting their efforts to commercialize ZE and/or NZE Class 8 trucks; this includes focus on port drayage applications. To better understand their commercialization plans and intentions within the timeframe of this Assessment, the Class 8 truck OEMs (existing and emerging) were queried about the types of ZE and NZE architectures they expect to sell by 2021. Table 8 summarizes the inputs received from eight responding OEMs.

Table 8: Summary of responses from surveyed Class 8 OEMs about expected 2021 commercial Class 8 trucks

| Truck Configuration | Baseline Diesel ICE* | ZE Battery-Electric | ZE Fuel Cell | NZE Natural Gas (ICE) | NZE Hybrid Electric** |
|---|----------------------|----------------------|----------------------|-----------------------|-----------------------|
| Day Cab | 8 Models (2 OEMs) | 9 Models (5 OEMs) | 1 Model (1 OEM) | 8 Models (3 OEMs) | 2 Models (1 OEMs) |
| Sleeper Cab | 7 Models (2 OEMs) | 3 Models (2 OEMs) | 0 Models (0 OEMs) | 1 Model (1 OEMs) | 0 Models (0 OEMs) |
| Source: GNA survey of major existing and emerging Class 8 OEMs, July 2018. | | | | | |
| *Baseline diesel may or may not be at NZE status by 2021 (i.e., certified to a CARB OLNS; see text for discussion). | | | | | |
| ** Electric drive hybridized with an ICE (any fuel); may or may not include plug-in capability. | | | | | |

⁴⁰ Information in this section was conveyed by Port representatives during a conference call to drayage trucking stakeholders on October 16, 2018.

2018 Feasibility Assessment for Drayage Trucks –
Section 5: Assessment of Commercial Availability

There were notable changes in these 2021 plans relative to what the same OEMs reported for their 2018 commercial offerings (refer back to Table 5). These can be summarized as follows:

- **Baseline** Class 8 diesel ICE trucks⁴¹: OEMs offering / number of models will generally diminish
- **ZE** battery-electric Class 8 trucks: OEMs offering / number of models will significantly expand
- **ZE** fuel cell Class 8 trucks: OEMs offering / number of models will not significantly change
- **NZE** natural gas Class 8 trucks: OEMs offering / number of models will slightly diminish⁴²
- **NZE** hybrid electric (ICE/grid-electric) truck: One OEM will offer two models (first commercial entries)

Of particular importance is that some major Class 8 truck OEMs appear on track to offer ZE battery-electric Class 8 trucks by 2021, or soon after. This is generally corroborated by public announcements now being made by the same OEMs. Examples of announcements by major Class 8 truck OEMs regarding ZE battery-electric truck offerings in the 2021 timeframe (and beyond) include the following:

- Daimler Trucks reportedly plans to enter into full-scale production of its Class 8 battery-electric e-Cascadia truck by 2021. Daimler will specifically target its e-Cascadia model for local and regional trucking applications including drayage.⁴³ Such shorter-range applications are conducive to the current energy density (range) limitations of battery technology (see Section 7 on Operational Feasibility).
- Navistar has announced its intention to commercialize and sell large numbers of battery-electric Class 8 trucks by 2025, although Navistar has not yet provided vehicle specifications.⁴⁴
- Volvo intends to sell battery-electric heavy-duty trucks in North America after an initial (2019) launch in Europe.⁴⁵ Prior to a corresponding commercial launch for North America, Volvo will conduct a major demonstration of Class 8 battery-electric trucks at the San Pedro Bay Ports starting in 2019 (refer back to Section 5.6). Thus, it appears that Volvo's potential North American commercial launch of Class 8 battery-electric trucks will occur in the 2020-2022 timeframe. (**Note:** at the time this report was being published, December 2018, Volvo announced its intention to commercialize a battery-electric version of its VNR Class 8 truck in 2020.)

When combined with major OEM activities involving fuel cell architectures, it appears that most (if not all) of the major OEMs are developing Class 8 tractors with ZE architectures. Battery-electric tractors are on a faster track than fuel cell tractors. These various OEMs are likely to commercialize ZE tractors on a timeline commensurate with commercial maturity and a good business case. While progress has clearly accelerated, the existing heavy-

⁴¹As noted in the table, "baseline diesel" may or may not achieve NZE status by 2021 (i.e., certified to a CARB OLNS; see text for further discussion).

⁴² Cummins Westport notes that they have no indication from their current OEM customers that any would cease offering the ISX12N as an option by 2021. (Cummins Westport comments on draft Feasibility Assessment, January 31, 2019)

⁴³ Hirsch, J., "Daimler Unveils Electric Freightliner Cascadia," Trucks.com, June 6, 2018, <https://www.trucks.com/2018/06/06/daimler-unveils-electric-freightliner-cascadia/>

⁴⁴ Hurt, E., "Navistar CEO to Tesla: We'll Have More Electric Trucks Than You," Trucks.com, January 2, 2018, <https://www.trucks.com/2018/01/02/navistar-versus-tesla-electric-trucks/>

⁴⁵ O'Dell, J., "Volvo Will Sell Electric Trucks in Europe Next Year, North America to Follow," Trucks.com, <https://www.trucks.com/2018/01/23/volvo-electric-trucks-europe-north-america/>

2018 Feasibility Assessment for Drayage Trucks –
Section 5: Assessment of Commercial Availability

duty truck OEMs tend to be cautious about expectations for the 2021 timeframe. For example, one major Class 8 OEM stated:

“2021 is a bit too soon for us to offer a thoroughly-tested commercial product that is capable of zero emissions. We hope to have products to offer in limited production quantities in the 2023-2024 timeframe. We are concerned, however, that the payback to the end user for ZE trucks will be too long for widespread adoption without significant incentives. Development of such trucks is quite expensive, and we as an OEM are concerned about whether the size of the market will justify the cost of development of these products.”⁴⁶

5.8. Summary of Findings for Commercial Availability

5.8.1. Status in 2018 for Leading Fuel-Technology Platforms

Table 9 summarizes the basic findings and conclusions discussed in this section on Commercial Availability. The first two columns repeat specific criteria and base considerations. The final five columns provide ratings about the relative degree to which the five core ZE and NZE drayage fuel-technology platforms appear to currently meet these basic considerations, or at least show measurable progress towards meeting them by approximately 2021.

The commercialization landscape for these products is dynamic, and subject to unforeseen rapid change. For this reason, the Ports will update the 2018 Feasibility Assessment every three years, or sooner if warranted by major new developments for technological and/or commercial maturity.

⁴⁶Comment by a major Class 8 truck OEM, submitted via the OEM survey completed in mid-2018.

2018 Feasibility Assessment for Drayage Trucks –
Section 5: Assessment of Commercial Availability

Table 9. Summary of ratings by key criteria: 2018 Commercial Availability

| Commercialization Criteria | Base Considerations | Assessment of Criteria Achievement in 2018 by Leading ZE and NZE Fuel-Technology Drayage Truck Platforms | | | | |
|--|---|--|--------------|---------------------|------------|----------------|
| | | ZE Battery-Electric | ZE Fuel Cell | NZE Hybrid Electric | NZE NG ICE | NZE Diesel ICE |
| Production and Sales with Major OEM Involvement | Production and full certification by either a major Class 8 truck OEM, or by a proven technology provider that has partnered with the major OEM. | | | | | |
| Proven Network / Capabilities for Sales, Support and Warranty | Demonstrated existing (or near-term planned) network of sufficient dealerships to sell, service, warranty and provide parts for all commercially deployed drayage trucks. | | | | | |
| Sufficient Means and Timeline for Production | Demonstrated capability to manufacture sufficient numbers of Class 8 trucks (suitable for drayage) within timeline to meet existing or expected demand. | | | | | |
| Existence of Current and/or Near-Term Equipment Orders | Demonstrated backlog of orders, or credible expression of interest from prospective customers to submit near-term orders. | | | | | |
| Legend: Commercial Availability (2018) | | | | | | |
| Source of Ratings: based on OEM survey responses, OEM product information, various government sources, and consultant's industry knowledge. | | | | | | |

5.8.2. Discussion and Implications to Overall Feasibility

Collectively, the above estimated levels of achievement provide an objective snapshot about the commercialization status of Class 8 trucks powered by five core fuel-technology platforms. Discussion follows about 1) the specific rationale used to derive these ratings for each of the fuel-technology platforms; and 2) the overall implications to this 2018 Drayage Truck Feasibility Assessment.

ZE Battery-Electric – As described, start-up OEM BYD is commercially selling a Class 8 battery-electric tractor in California today. BYD and other OEMs have made major progress to advance heavy-duty battery-electric truck commercial maturity and technical viability. Notably, none of the key criteria and base requirements that collectively define commercial availability are fully met yet. The net result is that battery-electric drayage trucks are in a stage of limited, early commercialization (one OEM, one model that is not yet fully proven for all parameters). However, one or more mainstream Class 8 OEMs appear ready to enter this market by 2021. Battery-electric drayage trucks currently offer driving ranges that fall well short of baseline diesel ICE tractors, or even natural gas ICE tractors. Consequently, use of these tractors for the next several years will likely be restricted to short-range drayage applications. (This very important parameter is further discussed in Section 6 on Technical Viability and Section 7 on Operational Feasibility.) Notwithstanding range-related use limitations, it appears that Class 8 battery-electric tractors may be able to (at least marginally) meet key criteria for commercial availability within the timeframe of this Assessment, especially given the stated intent of at least one major OEM to enter the market by 2021.

2018 Feasibility Assessment for Drayage Trucks –
Section 5: Assessment of Commercial Availability

Class 8 electric drive tractors that are directly powered by the electricity grid (i.e., via a catenary system) have also been developed and demonstrated in drayage duty at the San Pedro Bay Ports, but only in a very limited capacity. At this time, there is no clear commercialization pathway or timeline for drayage trucks in California using this type of fuel-technology platform. Therefore, no further evaluation is warranted in this 2018 Drayage Truck Feasibility Assessment. However, it is likely that future Assessments will need to revisit such technology for evolving commercialization potential.

ZE Fuel Cell – As previously described, startup OEM Nikola Motors has received hundreds of preliminary procurement orders from major Class 8 trucking fleets for its two different hydrogen fuel cell tractor models. Notably, Nikola has not yet provided specifics about production dates, costs, or final specifications, although it has indicated mass production will be well underway by 2025. The reality is that Class 8 tractors incorporating hydrogen fuel cell technology are just beginning to be developed and demonstrated in drayage service at the Ports. In addition to Nikola’s efforts, Kenworth (in conjunction with Toyota) is working to develop and eventually commercialize Class 8 trucks powered by hydrogen fuel cell technology under two major demonstration programs just getting underway.

So far, there does not seem to be consensus among the OEM participants (and/or their technology-providing partners) about the optimal architecture for Class 8 fuel cell trucks. For example, Toyota appears to be independently working on a fuel cell-dominant architecture that will utilize a relatively small battery pack for peak power and regenerative braking. Kenworth and Nikola appear to be focused on battery-dominant architectures that use a relatively small fuel cell stack to supplement battery power and/or extend driving range. These architectures are likely to continue evolving as prototype testing and demonstration efforts move forward.

At this time, it appears that no OEM (major or startup) is likely to achieve true commercialization (as defined in this Assessment) for a Class 8 fuel cell tractor model until well past 2021, although the technology and commercialization landscapes could change quickly. First, strong progress is being made to build, test and eventually mass-manufacture fuel cell buses. Equally important, HDV end user fleets (transit properties, primarily) are gaining important experience building out hydrogen fueling stations (see for example the California Fuel Cell Partnership’s webpage titled “Stations,” at <https://cafcp.org/stations>). This progress clearly has potential for technology transfer into Class 8 trucking applications. Second, Toyota’s decision to design and test heavy-duty hydrogen fuel cell drivetrains for Class 8 drayage trucks could significantly accelerate progress to commercialize drayage-suitable trucks with this ZE architecture. Toyota has stated that heavy-duty hydrogen fuel cells are the “powertrain of the future” for on-road goods movement.⁴⁷ Toyota is a leading light-duty OEM that already has extensive experience commercializing hydrogen fuel cell systems for transportation, and it owns medium-duty OEM Hino. Additionally, Toyota is partnering with Class 8 OEM Kenworth to develop and demonstrate 10 fuel cell drayage trucks.

Given all this important OEM-backed activity, hydrogen fuel cell systems have been further evaluated in the next section (Technical Viability), which has been used as the second parameter used to screen for overall feasibility.

Perhaps more than any other ZE or NZE fuel-technology platform, the rate-determining step for commercializing hydrogen fuel cell trucks appears to be as much (or more) fuel related than vehicle related. Significant cost and logistical challenges will need to be overcome before LMCs are likely to gain affordable, convenient access to hydrogen fuel. This is further discussed in Section 8 on Infrastructure Availability.

⁴⁷ Kenworth press release, September 14, 2018, <https://www.kenworth.com/news/news-releases/2018/september/pola/>.

2018 Feasibility Assessment for Drayage Trucks –
Section 5: Assessment of Commercial Availability

NZE Hybrid Electric - Class 8 tractors with hybrid-electric drive systems have been built and demonstrated over the last decade. These efforts have been led by mainstream OEMs as well as technology providers (most notably, TransPower and US Hybrid). While some general activity continues today – e.g., some commercial penetration of hybrid-electric drivetrains into transit bus markets – at this time there is no clear commercialization pathway or timeline for drayage trucks using this type of fuel-technology platform. Therefore, no further evaluation is warranted in this 2018 Drayage Truck Feasibility Assessment. However, it is certainly possible that future Assessments will need to revisit such technology for evolving commercialization potential.

NZE Natural Gas ICE - Among the five core fuel-technology platforms, drayage trucks powered by natural gas ICE technology are farthest along the path of commercial availability. NZE natural gas drayage trucks have already reached the “fully achieved” status according to the key criteria and considerations that were originally outlined in the Ports’ joint Framework document. Specifically, today’s Class 8 natural gas trucks are 1) mass-produced and sold by at least four mainstream Class 8 truck OEMs; 2) available in approximately 12 different day cab and sleeper truck models; 3) powered by CWI’s 12-liter ISX12G engine certified by CARB to the lowest-tier OLS; 4) capable of providing diesel-equivalent performance and range in all three general types of drayage trucking, and 5) fully supported by OEMs for the key provisions identified in the table (warranty, parts, maintenance, training, etc.). Notwithstanding this high degree of achievement, it will be very important for Class 8 NZE natural gas drayage trucks to meet LMC expectations during the various demonstrations (see Section 6 on Technical Viability and Section 7 on Operational Feasibility). Additionally, a market risk factor for this particular fuel-technology platform is that currently, only one engine manufacturer (CWI) is selling heavy-duty natural gas engines suitable for Class 8 heavy-duty trucks used in drayage.

NZE Diesel ICE – Unless and until at least one heavy-duty engine OEM successfully certifies a drayage-suitable heavy-duty diesel engine to CARB’s OLS of 0.02 g/bhp-hr (or whichever NZE emissions level is ultimately adopted by CARB), this fuel-technology platform cannot be considered to be commercially available. See Section 6 on Technical Viability.

6. Assessment of Technical Viability

6.1. Background: Criteria and Methodology

The federal government, manufacturers and researchers often assign Technology Readiness Level (TRL) ratings as a means to help track, assess and describe the technological maturity of emerging products as they progress towards commercialization. Typically, these scales range from TRL 1 (just emerging as a basic principle) to TRL 9 (now fully commercial). Such a system can be very useful for tracking progress with new types of heavy-duty transportation technologies. For this 2018 Drayage Truck Feasibility Assessment, snapshot TRL ratings have been assigned to emerging ZE and NZE platforms. This provides an objective, standardized means to gauge and compare technical readiness for broad commercial deployment at the San Pedro Bay Ports over the next several years.

The U.S. Department of Energy (DOE) has published a guidebook⁴⁸ designed to help government researchers conduct technology readiness assessments. DOE's guide includes a standardized TRL scale that is useful for tracking and assessing progress for HDV prototypes that are being developed, demonstrated and/or commercialized under government funding. DOE has established definitions for each of nine TRLs, as summarized in Table 10 below; this is a condensed version of DOE's TRLs in the referenced guidebook.

⁴⁸ U.S. Department of Energy, "Technology Readiness Assessment Guide", September 15, 2011, <https://www.directives.doe.gov/directives-documents/400-series/0413.3-EGuide-04a/@@images/file>.

2018 Feasibility Assessment for Drayage Trucks –
Section 6: Assessment of Technical Viability

Table 10: Definitions for Technology Readiness Levels (TRLs) adapted from U.S. DOE

| Relative Stage of Development | Corresponding TRL # | DOE's TRL Definition / Description (condensed / abbreviated) |
|--------------------------------------|---------------------|--|
| Systems Operations | TRL 9 | Actual system in its final form and operated under full range of operating mission conditions . Examples include using the actual system with the full range of wastes in hot operations. |
| Systems Conditioning | TRL 8 | Actual system completed and qualified through test and demonstration . The technology has been proven to work in its final form and under expected conditions. In almost all cases, this TRL represents the end of true system development . |
| | TRL 7 | Full-scale, similar prototype system demonstrated in relevant environment . Represents a major step up from TRL 6, requiring demonstration of an actual system prototype in a relevant environment. |
| Technology Demonstration | TRL 6 | Engineering/pilot-scale , similar (prototypical) system validation in relevant environment ; represents a major step up from TRL 5 |
| Technology Development | TRL 5 | Laboratory scale , similar system validation in relevant environment : basic technological components are integrated so that system configuration is similar to (matches) final application in almost all respects. |
| | TRL 4 | Component and/or system validation in laboratory environment : basic technological components are integrated to establish that pieces will work together; this is relatively "low fidelity" compared with the eventual system. |
| Research to Prove Feasibility | TRL 3 | These TRLs range from Initiation of active research & development (TRL 3) down to Basic principles observed and reported (TRL 1) |
| | TRL 2 | |
| Basic Research | TRL 1 | |

Source: adapted from U.S. Doe, "Technology Readiness Assessment Guide," Table 1: Technology Readiness Levels, September 2011.

6.2. Estimated 2018 TRL Ratings (with Prognosis for 2021)

DOE’s TRL system provides a straightforward, concise and defensible tool to compare the technological maturity of various emerging fuel-technology platforms that have the clearest potential for wide-scale application in drayage trucking over the next several years. Using DOE’s system, TRL ratings have been assigned for the five emerging ZE and NZE platforms discussed in this report, and educated prognoses have been made for how those TRL ratings are expected to change by 2021. These TRL ratings were derived by applying publicly available information (e.g., OEM technical specifications) and survey responses directly submitted by the OEMs.

The following summarizes the assigned 2018 TRL rating for each platform, and the corresponding prognosis for it to improve by 2021.

- **ZE** battery-electric drayage trucks are currently at **TRL 6 to 7** (early commercial demonstration and initial conditioning). This fuel-technology platform offers the benefits of electric drive (higher efficiency, regenerative braking, and others), but it also faces key challenges associated with battery cost, weight and

2018 Feasibility Assessment for Drayage Trucks –
Section 6: Assessment of Technical Viability

energy density. Class 8 battery-electric trucks suitable for drayage will most likely move up to **TRL 8 by 2021**, primarily because this platform is likely to benefit significantly from 1) major OEM and government support, and 2) ongoing successful adaptation of the technology in both transit bus and medium-duty trucking applications.

- **ZE** fuel cell drayage trucks are currently at **TRL 5 to 6** (technology development and demonstration). This fuel-technology platform shows good long-term promise for drayage applications. It offers a compelling combination of electric drive and combustion-free electrochemical conversion (zero emissions, high efficiency), while also utilizing a rapidly refillable hydrogen tank with potential to deliver diesel-equivalent driving range. However, fuel cell trucks also face significant challenges over the next several years; these are mostly associated with the costs and logistics of hydrogen fuel itself. Notably, Toyota’s apparent entry into the market for heavy-duty fuel cell drive systems could in itself be a significant accelerator for technological and commercial maturity. Additionally, fuel cell buses are making steady progress in California and worldwide; it is likely that this will help advance Class 8 truck applications. It is estimated that Class 8 fuel cell trucks suitable for drayage may move up to **TRL 7 by 2021**, but TRL 8 (initial commercialization) seems unlikely for this tough application before the 2025 timeframe.
- **NZE** plug-in hybrid drayage trucks are also currently at **TRL 5 to 6** (technology development and demonstration). This fuel-technology platform provides the advantages of electric drive, but it does not provide zero emissions if fuel combustion is utilized (typically, this would be an ICE or turbine). However, plug-in hybrid architectures can offer an important advantage: “zero-emission mile” capability. This can be very attractive for shorter-haul drayage service conducted in and around disadvantaged communities near the San Pedro Bay Ports. The 2021 prognosis for this type of platform is generally uncertain. Currently, no heavy-duty OEMs are sending a clear and strong signal about commercialization. Provided that there is OEM commitment, Class 8 plug-in hybrid trucks suitable for drayage service may move up to **TRL 7 (or 8) by 2021**.
- **NZE** natural gas ICE drayage trucks are currently at **TRL 8** (commercial demonstration and final conditioning). This fuel-technology platform (using CWI’s 12-liter NZE engine) is very likely to move up to **TRL 9**. At least 22 trucks are currently undergoing real-world system conditioning in San Pedro Bay Ports’ drayage service. The general technology is robust and well proven, as evidenced by very strong commercial roll-outs by all of the mainstream heavy-duty truck OEMs.
- **NZE** diesel ICE drayage trucks are currently at **TRL 5** (technology development). To date, no heavy-duty diesel engine has been certified to CARB’s OLNS. However, promising research efforts are underway (e.g., at Southwest Research Institute). The basic goal is to achieve very low NOx emissions (preferably the lowest-tier 0.02 g/bhp-hr level already achieved by multiple heavy-duty NG engines), while also managing key tradeoffs (fuel efficiency/GHG emissions, cost, durability and reliability). Uniquely, Class 8 NZE diesel trucks could leapfrog from the current TRL 5 up to **TRL 8 or 9 by 2020** (i.e., equivalent to the current level for the NZE natural gas ICE platform). However, this will require at least one heavy-duty engine OEM to successfully certify a drayage-suitable heavy-duty diesel engine to CARB’s OLNS of 0.02 g/bhp-hr, or whichever NZE emissions level is ultimately adopted by CARB. It will also be necessary to successfully demonstrate that the engine (combined with its advanced emission control system) will be able to provide acceptable durability and reliability in drayage trucking operations at the San Pedro Bay Ports.

6.3. Comparison to CARB’s Most-Recent Technology Snapshot and TRL Ratings

In late 2015 and into 2016, CARB released a series of “Technology and Fuel Assessments” that evaluated the technical maturity of numerous leading ZE and NZE fuel-technology platforms for on-road HDVs. CARB’s 2015-2016 assessments included several reports specifically focused on on-road heavy-duty trucks, including Class 8 heavy-heavy duty trucks (HHDTs) used in drayage.⁴⁹ In September 2018, CARB staff prepared key updates about the technological maturity and commercial availability of ZE and NZE HDV platforms. Staff used these updates to help draft California’s Proposed Fiscal Year 2018-19 Funding Plan for Clean Transportation Incentives.⁵⁰ Staff noted that heavy-duty truck OEMs have been able to steadily advance emerging ZE and NZE technologies, for both technological readiness and commercial viability.

To provide a snapshot status (as of mid-2018), CARB staff assigned preliminary TRL ratings to the leading ZE and NZE platforms for various HDV applications, including drayage trucks. Using NASA’s TRL scale (which is similar to the U.S. DOE TRL scale previously described), CARB assigned average TRL ratings intended to “provide directional information” about where various ZE and NZE platform rank today.

Figure 6 roughly summarizes CARB’s snapshot TRL ratings and commercial maturity assessments for three key on-road HDV applications (drayage trucks plus delivery trucks and transit buses). The **green** bars summarize CARB’s assessment for the two leading **ZE** platforms: battery-electric (BE) and fuel cell (FC). The **blue** bars summarize CARB’s assessment for the two leading **NZE** platforms: low-NOx natural gas (NG) engines and plug-in hybrid electric (PHEV) technology. All drayage truck platforms are represented by the darkest bars, to distinguish from non-drayage delivery trucks and transit buses (faded bars). Where provided, arrows next to the bars summarize cases where CARB staff observed “directional changes in commercialization status” over the past year (approximately).⁵¹

⁴⁹ For the full range of CARB technology assessment reports relevant to Class trucks, see Draft Heavy-Duty Technology and Fuels Assessment: Overview (April 2015), Corrections to Draft Heavy-Duty Technology and Fuels Assessment: Overview (August 2016), Draft Technology Assessment: Medium- and Heavy-Duty Fuel Cell Electric Vehicles (November 2018), Draft Technology Assessment: Medium- and Heavy-Duty Battery-electric Trucks and Buses (October 2015), Draft Technology Assessment: Lower NOx Heavy-Duty Diesel Engines (September 2015), and Draft Technology Assessment: Low Emission Natural Gas and Other Alternative Fuel Heavy-Duty Engines (September 2015).

⁵⁰California Air Resources Board, “Proposed Fiscal Year 2018-19 Funding Plan for Clean Transportation Incentives for Low Carbon Transportation Investments and the Air Quality Improvement Program,” September 21, 2018, https://www.arb.ca.gov/msprog/agip/fundplan/proposed_1819_funding_plan.pdf.

⁵¹Ibid. See the section titled “Technology Status Updates” beginning on page D-5.

2018 Feasibility Assessment for Drayage Trucks –
Section 6: Assessment of Technical Viability

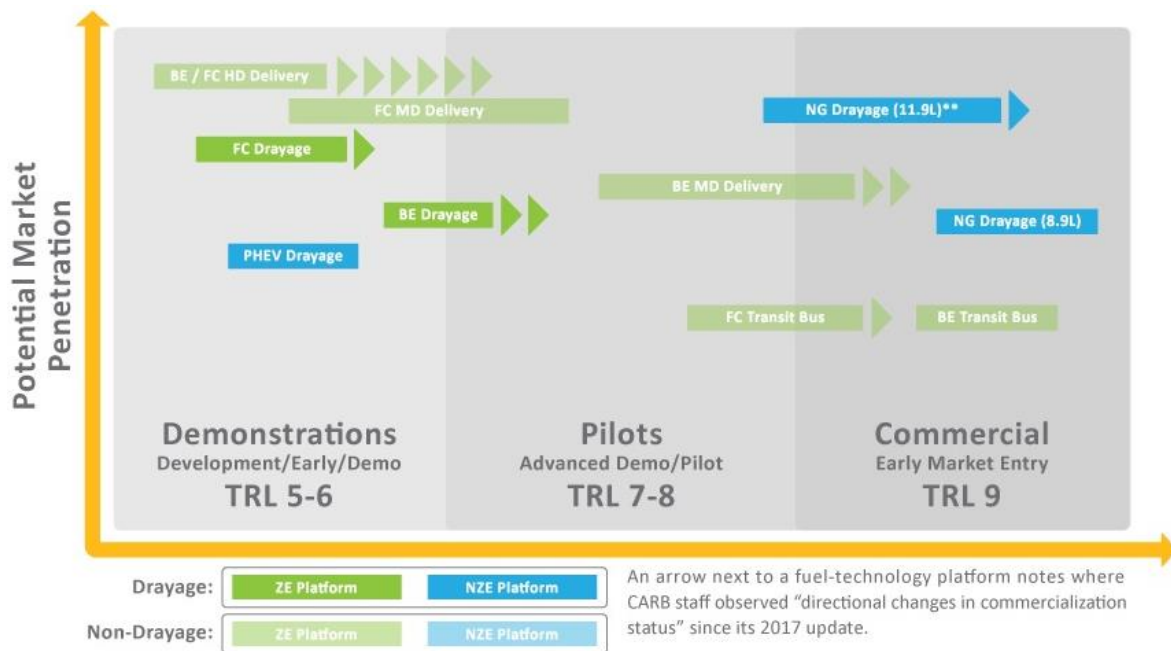

** Suitable for all drayage duty cycles including regional, as well as “some line haul trucking”

Sources:

Adapted from CARB Figures 3, 4, 5 and 6, in California Air Resources Board, “Proposed Fiscal Year 2018-19 Funding Plan for Clean Transportation Incentives for Low Carbon Transportation Investments and the Air Quality Improvement Program,” September 21, 2018, https://www.arb.ca.gov/msprog/aqip/fundplan/proposed_1819_funding_plan.pdf. Page D-5 to D-19.

Figure 6. Summary of CARB’s draft TRL ratings (NASA scale) for ZE and NZE HDV platforms

In conclusion, CARB’s 2018 TRL ratings (applying NASA’s scale) -- as well as their general assessment of commercial maturity -- are very similar to those presented in this 2018 Drayage Truck Feasibility Assessment (refer back to section 6.2). The following summarizes relevant findings that can be inferred from CARB’s TRL rating graphs, and the cited CARB report’s corresponding narrative:

- **ZE BE** drayage trucks are relatively new but advancing quickly; they are now transitioning from **TRL 6** (early stage demonstration) into **TRL 7** (Advanced Pilot Demonstration). BE drayage trucks are less technologically mature than BE transit buses (TRL 9) and BE medium-duty delivery trucks (~TRL 8), but they exhibit good “potential market penetration” in the future. Within a year, ZE BE drayage trucks will be “ready for larger pilot-scale deployment to maintain momentum and continue to push the technology toward commercialization.” Strong involvement by transit bus OEMs on battery-electric platforms will also help support technology advancements and supply chain buildouts for Class 8 trucking applications such as drayage.
- **ZE FC** drayage trucks are currently in the **TRL 5 to TRL 6** range; this early demonstration phase is measurably less mature (technologically and commercially) than BE drayage trucks. For all three types of HDV applications (drayage trucks, non-drayage delivery trucks, and transit buses), FC HDV platforms are less technologically advanced compared to their counterpart BE HDV platforms. On the other hand, FC HDVs show a higher “potential market penetration” than their BE counterparts. Presumably, CARB staff is recognizing here that FC platforms offer important range-related operational advantages over BE platforms. Specifically, FC HDVs can carry enough onboard hydrogen to enable driving ranges that approach those of HDVs powered by diesel or natural gas engines. Additionally, they can be refueled nearly as fast as diesel HDVs. Key barriers to

2018 Feasibility Assessment for Drayage Trucks –
Section 6: Assessment of Technical Viability

commercialization of Class 8 fuel cell trucks focus on their high total cost of ownership (incremental costs of the vehicles and hydrogen fuel), and the “lack of easily accessible fueling infrastructure.”

- **NZE NG** drayage trucks powered by the larger, more powerful 12-liter CWI engine are now fully commercial products at the **TRL 9** level. They offer very high “potential market penetration.” CARB refers to this as “the most significant status change” involving low-NOx ICE platforms, because “the emergence of this engine as a commercial product brings low NOx technology to drayage, regional delivery and some line haul applications.”
- **NZE PHEV** drayage trucks are currently in the **TRL 5 to TRL 6** range and “moving to pilot stage” (similar to ZE FC drayage trucks). They are measurably less mature (technologically and commercially) than “pure” BE drayage trucks, although they may offer significantly longer driving ranges. Despite this advantage, PHEV drayage trucks show a lower “potential market penetration” than their pure battery-electric and fuel cell truck counterparts. CARB notes that the “rapid emergence” of heavy-duty BE platforms has generally slowed OEM development of PHEV platforms.

6.4. Additional References for Assessing Technical Viability

Several other recent, relevant studies have objectively assessed the evolving technical and commercial viability of ZE and/or NZE heavy-duty trucking platforms. Below, findings from two key reports are summarized for relevancy to Class 8 drayage trucks; both reports are specifically focused on ZE battery-electric platforms.

North American Council on Freight Efficiency (NACFE) - In mid-2018, NACFE published a guidance report⁵² titled “Electric Trucks – Where They Make Sense”.⁵³ The 2018 NACFE report assessed the overall market maturity and technical viability of battery-electric trucks (from Class 3 up to Class 8) for use in commercial fleets. To help

Table 11. “Hot button” vehicle-specific issues identified by NACFE for Class 8 battery-electric trucks

| Issue Topic | Summary of NACFE’s Findings Relevant to Class 8 Drayage Trucks |
|---|--|
| Technology Readiness | Multiple companies are just entering the battery-electric truck market, including established OEMs selling Class 8 models. Battery-electric trucks will continue to benefit from advancements with electric autos and buses. In particular, battery specific energy (Wh/kg) is expected to continue improving. Rapid improvements are expected, overall. |
| Tradeoffs: Weight and Payload | Competitive vehicle tare weights are possible in all classes for many duty cycles, and typical payloads in many applications are well below maximum GVWR. Some truck applications offer BE truck models that can provide “equivalent freight carrying capacity.” However, Class 8 drayage is not yet one of those applications. |
| Total Cost of Ownership (TCO) | Industry pricing (CapEx) remains “largely ill defined,” and “based on prototype and pre-production” offerings. Battery prices (the largest single cost) are decreasing, and OpEx can be lower. However, many variables impact TCO (e.g., grants, tax breaks and incentives; and “a largely unknown residual or salvage value.” Alternatives to traditional purchasing or leasing are emerging to help end users attain a positive ROI. Vehicle life looks acceptable. |
| Source: Summarized (by the authors, emphasis added) from Section 31 of referenced NACFE report. | |

⁵² NACFE describes itself as “an unbiased, fuel agnostic organization” that “supports development of efficient, environmentally beneficial, and cost-effective freight technologies” for North American markets. NACFE’s guidance reports are designed to inform commercial truck fleets about the benefits, challenges and payback of emerging truck technologies, to “help develop confidence in their adoption.”

⁵³ North American Council for Freight Efficiency, “Guidance Report: Electric Trucks – Where They Make Sense”, May 2018, obtained directly from NACFE ([available online at https://nacfe.org/report-library/guidance-reports/](https://nacfe.org/report-library/guidance-reports/)).

2018 Feasibility Assessment for Drayage Trucks –
Section 6: Assessment of Technical Viability

trucking companies weigh strengths and weaknesses of commercial battery-electric trucks relative to conventional diesel trucks, the report discussed numerous technology-specific “hot button” issues (real or perceived). Table 11 lists these key issues, and summarizes NACFE’s internal findings regarding the status of each issue for battery-electric commercial trucks, as relevant to Class 8 heavy-duty trucks.

The NACFE report concludes by providing an objective, comprehensive summary comparison between today’s “CBEVs” (commercial battery-electric vehicles) and their counterpart conventional diesel vehicles, across a wide array of specifications and operational parameters. NACFE prepared a separate comparison table for Class 7 and 8 CBEVs, recognizing that special challenges exist in heavy-heavy duty trucking applications (above 26,000 Gross Vehicle Weight Rating, or GVWR). The timeline for the comparison is from 2018 to 2030, and “beyond.” NACFE employs three simple ratings to compare Class 7 and 8 CBEVs: 1) worse, 2) parity, and 3) better. Table 12 provides the actual comparison (reprinted with NACFE’s permission).⁵⁴

⁵⁴ Ibid. Graphic courtesy of NACFE.

2018 Feasibility Assessment for Drayage Trucks –
Section 6: Assessment of Technical Viability

Table 12. NACFE’s comparison of Class 7 and 8 battery-electric trucks to diesel baseline trucks

| | | NOW | 2020 | 2025 | 2030 | BEYOND |
|--------------------------|------------------------------------|-------|--------|--------|--------|--------|
| WEIGHT | Tare Weight | Worse | | | Parity | Better |
| | Typical Freight Weight | Worse | Parity | Better | | |
| | Max Freight Weight | Worse | | | Parity | Better |
| COST | Initial Cost | Worse | | | | Parity |
| | Net After All Factors | Worse | | Parity | Better | |
| | Operating Cost | Worse | | Parity | Better | |
| | Residual Value Used Market | Worse | | | Parity | Better |
| | Residual Value Salvage/Repurposing | Worse | | | Parity | Better |
| MAINTENANCE EFFORT | Service Center | Worse | | | Parity | Better |
| | Remote Diagnostics | Worse | Parity | Better | | |
| | Breakdown Recovery | Worse | | | Parity | Better |
| VEHICLE LIFE | 10-Year Service Life | Worse | | Parity | Better | |
| | Max Life Before Obsolete | Worse | | | | Parity |
| RANGE | Typical Daily Range | Worse | | Parity | Better | |
| | Max Daily Range | Worse | | | Parity | Better |
| ELECTRICITY AVAILABILITY | Yard “Fueling” | Worse | | Parity | Better | |
| | Truck Stop “Fueling” | Worse | | | | Parity |
| | “Fuel” Pump | Worse | | Parity | Better | |
| | “Refill” Time | Worse | | | | |
| GENERAL | Overall Technology Maturity | Worse | | | | Parity |
| | Safety | Worse | Parity | Better | | |
| | Environment | Worse | Parity | Better | | |

Key: Comparison to ‘Equivalent’ Diesel Baseline: ■ Worse ■ Parity ■ Better

As the table shows, NACFE concluded that Class 7 and 8 CBEVs are likely to achieve “parity” with their counterpart diesel (baseline) vehicles by 2020 in one important operational area: “typical freight weight.” However, parity is not achieved until 2030 for “tare weight” and “maximum freight weight”. These important weight- and cargo-related parameters are discussed further under “Assessment of Operational Feasibility” (Section 7).

Most relevant to this section, NACFE’s report concluded that Class 7 and 8 CBEVs will not achieve parity for “Overall Technology Maturity” until the 2030 timeframe.

NACFE’s key conclusions from this report include the following (as relevant to Class 8 trucks suitable for drayage):

2018 Feasibility Assessment for Drayage Trucks –
Section 6: Assessment of Technical Viability

- Battery-electric vehicles will have an increasing role in freight transportation in Class 3 through Class 8. Suitability to replace diesel trucks “is very dependent on vehicle class and duty cycle.”
- The transition to battery-electric trucks in specific market segments “will be drawn out over decades, sharing space with traditional diesel and gasoline powertrains and also competing with other new technologies like fuel cells and hybrids.”
- Battery-electric trucks “will not be a solution for every market.” Heavy-duty fleets with a mix of fuel-technology platforms (e.g., diesel, natural gas, hybrid and battery-electric) that are optimized for specific routes and duty cycles “will likely be the norm through 2050.”
- Early adopters will be in the urban delivery Class 3 through 6 segments; battery-electric Class 7 and 8 trucks will most likely be restricted to specific operations that are not as sensitive to higher weight and shorter driving ranges.
- For Class 7 and 8 trucking segments, battery-electric offerings “currently exist as prototypes or limited pre-production units in field testing,” and returns on investments (ROIs) in these segments “are less clear” today “due to the limited information on actual products” and projections that are being made from light-duty and transit bus applications.
- Commercial battery-electric vehicles must be reliable; to date, fleet experiences “have largely been with small volumes of vehicles produced by smaller manufacturers,” which have “experienced typical learning curve issues with new product introductions.” Reliability will improve as increasing numbers of OEM vehicles are deployed in fleet operation, followed by production that will provide fleets with “long-term stability.”
- “Actual commercial products” from several major Class 7/8 OEMs “are projected in the 2019–2020 timeframe.”

NACFE on Adoption Curve for New Truck Technologies

New model technology has a learning curve stressed by field deployments. New technology has a history of going through growing pains before stabilizing. This is related to production volumes in commercial use discovering design and reliability issues not found during limited volume testing. This period of learning typically sees higher service and maintenance costs and labor. Downtime is another factor for fleets. Parity with respect to new electric vehicle technologies requires accumulation of a significant number of miles and seasons of experience in real world operations. Diesels, by contrast, have decades of field history so are less likely to have these infancy issues.

NACFE, “Electric Trucks: Where They Make Sense”, 2018

2018 Feasibility Assessment for Drayage Trucks –
Section 6: Assessment of Technical Viability

The International Council on Clean Transportation (ICCT) – ICCT is an independent nonprofit organization that provides “unbiased research and technical and scientific analysis to environmental regulators.”⁵⁵ ICCT has prepared numerous reports about how to improve the environmental performance and energy efficiency of America’s heavy-duty transportation sector. This includes ICCT’s November 2017 white paper titled “Transitioning to Zero-Emission Heavy-Duty Freight Vehicles”.⁵⁶ Citing CARB’s 2015 Technology & Fuels Assessment and work in 2016 by the National Renewable Energy Laboratory, the ICCT report notes that plug-in electric vehicles are theoretically able to meet the technical viability and operational feasibility requirements found in many heavy-duty vehicle applications. Specifically:

“These vehicles are most suited for applications with short ranges and duty cycles that can take advantage of regenerative braking and where required electric battery packs sizes are lower. An analysis of duty cycles suggests urban delivery vans and delivery trucks, refuse trucks, and drayage trucks as targets for electrification.”⁵⁷

However, the ICCT report cites several “prevailing barriers to widespread viability” of plug-in electric heavy-duty freight vehicles. It notes that heavy-duty battery-electric technology for heavy-duty trucking presents “a combination of near- and long-term barriers, issues, and questions,” all of which must be addressed before they can widely replace conventional diesel trucks. On the vehicle side, ICCT cites the following specific barriers:

- Limited electric range
- High vehicle cost (primarily related to the battery pack)
- Long recharging time (“unless battery swapping is utilized”)
- Tradeoffs on cargo weight and/or volume

Notably, these barriers for battery-electric trucks are accentuated for Class 8 (>33,000 lbs GVWR) trucks that will be needed for drayage trucking. Consequently, the ICCT report does not specifically cite drayage trucking as a “promising segment for widespread commercialization” of battery-electric drivetrains. Instead, ICCT cites the following Class 4 to 7 categories: light commercial urban delivery vans, medium-duty regional delivery trucks, and refuse trucks.

However, the ICCT report discusses two other types of zero-emission electric-drive architectures for drayage trucking applications that currently offer “wide-scale commercialization potential.” These are:

- “Dynamically charged” grid electric – ICCT notes that grid-connected mechanisms like overhead catenary wires, on-road conductive tracks, or in-road inductive wireless charging could help unlock the many potential advantages and market options for electric trucks, by removing the barriers listed above. However, ICCT acknowledges that the buildout of dedicated freeway lanes and grid-connected charging systems will entail significant costs and present formidable logistics challenges, such as the need to standardize truck technology and infrastructure systems across regions.

⁵⁵ The International Council on Clean Transportation, “Mission and History,” <https://www.theicct.org/mission-history>.

⁵⁶ Moultak, M., Lutsey, N., Hall, D., “Transitioning to Zero-Emission Heavy-Duty Freight Vehicles,” The International Council on Clean Transportation (ICCT), September 26, 2017, <https://www.theicct.org/publications/transitioning-zero-emission-heavy-duty-freight-vehicles>.

⁵⁷ Ibid, page 7.

2018 Feasibility Assessment for Drayage Trucks –
Section 6: Assessment of Technical Viability

- Fuel cell electric – ICCT notes that heavy-duty hydrogen fuel cell vehicles “have an especially important opportunity” to provide zero emissions “in applications for which plug-in and dynamic charging is difficult practically or from a cost perspective.” As previously described, fuel cell technology offers significantly faster fueling times compared with electric charging times. ICCT notes that this feature is “of great importance to many truck fleets that cannot accommodate additional downtime within their freight activity patterns.” Automotive fuel cell engines offer the potential for “much greater range” than battery-electric trucks with similar specifications. The ICCT report concludes that fuel cell trucks offer “especially strong potential in urban fleets, where governments have prioritized hydrogen infrastructure deployment, and for long-haul tractor-trailer fleets with routes around and between those cities.” However, it also identifies hydrogen fuel supply issues as being “a key challenge” for fuel cell trucks.

In sum, the ICCT report highlights various reasons why heavy-duty truck OEMs are likely to increasingly incorporate both battery-electric and hydrogen fuel cell architectures into their on-road truck models. Like the other references cited above, however, the ICCT report highlights Class 8 drayage trucking as being one of the more-challenging on-road applications for ZE platforms. The ICCT report is consistent with the general finding that a commercial transition for this application is likely to occur gradually over the next decade.

6.5. Summary of Findings for Technical Viability

The Technical Viability parameter evaluated under this 2018 Feasibility Assessment for Drayage Trucks is closely related to the previous parameter (Commercial Availability), as well as the parameter that follows (Operational Feasibility). All three parameters are measures of technological maturity for emerging ZE and NZE Class 8 trucking platforms, and their ability to meet needs of the LMCs for acceleration, gradeability, driving range, fueling time, durability / reliability, safety and others (see Section 7 on Operational Feasibility).

To specifically gauge technical viability, the study authors assigned TRL ratings (based on the U.S. DOE’s scale and definitions) to a mix of ZE and NZE platforms that appear to have the best potential for broad incorporation into the San Pedro Bay Ports drayage fleet over the next several years. **TRL 8** is the stage at which a given platform becomes near-final or final, and has adequately exhibited technical viability through test and demonstration. TRL 9 constitutes DOE’s highest rating; this is the stage at which full technical viability has been achieved and definitively documented.⁵⁸

Table 13 (the third column) summarizes this Assessment’s findings (as of late 2018) for the TRL ratings of leading Class 8 truck fuel-technology platforms that are in development and/or commercialization by major OEMs. These TRL ratings are specific to drayage truck operation at the San Pedro Bay Ports. The fourth column provides an “educated prognosis” for how each TRL rating may change (improve) by 2021 (or sooner). The last column provides additional rationale for each prognosis. These TRL ratings and findings are in essential agreement with similar assessments and findings by CARB and other key agencies, as discussed above.

⁵⁸U.S. Department of Energy, “Technology Readiness Assessment Guide”, September 15, 2011, page 9, <https://www.directives.doe.gov/directives-documents/400-series/0413.3-EGuide-04a/@@images/file>

2018 Feasibility Assessment for Drayage Trucks –
Section 6: Assessment of Technical Viability

Table 13: Summary: 2018 Technical Viability using TRL values (with 2021 prognoses)

| TRL | Relative Stage of Development | Late-2018 TRLs for Leading Fuel-Technology Platforms (Drayage) | ~2021: Educated Prognoses (by or before) | Comments / Basis for 2021 Educated Prognosis |
|-------|-------------------------------|--|--|--|
| TRL 9 | Systems Operations | | NZE NG ICE (TRL 9) | NZE NG ICE: to reach TRL 9 in Class 8 port drayage, new NZE 12-liter engine <u>needs operational time</u> |
| TRL 8 | Systems Conditioning | NZE NG ICE (TRL 8) | ZE Battery (TRL 8) | ZE Battery Electric: strong progress in transit bus / MDV sectors is likely to advance Class 8 drayage use; ongoing range challenge may <u>limit</u> to short-haul applications |
| TRL 7 | | ZE Battery (TRL 6 to 7) | ZE Fuel Cell or NZE Plug-in Hybrid (TRL 7??) | |
| TRL 6 | Technology Demonstration | ZE Fuel Cell or NZE Plug-in Hybrid (TRL 5 to 6) | NZE Diesel ICE (TRL 5, or higher?) | ZE Fuel Cell: biggest remaining hurdles relate to total cost of ownership, including access to / on-board storage of hydrogen fuel; NZE Plug-in Hybrid: prognosis is a wild card; OEM interest is hard to gauge, but plug-in architecture enables valued "zero-emission mile" capability |
| TRL 5 | Technology Development | NZE Diesel ICE (TRL 5) | | |
| TRL 4 | | | | NZE Diesel ICE: <u>could</u> "leapfrog" to TRL 8 or 9, but <u>only if</u> suitable diesel engine(s) get certified to 0.02 g/bhp-hr NOx (or other CARB OLSN) |

Source: TRL methodology adapted from U.S. DOE, "Technology Readiness Assessment Guide, Table 1: Technology Readiness Levels, September 2011 (see footnote). TRL ratings estimated based on input from 1) OEM surveys, 2) various technical reports, 3) demonstration activities, and 4) meetings with agency technical personnel (CARB, CEC, SCAQMD).

Below are summaries about the estimated TRL ratings presented in the above table, and the rationale on which they are based:

ZE BE – Battery-electric drayage trucks are currently at a technological maturity stage between TRL 6 (Early Stage Demonstration) and TRL 7 (Advanced Pilot Demonstration). As of mid-2018, Class 8 battery-electric trucks are essentially pre-commercial products that are just beginning to provide real-world operational data. Under current battery technology, they do not provide the minimum range of 600 miles needed for broad use in regional drayage trucking (see Section 0). Still, many ZE BE Class 8 drayage trucks are expected to be demonstrated in drayage service over the next one-to-two years, with involvement of several major OEMs. With such large resource allocations, this platform may emerge solidly into the TRL 7 to TRL 8 range by 2021. As such, ZE BE Class 8 trucks would begin to cross the threshold into becoming technically viable for drayage service, although battery technology will likely continue to limit this to shorter-range cargo moves.

ZE FC – Hydrogen fuel cell platforms for Class 8 drayage trucks are currently at **TRL 5 to 6** (Technology Development and Demonstration). Especially for Class 8 truck applications, hydrogen fuel cells lag behind ZE BE platforms, for

2018 Feasibility Assessment for Drayage Trucks –
Section 6: Assessment of Technical Viability

both technological and commercial maturity. This is largely related to complexities and costs of hydrogen fuel, but there are also cost and technology challenges associated with fuel cell drivetrains. As CARB has recognized, hydrogen fuel cell platforms show good long-term potential for penetrating deeply into the San Pedro Bay Ports drayage fleet. They offer a compelling combination of longer range, rapid fueling time and good efficiency. It is estimated that Class 8 fuel cell trucks suitable for drayage may move up to **TRL 7** by the end of 2021, as several key new demonstrations are or will soon be underway. However, achieving TRL 8 (the threshold for initial commercialization) appears to be unlikely in drayage applications before the 2025 timeframe.

NZE NG – This is the only fuel-technology platform for Class 8 drayage trucks that currently achieves a TRL rating of at least 8 (end of Systems Conditioning). Based on DOE’s definitions, TRL 8 is the threshold for proof of Technical Viability. Class 8 natural gas drayage trucks are likely to move into TRL 9 by 2020. (Several experts queried by the authors have indicated that this fuel-technology platform is already at TRL 9 for Class 8 heavy-duty truck applications, in general.) Over the next 12 months, at least 22 units (and probably significantly more) will be gaining important operational experience in drayage under “a full range of operating mission conditions.” Largely, the key remaining accomplishment is to give end users full confidence that this fuel-technology platform can truly provide diesel-equivalent performance.

Other contending **ZE** and **NZE** Class 8 truck platforms – These are all currently in the **TRL 5 to 6 range** (technology development and demonstration). This includes **ZE** direct-grid electric (e.g., overhead catenary), **NZE** hybrid-electric, and **NZE** diesel ICE platforms. Each has advantages, opportunities, challenges and tradeoffs associated with their potential use in drayage applications. However, none are commercially available today in Class 8 truck configurations, and insufficient information currently exists to accurately assess their technical viability over the next three years.

NZE diesel ICE technology appears to be a wildcard among these platforms. Currently, there are no heavy-duty diesel engines certified below current federal standards (i.e., none have been certified yet to a CARB OLNS). However, government-industry efforts are underway to develop such engines.⁵⁹ It is likely that all major OEMs and aftertreatment technology providers are collaborating on next-generation ultra-low technologies for heavy-duty diesel engines. Engine OEMs and industry experts generally agree that one or more OLNS certifications could happen by 2021, or sooner. Should it occur, certification of heavy-duty diesel engine technology to CARB’s lowest-tier OLNS (0.02 g/bhp-hr of NOx) will represent a major development in the feasibility of NZE drayage trucks. As a result, Class 8 NZE diesel trucks could leapfrog from their current TRL 5 (early development) all the way up to **TRL 7 or 8**. Moreover, **TRL 9** could likely follow relatively quickly, after sufficient revenue-service demonstrations have been completed. This will be equivalent to the TRL status already achieved by the NZE natural gas engine platform.

⁵⁹For example, CARB, SCAQMD and EPA are overseeing work at Southwest Research Institute to develop commercially viable advanced diesel engines that achieve CARB’s lowest-tier OLNS of 0.02 g/bhp-hr. See http://www.aqmd.gov/docs/default-source/Agendas/Technology/3-17-17_tech-cmte.pdf.

2018 Feasibility Assessment for Drayage Trucks –
Section 6: Assessment of Technical Viability

6.6. Implications to Remainder of 2018 Feasibility Assessment for Drayage Trucks

The methodology of this 2018 Feasibility Assessment for Drayage Trucks initially applied two key parameters, Commercial Availability and Technical Viability, to screen leading Class 8 fuel-technology platforms. Those that currently meet the basic criteria and considerations for Commercial Availability and Technical Viability (or exhibit strong likelihood to achieve them soon) were selected for further assessment, by applying the remaining three parameters (Operational Feasibility, Infrastructure Availability, and Economic Considerations).

The rationale for this is straightforward. Until a particular fuel-technology platform has 1) achieved (or is approaching) the minimum threshold for technical viability, and 2) become (or can soon become) a fully certified product offered by a major Class 8 truck OEM, it is premature and overly speculative to evaluate its potential for broad-scale deployment in the San Pedro Bay Ports' drayage fleet by 2021 (the timeframe of this study).

Consequently, the remainder of this 2018 Assessment focuses on further characterizing the feasibility of Class 8 drayage trucks powered by two fuel-technology platforms that meet the above tests today: 1) **ZE** battery-electric and 2) **NZE** natural gas ICE.

Important Notes:

- 1) Nothing in this 2018 Feasibility Assessment for Drayage Trucks precludes or discourages expanded development, demonstration and deployment of pre-commercial ZE and NZE fuel-technology platforms that have not yet reached TRL 8. In fact, both Ports are already supporting efforts to test a variety of truck platforms with TRL ratings in the 5-to-7 range. This is especially true in cases that include major involvement and cost sharing by Class 8 truck OEMs (see Section 5.6).
- 2) This Assessment is a snapshot of drayage truck platforms for late-2018. The Ports intend to conduct the next feasibility assessment within three years, or sooner if technological and market conditions warrant an accelerated schedule.

7. Assessment of Operational Feasibility

7.1. Background: Criteria and Methodology

Operational feasibility for a given drayage truck type refers to its ability to meet the essential needs of San Pedro Bay Ports' drayage companies to efficiently, affordably and safely move cargo to and from the Ports. The fundamental question for any emerging fuel technology platform is: will it be able to move containers (or other cargo) as well as – and preferably better than – the baseline diesel technology which it is intended to replace?

It is difficult to overstate the importance of end users (drayage trucking companies) gaining real-world experience with – and confidence in – the operational feasibility of any emerging drayage truck platform before widely deploying it in revenue service. To date, trucking companies have not had much opportunity to gain much operational experience on emerging ZE and NZE drayage truck platforms. This is especially true for the two leading ZE architectures (battery-electric and hydrogen fuel cell). Fortunately, over the next 18 months that is expected to change significantly, as there are many important demonstration programs just getting underway (see Section 5.6).

For example, the South Coast Air Quality Management District (SCAQMD) is working with the San Pedro Bay Ports to help expedite large-scale commercialization of Class 8 drayage trucks powered by the two leading ZE fuel-technology platforms, battery-electric and hydrogen fuel cell. During the governing board approval process to cost-share a \$31 million major new project that will demonstrate battery-electric drayage trucks, SCAQMD staff made the following point about the important need to obtain revenue service operational data on pre-commercial Class 8 battery-electric trucks, specifically for application in San Pedro Bay Ports drayage trucking:

“There has been an increased interest in the marketplace for zero emission trucks including battery-electric technology in the heavy-duty goods movement sector, and the adoption of the San Pedro Bay Ports’ Clean Air Action Plan has further stimulated this interest among fleets and others. While the benefits of electric drive vehicles are widely accepted, the cost of the technology and the availability of charging assets needs to be carefully considered and planned for implementing new technology programs. Additionally, OEMs are in desperate need of operational data and available vehicles to provide this data. Daimler Trucks North America LLC (DTNA), the world’s leader in heavy-duty truck sales, proposes to implement the Daimler Zero Emission Trucks and EV Infrastructure Project.”⁶⁰

Table 14 below lists the criteria that have been applied (within the scope and timeline of this assessment) to evaluate if various fuel-technology platforms for drayage trucks can meet base considerations to be deemed operationally feasible. As shown, these base considerations focus on post-purchase parameters from the end users perspective, including those that are vehicle-related (e.g., power, torque, acceleration and handling, fuel economy / range, driver comfort, availability of replacement parts) and those that are facility-related (e.g., fueling logistics, required time to fuel, need for facility upgrades).

⁶⁰South Coast Air Quality Management District, “Recognize and Transfer Revenue and Execute Contract to Develop and Demonstrate Zero Emission Trucks and EV Infrastructure,” Governing Board Agenda No. 4, July 6, 2018, <http://yourstory.aqmd.gov/docs/default-source/Agendas/Governing-Board/2018/2018-july6-004.pdf?sfvrsn=2>.

2018 Feasibility Assessment for Drayage Trucks –
Section 7: Assessment of Operational Feasibility

Table 14: Criteria for establishing Operational Feasibility for emerging drayage truck platforms.

| Operational Feasibility Criteria / Issue | Base Considerations for Assessing Operational Feasibility |
|---|---|
| Basic Performance | Demonstrated capability to meet drayage company needs for basic performance parameters including power, torque, gradeability, operation of accessories, etc. |
| Range | Demonstrated capability to achieve per-shift and daily range requirements found in San Pedro Bay drayage. |
| Speed and Frequency of Fueling / Charging | Demonstrated capability to meet drayage company needs for speed and frequency to fuel / charge such that revenue operation is not significantly reduced relative to diesel baseline. |
| Driver Comfort, Safety, and Fueling Logistics | Proven ability to satisfy typical drayage trucking company's needs for comfort, safety and fueling procedures. |
| Availability of Replacement Parts and Support for Maintenance / Training | Verifiable existence of and timely access to (equivalent to baseline diesel) all replacement parts needed to conduct scheduled and unscheduled maintenance procedures. |
| | Verifiable existence of maintenance procedure guidelines and manuals, including OEM-provided training courses upon purchase and deployment of new trucks. |
| Affordable Access to Vehicle-Specific Facility Modifications | Proven ability for drayage fleets to gain affordable access to any new facility upgrades and modifications that will be necessary to house, service, maintain, and/or refuel/recharge a given drayage truck fuel-technology platform. |
| Source: Based on criteria in San Pedro Bay Ports’ “Framework for Developing Feasibility Assessments,” November 2017. | |

7.2. Drayage Company Survey: Scope and Results

To assess operational feasibility, it was important to first understand key operational metrics associated with the drayage vocation at the San Pedro Bay Ports. However, existing reports lack sufficient detail to adequately inform this process. Consequently, an on-line survey was prepared and distributed to all companies registered in the San Pedro Bay Ports Drayage Truck Registry (PDTR). Additionally, the survey was sent to the Harbor Trucking Association (HTA) and California Trucking Association (CTA), which then distributed this CTP Truck Operator Survey to their membership. Written responses to the survey were received from a total of 97 companies, representing an estimated 3,300 port trucks (roughly one third of the active fleet, at any given time).

This survey queried drayage truck operators about basic operational requirements, purchase costs, and annual maintenance costs. These results appear to be indicative of the breadth of drayage operations, but they should not be considered an exhaustive assessment, and the responding operators are not necessarily representative of the full population. Drayage is a complex trucking vocation, with a broad range of daily operational needs that vary from fleet-to-fleet and from day-to-day. Specific examples are discussed below.

Maximum Shift Distance - Figure 7 depicts the distribution of survey responses indicating the maximum distance travelled by drayage trucks during a single shift. The number of survey responses for each mileage bin are shown,

2018 Feasibility Assessment for Drayage Trucks –
Section 7: Assessment of Operational Feasibility

along with the total number of trucks represented by those responses. The broad distribution of responses is indicative of the varying driving range requirements that different fleets and trucks experience.

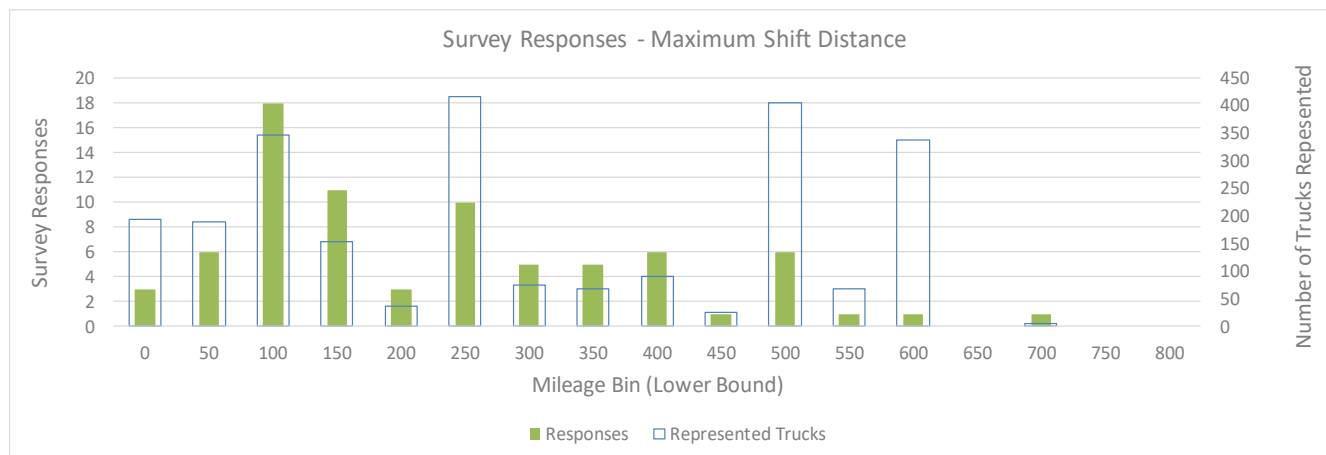

Figure 7. Distribution of survey responses for "maximum shift distance"

Figure 8 provides distributions of survey responses to four additional key operational parameters; average shift distance, average shift duration, average shifts per day, and average loaded operating weight. Results of the survey data for other questions and derived metrics used in this report are provided in Appendix C.

Average Shift Distance – The weighted average shift distance is 160 miles, while the highest average distance reported is 300 miles. As the figure shows, the most common response was 100 miles, the majority of trucks are represented by responses of 150 to 300 miles per shift. This indicates that larger fleets of drayage trucks are more likely to report higher average shift distances than smaller fleets.

Average Shift Duration – Responses were bounded between 8 and 11.5 hours, with a weighted average of 9.9 hours. The most common response was 10 hours.

Average Shifts per Day – Responses were predominantly binary, reporting either one shift or two shifts per day. Approximately half of the trucks represented are reported to average more than one shift per day. Combined with an average shift duration of 10 hours, drayage trucks typically operate either 10 hours per day or 20 hours per day. A truck operating 20 hours per day is achieved through “slip seating” of drivers, wherein the truck stops between shifts only long enough to exchange drivers and refuel, if necessary. A 20-hour daily operating period has significant implications for fueling/charging strategies and range requirements. To support these long operating periods, the truck must either: 1) fuel/charge in less than five hours and have sufficient range to serve two shifts, or 2) fuel/charge with diesel-like times (~15 minutes) between shifts.

Average Loaded Operating Weight – Responses indicated two broad categories of operating weights: 1) 30,000 to 40,000 lbs, and 2) 60,000 to 93,000 lbs. The bimodal distribution seen in the responses is typical of goods movement, where some trucks “cube out” (are limited by cargo volume) and some “weight out” (are limited by cargo weight). The majority of responses indicated typical operating weights of 60,000 to 80,000 lbs, suggesting the majority of trucks weight out, or come close to weighting out hauling relatively heavy cargo. Because most highways and interstates have an 80,000 lbs weight limit, trucks operating above this limit are likely traveling on specially designated overweight corridors hauling overweight containers or break-bulk loads.

**2018 Feasibility Assessment for Drayage Trucks –
Section 7: Assessment of Operational Feasibility**

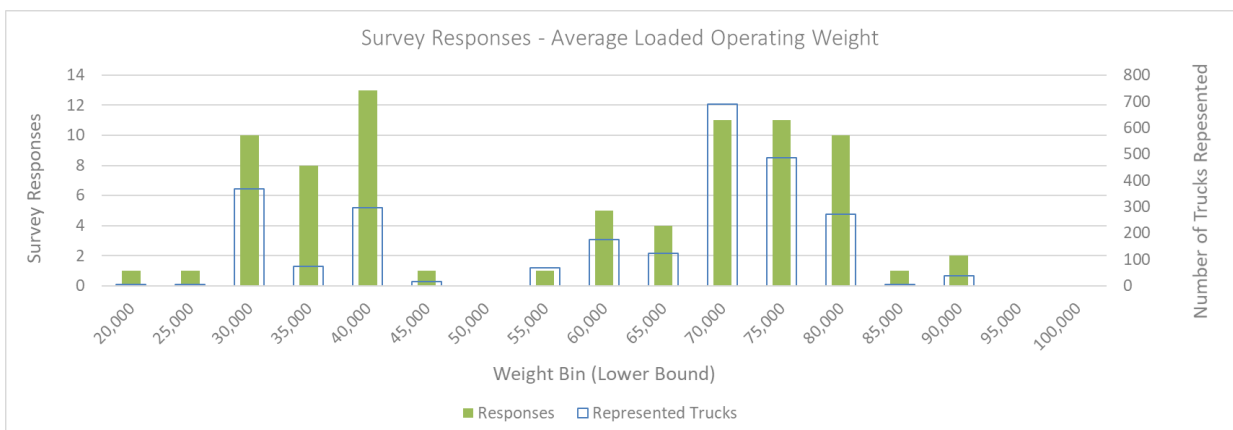
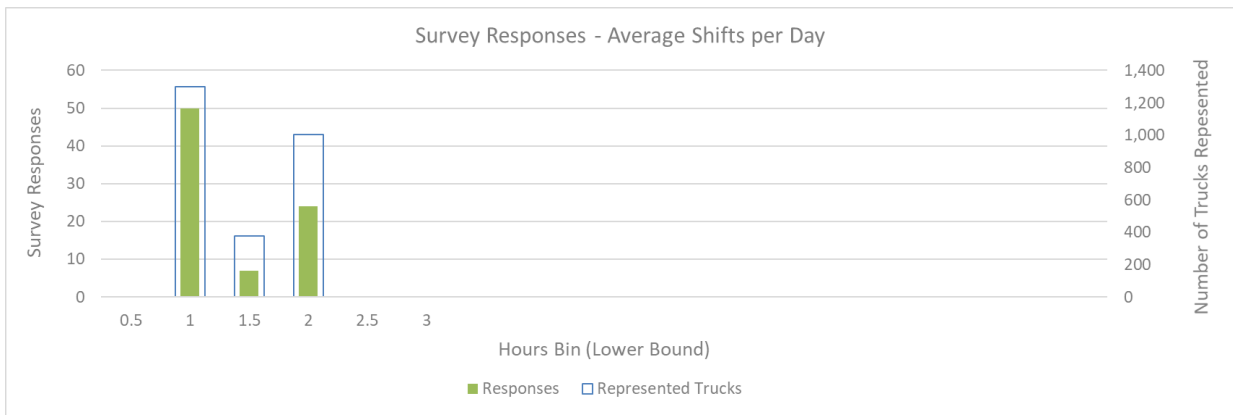
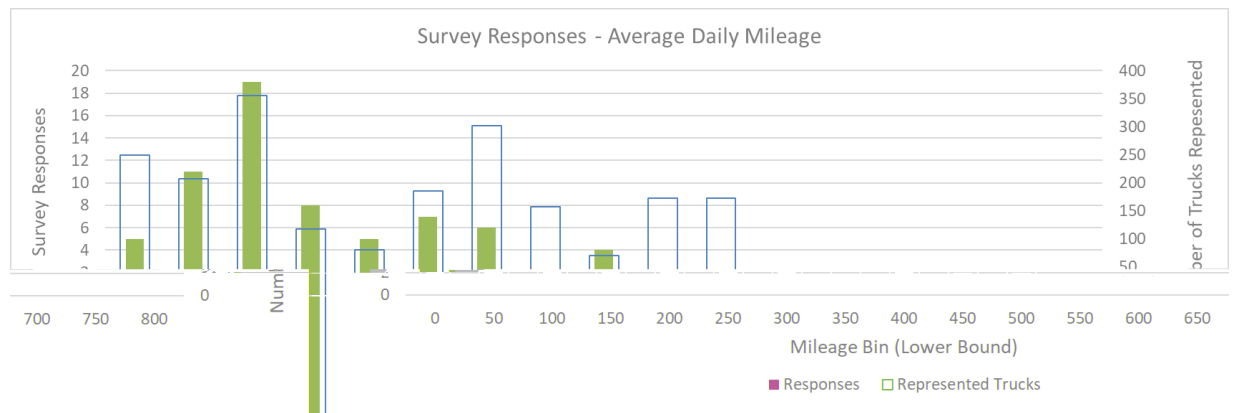
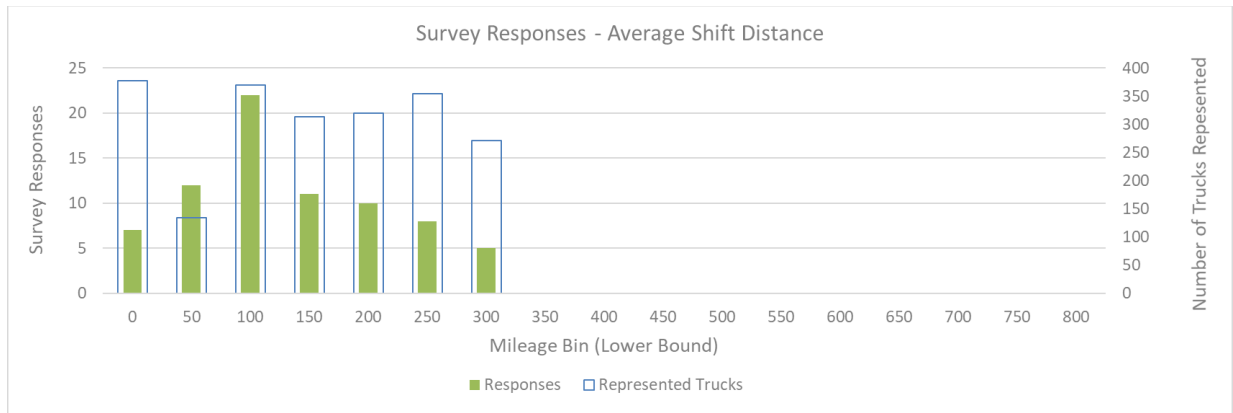

Figure 8: Survey response distributions for key operational parameters

2018 Feasibility Assessment for Drayage Trucks –
Section 7: Assessment of Operational Feasibility

7.3. Comparison of Survey Findings to Other Studies

Four existing reports were identified that, to some degree, describe operational parameters for drayage trucks serving the San Pedro Bay Ports. Key operational parameters from these studies are summarized in Table 15 (references 1 through 4), and compared to corresponding parameters from the CTP Truck Operator Survey (summarized in the final column).

Table 15 . Comparison of drayage truck operational parameters from identified studies

| Operational Parameter | Units | Ref. 1. UC Irvine/ KRRRI Study | Ref. 2. Ports' Zero Emission Roadmap | Ref. 3. Ports' NZ and ZE Drayage Demonstration Guidelines | Ref. 4. LA Metro Study of Drayage Truck Performance Parameters for I-710 | CTP Truck Operator Survey |
|---|---------|--------------------------------|---|---|--|--|
| Study Date | | 2017 (2010 data) | 2011 | 2016 | 2013 | 2018 |
| Average Trip Distance (one-way) | miles | 23.57 | 5 miles | Not reported | 40 | Not reported |
| Average Trips per Day | #/day | 6.22 | Not reported | Not reported | 3-5 | Not reported |
| Maximum Shift Distance | miles | >170 | Not reported | Not reported | Not Reported | 600 |
| Average Shift Distance | miles | Not reported | Not reported | Not reported | 120-200 | 160 |
| Average Shift Duration | hours | Not reported | Not reported | Not reported | 10-14 | 9.9 |
| Average Shifts per Day | #/day | Not reported | Not reported | Not reported | 1 | 1.6 |
| Maximum Shifts per Day | #/day | Not reported | Not reported | Not reported | 2 | 2 |
| Average Daily Operating Time | Hours | Not reported | Not reported | Not reported | 10-14 | 14.8 |
| Average Daily Mileage | miles | 146.6 | Not reported | Not reported | 120-200 | 238 |
| Maximum Daily Mileage | miles | Not reported | Not reported | Not reported | 200 | 800 |
| Maximum Weight (GCWR) | lbs | Not reported | 80,000 | 66,000 | 10,000-90,000 | 80,000 |
| Top Speed (0% grade) | mph | Not reported | 50+ | 60 | 65 | Not reported |
| Gradability @0 mph | % grade | Not reported | 20% | 15% | Not reported | Not reported |
| Gradability @40 mph | % grade | Not reported | 6% | 6% | 6% | Not reported |
| Intervals between fills (time, shifts, miles) | | Not reported | 1 shift (8 hours) or diesel-like fill times | 80 miles, or 40 miles with opportunity charging/ fueling | Prefer range between fueling to be 2+ days. Refueling times of 20-30 minutes | 2 shifts, with less than 5 hours for charging/ fueling, or diesel-like refueling times |

Note: **Green** text indicates values used to define “Broadly Applicable Truck” (BAT)

Report references:

1. You, S. and Ritchie, S., “A GPS Data Processing Framework for Analysis of Drayage Truck Tours” *Transportation Engineering*, July 2017, eISSN 1976-3808.
2. Port of Long Beach and Port of Los Angeles, “Roadmap for Moving Forward with Zero Emission Technologies at the Ports of Long Beach and Los Angeles” August 2011.
3. Port of Long Beach and Port of Los Angeles, “Zero/Near-Zero Emissions Drayage Truck Testing & Demonstration Guidelines” July 2016.
4. Papson, A. and Ippoliti, M., “Key Performance Parameters for Drayage Trucks Operating at the Ports of Los Angeles and Long Beach” November 2013.

7.3.1. Discussion of Specific References and Relevant Findings

Reference 1 - A study by researchers at UC Irvine and the Korean Railroad Institute analyzed one year of GPS data from 481 LNG drayage trucks and 64 diesel drayage trucks funded under Proposition 1B. The analysis developed a unique methodology to assess drayage operations in the context of trips and “tours” (a series of linked trips). This is the only study identified that was based on actual vehicle GPS data over such a long timeframe. While the analysis detailed daily activity estimates for both LNG and diesel trucks, diesel trucks had significantly greater daily mileage accrual than LNG trucks (146.6 miles vs 101.3 miles). For the purposes of this feasibility assessment, the diesel truck data are assumed to be more representative of the broader drayage fleet than the LNG data owing to the diesel trucks’ greater operational flexibility and range at the time the study was conducted.⁶¹ While the underlying data set in this study is the most detailed and robust of the four studies considered, the analysis did not report a number of key parameters desirable for the current feasibility assessment.

References 2 and 3 - The referenced documents in the above table are two reports jointly published by the Ports to describe minimum operational requirements for drayage trucks. For example, the 2011 “Zero Emissions Roadmap” included minimum performance requirements for short-haul drayage. Those metrics described important operational parameters like top speed and maximum operating weight. However, they did not define a number of other operational parameters. Additionally, these metrics were only focused on short-haul drayage (mostly near-dock, some local), where it was envisioned that ZE technologies were most likely to initially be successful.

Reference 4 - As part of LA Metro’s I-710 Corridor project, a zero-emission truck commercialization study was commissioned. In support of that study, Metro conducted a survey of drayage truck operators serving the Ports to develop key performance parameters against which zero-emission technologies could be assessed. Unlike the previously discussed studies, this report sought to characterize the broader drayage market and assess a broad range of operational parameters. As shown in Table 15, the results of this study are generally in agreement with the results of the truck operator survey conducted as part of this feasibility assessment.

Importantly, the Metro report recognized the day-to-day variability of drayage operations and sought to define parameters for a “full-service truck” noting the following:

*“Because the drivers are independent contractors, dray companies are unable to designate specific trucks as limited-service trucks. For example, a truck can’t be limited to runs along the corridor, or short runs to and from the railyards. Every truck in the drayage fleet **must be a full-service truck**, able to complete any run.”⁶²*

7.4. Broadly Applicable Truck (BAT) Concept

Consistent with the above references, this Feasibility Assessment utilized the concept of a “broadly applicable truck” (BAT) to assist in assessing the Operational Feasibility parameter. A BAT is defined as being capable to perform the vast majority of drayage operations in the San Pedro Bay Ports’ fleet, and therefore is expected to meet the “maximum” performance requirements described in Table 16. Average performance requirements are used primarily to inform the economic and infrastructure analyses. It is recognized that this BAT definition sets a

⁶¹ As previously described, LNG trucks listed in the PDTR were predominantly equipped with 8.9L engines having horsepower ratings of only 320 HP; consequently, they were recommended for drayage applications with a GCW of 66,000 lbs or less.

⁶² Papon, A. and Ippoliti, M., “Key Performance Parameters for Drayage Trucks Operating at the Ports of Los Angeles and Long Beach”, November 15, 2013, page 14, http://www.calstart.org/Libraries/I-710_Project/Key_Performance_Parameters_for_Drayage_Trucks_Operating_at_the_Ports_of_Los_Angeles_and_Long_Beach.sflb.ashx

2018 Feasibility Assessment for Drayage Trucks –
Section 7: Assessment of Operational Feasibility

relatively “high bar” for operational performance, which emerging ZE and/or NZE technologies may not be able to meet today. This does not preclude the success of these technologies in niches within drayage. Similarly, the truck operator survey cannot capture every possible operator’s maximum performance requirements. Therefore, even a BAT may not meet the needs of every operator, for every cargo move.

The gradeability requirement (40 mph at 6%) warrants additional evaluation. As described in the Ports’ demonstration guideline document, this gradeability requirement is specified at 80,000 lbs GCW. To achieve this gradeability on a continuous basis would require approximately 640 HP. Approximately 540 HP is required to deliver the power to support the elevation change (change in potential energy of the vehicle) and 100 HP is required for aerodynamic losses, rolling resistance, auxiliary systems, and driveline losses.⁶³ This power rating is well outside the capabilities of nearly all on-road trucks in the U.S. Closer review of the guideline document clarifies that the gradeability requirement is intended to address the steepest grades experienced on the Vincent Thomas Bridge (although the approaches to the Heim and Gerald Desmond bridges also have similar maximum grades). The guideline document provides a bridge crossing test cycle that begins the approach at 50 MPH and declines to 30 MPH, requiring approximately 250 HP of continuous engine power. This 250 HP power demand is assumed to be equivalent to the intended gradeability requirement in the guideline document and is well within the capability of trucks currently serving the ports.

While the gradeability requirement for port bridge crossings is easily met by most Class 8 truck platforms, the requirement for a 6% gradeability has other relevant applications to drayage. Two major truck routes travelling north out of the basin are the I-5 and I-15 freeways. Both freeways have long grades of approximately 6% (the Tejon Pass on I-5 and the Cajon Pass on I-15) as they climb out of the basin and over the local mountains. A trip from the San Pedro Bay Ports to the top of either pass would require a 100-mile one-way trip, implying a 200-mile minimum shift distance for a single round trip. An analysis of the survey data indicates that trucks with an average shift distance of at least 200 miles have an average reported operating weight of 57,300 lbs. This is similar to a recent study of average heavy-duty vehicle weights that found the average weight of a Class 8 semi-tractor with single trailer was 59,000 lbs.⁶⁴

Figure 9 depicts the engine power required to climb a 6% grade at various speeds with GCWs of 57,300 lbs and 80,000 lbs. The majority of drayage trucks are equipped with engines producing 400-500 HP, implying that the gradeability of a typical drayage truck is 25 to 30 MPH at 6% grade and 80,000 lbs GCW, or 35 to 40 MPH at 6% grade and 57,300 lbs GCW. For the purposes of this feasibility analysis it is assumed that a 35 MPH sustained speed at the reported average GCW of 57,000 lbs is a reasonable benchmark and consistent with the range of trucks serving the ports. This implies a minimum engine horsepower rating of 400 HP or a tractive power rating (power at the rear wheels) of 320 HP. It is noted that fleets regularly traversing these mountain passes with loads near 80,000 lbs would see maximum sustained climbing speeds of 25 MPH and may not find such performance acceptable.

⁶³ National Research Council, “Review of the 21st Century Truck Partnership, Second Report”, The National Academies Press, 2012. Estimated power demand for aerodynamic losses, rolling resistance, auxiliary loads, and driveline losses are based on reported average load curves in Table 5-1 and Figure 5-1 of the referenced report.

⁶⁴ Carrigan, C. and Ray, M., “Assessment of the MASH Heavy Vehicle Weights for Field Relevancy”, 96th Annual Meeting of the Transportation Research Board, October 31, 2016, <http://docs.trb.org/prp/17-01043.pdf>

2018 Feasibility Assessment for Drayage Trucks –
Section 7: Assessment of Operational Feasibility

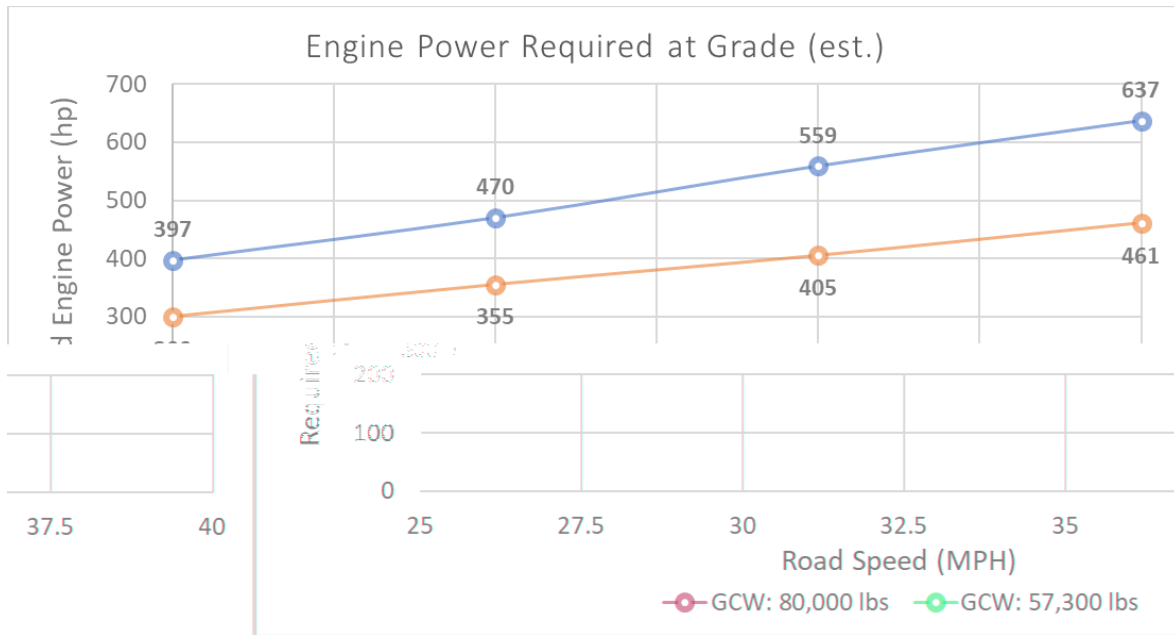

Figure 9: Estimated engine power required to sustain at a 6% grade

7.5. Application of Operational Feasibility Criteria

In this section, the performance assumptions previously summarized in Table 15 (derived from the noted sources) have been applied to further assess the operational feasibility of the two fully screened drayage truck platforms (ZE battery-electric and NZE natural gas ICE). Application of these assumptions helps measure which key criteria are met, which collectively provides a snapshot of operational feasibility.

The exercise to determine which of these two platforms can meet drayage operational requirements is dependent on configurations for existing products. For both platforms, manufacturer specifications for typical Class 8 day cab semi-tractors have been used as sources for typical performance ratings. While there are multiple make/model choices for natural gas ICE trucks, BYD's 8TT is the only Class 8 battery-electric drayage truck that fleets can purchase from an OEM (as noted, in an "early commercial" stage of development). Consequently, for this exercise the BYD 8TT specifications were assumed to be representative of a typical Class 8 battery-electric tractor.

7.5.1. Basic Performance

The basic performance parameters and requirements for BAT are defined in Table 16. These include top speed, gradeability, and Gross Combined Weight Rating (GCWR). These performance specifications do not explicitly set torque or horsepower requirements that are commonly used as a point of comparison between traditional ICE Class 8 trucks. This is because trucks based on electric drivetrains may not have directly comparable torque/horsepower specifications but can still achieve the gradeability, load, and top speed requirements for the vocation.

2018 Feasibility Assessment for Drayage Trucks –
Section 7: Assessment of Operational Feasibility

Table 16: Operational assumptions for a Broadly Applicable Truck (BAT)

| Operational Parameter | Units | Value |
|--|---------|--|
| <i>Minimum Operational Capabilities Needed</i> | | |
| Maximum Shift Distance | miles | 600 |
| Maximum Shifts per Day | #/day | 2 |
| Maximum Daily Mileage | miles | 800 |
| Maximum Weight (GCWR) | lbs | 80,000 |
| Top Speed (0% grade) | mph | 60 |
| Gradeability @0 mph | % grade | 15% at 80,000 lbs |
| Gradeability @40 mph | % grade | 6% at 80,000 lbs (short distance bridge climb) |
| Gradeability @35 mph | % grade | 6% at 57,000 lbs (sustained) |
| # of Shifts between charging/fueling | | 2 shifts with less than 5 hours for charging/ fueling, or 1 shift with diesel-like fueling times |
| <i>Average Operational Assumption for Economic and Infrastructure Analyses</i> | | |
| Average Shift Distance | miles | 160 |
| Average Shift Duration | hours | 9.9 |
| Average Shifts per Day | #/day | 1.6 |
| Average Daily Operating Time | hours | 14.8 |
| Average Daily Mileage | miles | 238 |

Table 17 compares the performance specifications of a typical natural gas drayage truck equipped with a 12-liter engine and a typical battery-electric truck to the basic performance requirements previously described. As shown, both the natural gas and battery-electric platforms are capable of meeting minimum performance specifications.

Table 17: Comparison of basic performance capabilities

| Basic Performance Parameter | Units | Requirement | Typical Natural Gas Semi-tractor | Typical Battery-electric Semi-tractor |
|--|-------|-------------|----------------------------------|---------------------------------------|
| Top Speed | mph | 60+ | ✓ 65 | ✓ 65 |
| Maximum Weight (GCWR) | lbs | 80,000 | ✓ 80,000 | ✓ 105,000 |
| Gradeability @ 0 MPH and 80,000 lbs GCW | % | 15% | ✓ 25% | ✓ 25% |
| Gradeability @ 40 MPH – bridge climb at 80,000 lbs GCW | % | 6% | ✓ >6% | ✓ >6% |
| Gradeability @ 35 MPH – sustained at 57,000 lbs GCW | % | 6% | ✓ 6% | ✓ >6% |

7.5.2. Range (Including Degradation)

Any NZE or ZE architecture must have sufficient range to meet the operational requirements of the trucking industry and should maintain this ability over the life of the truck, that is, should not experience significant degradation that results in performance loss.

2018 Feasibility Assessment for Drayage Trucks –
Section 7: Assessment of Operational Feasibility

Range

Operating range requirements are based on the maximum distance travelled per-shift and per-day. Range for each platform is based on an assumed fuel economy and onboard energy/fuel storage capacity. For the natural gas platform, a 160 DGE CNG fuel system is assumed. CNG fuel tank packages can range in capacity from 60 DGE to over 270 DGE. The 160 DGE system represents a reasonable midpoint configuration that offers sufficient range to meet the range requirements for the BAT specification. Results from the CTP Truck Operator Survey indicated an average diesel fuel economy of 6 miles per gallon and is similar to the 5.8 miles per gallon fuel economy estimated by the Ports in their annual emissions inventories.

Range for the CNG fuel package is based on an assumed fuel economy of 5.1 miles/DGE and was calculated by assuming a 15% fuel economy penalty for natural gas trucks versus a typical diesel truck. This estimate is based on a comparison of recent testing of a 12-liter near-zero natural gas truck⁶⁵ and prior testing of a 12-liter diesel truck⁶⁶ by UC Riverside’s CE-CERT laboratories. The comparison of the test results indicated that the fuel economy of the 12-liter natural gas truck is 10% lower than that of a comparable diesel engine when measured over the Urban Dynamometer Driving Schedule (UDDS) test cycle. However, a comparison of emissions averaged over the three drayage truck test cycles indicated a 20% fuel economy penalty. A 15% fuel economy penalty for natural gas was selected as the midpoint between these two sets of results. It should be noted that CARB and Argonne National Laboratories currently assume a 10% fuel economy penalty for Class 8 CNG semi-tractors in their CA-GREET 3.0 and GREET 2018 models, respectively. Therefore, the 15% fuel economy penalty represents a conservative estimate of the CNG truck’s fuel economy relative to these emissions models. Additionally, the usable capacity of the CNG system was reduced to 87% (139 DGE) of the stated capacity based on manufacturer data sheets and accounts for the gas remaining in the fuel tanks after the fuel system reaches a minimum operating pressure of 290 psig.⁶⁷

The operating range for the electric truck was determined from the manufacturer’s stated battery capacity of 435 kWh⁶⁸ and an energy consumption rate of 2.1 kWh/mile. This energy consumption rate is the average rate reported by CARB in their recent analysis of Energy Economy Ratios (EER) for heavy duty trucks under the LCFS program.⁶⁹ The actual energy consumption rate is dependent on duty cycle; however, the data used by CARB are based on several drayage duty cycles and fall within the range of 2.0 to 2.4 kWh/mile. It is worth noting that the test cycle data used by CARB do not include the effects of heating or air conditioning loads. Nor do the data include other parasitic loads that might be present in some drayage trucks, such as electronic data recorders, telematics systems, or hydraulic pumps. Therefore, the 2.1 kWh/mile energy consumption rate is considered a reasonable but potentially optimistic estimate of the average energy consumption rate that would be seen in a broad deployment of electric trucks. It is noted that the estimated range of 207 miles is significantly greater than the 124 to 167-mile range stated by the manufacturer. The calculated range of 207 miles is used for transparency of assumptions and consistency with drayage-specific duty cycle test results available in literature.

⁶⁵ Johnson, K. and Cavan, G., “Final Report: Ultra-Low NOx Near-Zero Natural Gas Vehicle Evaluation ISX12N 400,” University of California at Riverside, April 2018, https://ucrtoday.ucr.edu/wp-content/uploads/2018/08/CWI-LowNOx-12L-NG_v03.pdf .

⁶⁶ Miller, W. and Johnson, K., “In-Use Emissions Testing and Demonstration of Retrofit Technology for Control of On-Road Heavy-Duty Engines,” South Coast Air Quality Management District, September 2013, https://www.cert.ucr.edu/research/efr/2013_AQMD_in-use_retrofit_Miller.pdf .

⁶⁷ Quantum Fuel Systems product page, <http://www.qtw.com/product/q-cab-cng-fuel-system/>

⁶⁸ BYD 8TT product brochure, http://en.byd.com/usa/wp-content/uploads/2018/07/8tt_redesign6-23-18.pdf

⁶⁹ California Air Resources Board, “Analyses Supporting the Addition or Revision of Energy Economy Ratio Values for the Proposed Low Carbon Fuel Standard Amendments,” Appendix H to the Initial Statement of Reasons, March 2018, <https://www.arb.ca.gov/regact/2018/lcfs18/apph.pdf>

2018 Feasibility Assessment for Drayage Trucks –
Section 7: Assessment of Operational Feasibility

As shown in Table 18, the natural gas truck platform is capable of meeting the maximum shift distance requirement. To meet the maximum daily range requirement, the truck would need to be at least partially fueled or equipped with a larger fuel tank package. Configurations of up to 190 DGE are available and would provide greater than 800 miles of range at the assumed 5.1 mpDGE fuel economy. Typical dispensing rates for CNG stations designed for heavy-duty vehicles are in the 5-10 DGE/minute range, which allows heavy-duty NG trucks to fully refuel in approximately 15-30 minutes.

Table 18: Comparison of vehicle range capabilities

| Operating Range Parameter | Units | Requirement | Typical Natural Gas Semi-tractor | Typical Battery-electric Semi-tractor |
|---|-------|-------------|----------------------------------|---------------------------------------|
| Maximum shift distance (range between fueling/charging) | miles | 600 | ✓ 710 (160 DGE fuel package) | ✗ 207 |
| Maximum Daily Range (with 30 minute refuel/recharge time) | miles | 800 | ✓ 1,420 | ✗ 276 |
| Maximum Daily Range (no refuel/recharge time limit) | miles | 800 | ✓ 1,420 | ✗ 414 |

The battery-electric truck’s maximum shift range of 207 miles is significantly below the 600-mile performance requirement, as is the maximum daily range. Maximum daily range was determined based on a 30-minute fueling/charging window between shifts, where trucks are operated two shifts per day.⁷⁰ If the truck could be fully charged between shifts, the maximum daily range would be twice the maximum shift distance, or 414 miles. While the range capabilities of the current battery-electric truck offering do not meet the BAT specification, they are sufficient to meet the average shift and daily range of drayage trucks. This implies that this truck platform could meet the range requirements for some meaningful fraction of drayage operations, but not all such operations.

Range Degradation

The range values provided in Table 18 are implicitly based on new trucks. As trucks age, their effective range will decrease. In the case of natural gas trucks, range will decrease as its fuel economy decreases due to engine and driveline wear. The degradation in fuel economy of a well-maintained vehicle should be minimal. It is noted that both CARB’s EMFAC model and EPA’s MOVES model do not include any significant deterioration of vehicle efficiency for heavy-duty trucks as the vehicles age. Consequently, it is assumed that the ability of natural gas trucks to meet range requirements will not deteriorate significantly over the vehicle’s life.

Battery-electric truck range degrades as the usable capacity of the battery system degrades over repeated charging cycles. This degradation rate is highly dependent on the battery chemistry, battery system design, depth of discharge, recharging rate, environmental conditions, and duty cycle of the vehicle. These factors make predictions of degradation difficult. Adding to this difficulty, current iterations of battery-electric trucks have only recently begun demonstrations in drayage operations. No trucks have yet accrued sufficient mileage and/or charge cycles to make meaningful estimates of battery degradation based on demonstration data. Electric buses are the most mature heavy-duty electric vehicle segment upon which to draw analogous operational data and it is noted that BYD offers a 12-year battery warranty on its electric buses. Assuming the buses charge once per day, the buses would accrue approximately 3,100 charge cycles over 12 years, similar to a battery-electric drayage

⁷⁰ Manufacturer claimed total recharge time of 1.5 hours using a 300 kW DC fast charger. Assumed 30-minute recharge time provides a 33% state of charge available to use during a second shift.

2018 Feasibility Assessment for Drayage Trucks –
Section 7: Assessment of Operational Feasibility

truck. Batteries are assumed to reach their end of life when they have less than 80% of their original capacity remaining.⁷¹ The assumed 80% end of life capacity is consistent with information presented by BYD regarding the cycle life of their lithium iron phosphate cells at 3,000 to 4,000 cycles.⁷² However, a transition to high nickel content battery chemistries like NMC or NCA to achieve higher driving distances may result in reduced cycle life, at least in the near term as battery chemistries continue to mature.⁷³ Consequently, a battery-electric truck operator should anticipate that the maximum range of the truck could degrade to 80% of its original range over the course of its service life.

7.5.3. Speed and Frequency of Fueling/Charging

Diesel drayage trucks are currently fueled by three methods: 1) fueling at commercial facilities (i.e. truck stops), 2) on-site wet hosing, and 3) on-site fueling stations at motor carrier facilities. The Metro study reported that approximately two thirds of fleets rely on commercial fueling facilities and the remaining third provide fueling on-site.⁷⁴ Additionally, the study noted that baseline diesel trucks are typically refueled every two to four days while LNG trucks typically refuel every day. An increased frequency of fueling generally represents an increased operational burden as it requires additional driver time, wet hosing costs, and/or out-of-route miles for travel to fueling stations.

For the roughly two thirds of fleets that rely on commercial fueling facilities, a fueling/charging frequency of two to four days would be consistent with current diesel practices and should not represent a significant increased operational burden, provided that the fueling stations are within reasonable proximity to drayage operators.

For the remaining one third of fleets that currently fuel trucks at their facilities, a requirement to shift to off-site commercial fueling facilities would represent a change to their operations and could lead to increased operational costs. Fortunately, both battery-electric and natural gas trucks have on-site fueling options. Electric trucks, in particular, are anticipated to rely almost exclusively on on-site charging between shifts and overnight.

Note that, as discussed in Section 4, technologies that did not pass the TRL/Commercial Availability screening were not included in the subsequent analysis of Operational Feasibility, Economic Workability, or Availability of Fuel and Infrastructure. Consequently, hydrogen infrastructure is not discussed in the following sections.

Centralized Fueling/Charging

For the assumed natural gas platform with a 160 DGE fuel system and maximum range of 710 miles, the estimated average daily mileage of 238 miles reported in Table 16 implies a fueling interval of two to three days. This is consistent with current diesel fueling frequencies. The time required for each fueling event is likely to be longer for CNG vehicles than for diesel vehicles. Fueling a 160 DGE CNG system (139 DGE usable) at 10 DGE/minute requires approximately 14 minutes of fill time. By comparison, diesel fuel pumps often operate at 20 to 40 gallons per minute. Providing an equivalent 710 miles of range for a diesel truck would require 118 gallons of diesel fuel that could be delivered in three to six minutes. The additional 8-11 minutes of fueling time required every two to

⁷¹ “Electric Buses in Cities”, Bloomberg New Energy Finance, March 29, 2018, <https://data.bloomberglp.com/bnef/sites/14/2018/05/Electric-Buses-in-Cities-Report-BNEF-C40-Citi.pdf>

⁷² Presentation by BYD, 2016, <https://www.theicct.org/sites/default/files/BYD%20EV%20SEDEMA.pdf>

⁷³ “Electric Buses in Cities”, Bloomberg New Energy Finance, March 29, 2018.

⁷⁴ Papon, A. and Ippoliti, M., “Key Performance Parameters for Drayage Trucks Operating at the Ports of Los Angeles and Long Beach”, CALSTART, November 15, 2013. <http://www.calstart.org/Libraries/l-710-Project/Key-Performance-Parameters-for-Drayage-Trucks-Operating-at-the-Ports-of-Los-Angeles-and-Long-Beach.sflb.ashx>

2018 Feasibility Assessment for Drayage Trucks –
Section 7: Assessment of Operational Feasibility

three days equates to two to five minutes of driver time per day, on average. This impact is assumed to be de minimis with respect to overall daily operations.

The battery-electric truck platform evaluated in this assessment would be recharged approximately once per day, on average. At the manufacturer-specified maximum charging rate of 300 kW, recharging the truck would require 1.5 hours. This represents 15% of the duration of a single shift and is anticipated to represent a significant operational efficiency impact to fleets.

Table 19: Estimated fueling/charging rates required for single-shift and two-shift trucks

| Shifts per Day | Average Daily Range | Typical Natural Gas Semi-tractor | Typical Battery-electric Semi-tractor |
|--|---------------------|----------------------------------|---------------------------------------|
| Single Shift Trucks - Charging/Fueling Rate | 161 miles | 0.9-9.0 SCFM, average 4.3 SCFM | 5-45 kW, 21 kW average |
| Two Shift Trucks - Charging/Fueling Rate | 275 miles | 1.7-107 SCFM, average 32 SCFM | 8-525 kW, 158 kW average |

On-site Fueling/Charging

The possibility of unattended fueling or charging of vehicles eliminates much of the operational burden of extended fueling/charging times for non-diesel vehicles. To allow unattended fueling/charging, the truck must remain parked and connected to the charging/fueling infrastructure for an extended period of time. Trucks operating only one shift per day are expected to have 10 to 14 hours of downtime. These trucks typically also travel fewer miles per day than trucks that operate two shifts per day, reducing the amount of energy that must be transferred during fueling/charging. An analysis of the collected survey data indicates that the combination of extended non-operating time and lower daily mileage for single shift trucks results in modest charging and fueling requirements. As shown in Table 19, single shift electric trucks would require between 5 kW and 45 kW average charging rates, with an average rate of 21 kW across all survey results. These power levels are well within existing power ranges for DC fast chargers that currently operate between 50 kW and 350 kW. Similarly, natural gas fuel flow rates are low, ranging from 0.9 standard cubic feet per minute (SCFM) to 9.0 SCFM per truck, with an average of 4.3 SCFM. Typical natural gas compressors for transportation applications have capacities of 250 to 750 SCFM, allowing a single compressor to potentially support dozens of single-shift trucks in a time-fill application (i.e., overnight fueling).

Trucks operating two shifts exhibit a broader range of charging/fueling rates. Power demand for EV charging could range from 8 kW to 525 kW, and averages 158 kW across all survey responses. DC fast chargers utilizing plug-in charging are not currently available in power levels above approximately 400 kW, although this may change in the near future as the EV industry works towards establishing charging standards with 1,000 V to 1,500 V charging voltages. It should be noted that the 525 kW rate was somewhat of an outlier, with the second highest power demand calculated at 315 kW. Chargers are available at this power level, although they currently require liquid cooled cables and accordingly are more expensive and have a larger installation footprint than non-cooled systems. The fueling rate for natural gas trucks ranged from 1.7 SCFM to 107 SCFM and averaged 32 SCFM. As noted previously, CNG compressors are available in a broad range of flow rates and could support the full range of fueling rates estimated here.

7.5.4. Driver Comfort, Safety, and Fueling Procedures

An operationally feasible technology must provide a similar level of driver comfort and safety as existing diesel trucks. Additionally, fueling procedures must be practical and safe to perform.

Driver Comfort

Driver comfort is a difficult metric to assess as it is highly qualitative and varies for each driver. Ride quality, sound levels, visibility, and various amenities all impact the driver's sense of comfort within a particular truck. Additionally, it must be recognized that the current drayage fleet is comprised of a mix of new and used trucks produced by the major Class 8 truck manufacturers, with a broad range of specifications relating to driver comfort (differing cabin packages, seat designs, axle positions, etc.). To assess a minimum level of driver comfort for the purposes of this feasibility assessment, it is assumed that any truck platform that can be configured similarly to existing diesel trucks would be sufficient.

Natural gas trucks are currently offered by all six major Class 8 truck manufacturers. These natural gas offerings are part of the standard vehicle specification and ordering process and can be equipped with a broad range of equipment options. They are also available on a number of standard chassis. Consequently, natural gas trucks are assumed to meet the minimum threshold for driver comfort. It is also noted that natural gas trucks are generally quieter than diesel trucks and offer potentially superior driver comfort for an otherwise equivalently specified truck.

The current battery-electric truck offering is a cab-over design that differs from the typical "conventional cab" or "aero cab" designs prevalent in the drayage fleet today. The cab-over design can offer increased visibility and improved low-speed maneuverability relative to conventional cabs, providing a degree of improved driver comfort in some applications. However, broad driver acceptance of the cab-over design remains to be proven owing to the limited number of drayage trucks with this design currently in operation. Ongoing demonstrations of this platform are expected to provide greater clarity regarding driver acceptance of this vehicle's design. Future battery-electric truck designs announced by Tesla, Daimler, and Volvo are based on aero cab designs and will likely meet the minimum standard for driver comfort in this feasibility assessment. It should also be noted that battery-electric trucks, in particular, exhibit very low noise levels and reduced vibration that are routinely noted by drivers as positive aspects of this technology. These characteristics can lead to reductions in driver fatigue and significant improvements in overall driver comfort as compared to the typical diesel truck.

Safety

Heavy-duty vehicle safety in the U.S. is largely regulated under Federal Motor Vehicle Safety Standards (FMVSS) implemented by the National Highway Traffic Safety Administration (NHTSA). The FMVSS covers a broad range of requirements for vehicle design, construction, and operation. Heavy-duty vehicle manufacturers are required to certify that their vehicles are compliant with FMVSS before offering the vehicles for sale. Unlike light duty vehicles, heavy duty vehicles do not have crash test ratings issued by NHTSA. Rather, NHTSA conducts studies of real-world crashes and incorporates that information into future proposed modifications to the FMVSS. Consequently, heavy-duty truck manufacturer certifications of compliance with FMVSS requirements are used as the minimum threshold for assessing basic vehicle design safety for purposes of this assessment. Because these certifications are required for vehicle sales in the U.S., it is assumed that all commercially available vehicles meet the minimum safety requirements for this assessment.

There are often additional safety concerns raised with respect to the use of natural gas or batteries in a heavy-duty vehicle. While these concerns are reasonable to raise, it must be recognized that tens of thousands of heavy-

2018 Feasibility Assessment for Drayage Trucks –
Section 7: Assessment of Operational Feasibility

duty natural gas vehicles (both CNG and LNG) have been deployed in the U.S. The current body of literature does not support the idea that these vehicles pose a higher risk relative to diesel vehicles. Similarly, almost 750,000 light-duty EVs had been deployed in the U.S. through 2017⁷⁵ and 285 heavy-duty transit vehicles were in operation in 2017.⁷⁶ Despite the higher energy levels stored in heavy-duty vehicle batteries as compared to light duty vehicles, current demonstrations and data do not provide evidence of higher risks relative to diesel vehicles.

Fueling/Charging Procedures

Fueling of heavy-duty CNG trucks, as well as charging of heavy-duty battery-electric trucks, are straightforward practices that require minimal driver/refueler training. An exception is noted with regard to high-power overhead charging of electric vehicles, as is seen in some transit bus applications. Overhead charging requires additional driver training to properly align the vehicle with the overhead charging system and to follow the appropriate procedures to initiate the charge. However, no electric drayage truck is currently being equipped for this type of charging interface. It seems likely that high-power overhead charging will be confined to transit applications for the next several years. It is possible that future assessments will need to revisit this issue.

Neither type of infrastructure (CNG or battery-electric) requires personnel to wear protective clothing/equipment during the fueling/charging process. Consequently, it appears that neither fuel-technology platform imposes a significant incremental operational burden on end users, relative to current diesel fueling procedures.

7.5.1. Truck Weight Impacts

Both natural gas and battery-electric trucks are typically heavier than a comparable diesel truck. As shown in Table 20, a typical day cab diesel truck is estimated to weigh 18,100 lbs when fully fueled with 130 gallons of diesel fuel.⁷⁷ A comparable natural gas truck would weigh approximately 20,000 lbs.⁷⁸ The listed curb weight for BYD's current battery-electric truck is 25,353 lbs, representing an incremental weight of 7,200 lbs over a typical diesel truck.

Estimating the weight of a battery-electric truck that meets the BATS standard for range is difficult, because no Class 8 truck has yet been produced commercially that is equipped with the required battery capacity. Tesla's Semi with a rated range of 500 miles comes close to the BAT specification but Tesla does not publish the estimated curb weight of the truck. In their report, NACFE estimates that the powertrain of a Class 8 diesel truck weighs approximately 6,100 lbs, excluding fuel. Deducting this weight from the baseline diesel truck weight of 17,000 lbs implies a base chassis weight of 10,900 lbs for an electric truck. The battery weight is estimated for a 1,260 kWh battery pack and an energy density of 72.5 Wh/lb.⁷⁹ An estimated 2,000 lbs of additional weight is assumed to account for traction motors, power electronics, cooling systems, and other associated equipment; resulting in a projected curb weight of 30,300 lbs for a BATS-compliant battery-electric truck. It is noted that these are very rough estimates and that extensive lightweighting of the chassis, as is being claimed by Tesla, could reduce the curb weight of a BATS-compliant truck below the estimate shown here. However, it could also increase costs.

⁷⁵ Lutsey, N., "California's continued electric vehicle market development" International Council on Clean Transportation, The International Council on Clean Transportation, May 2018, <https://www.theicct.org/sites/default/files/publications/CA-cityEV-Briefing-20180507.pdf>

⁷⁶ Federal Transit Administration, "2017 Annual Database Revenue Vehicle Inventory," 2018, <https://www.transit.dot.gov/ntd/data-product/2017-annual-database-revenue-vehicle-inventory>

⁷⁷ Based on typical drayage truck specifications provided by Vehicle Velocity Group. 130 diesel gallons provides an equivalent range as a 160 DGE CNG fuel system.

⁷⁸ Based on Quantum Q-Cab 160 DGE CNG fuel system. <http://www.qtw.com/product/q-cab-cng-fuel-system/>.

⁷⁹ Approximate energy density of Proterra E2 and Tesla Model 3 battery packs

2018 Feasibility Assessment for Drayage Trucks –
Section 7: Assessment of Operational Feasibility

Table 20. Estimated truck curb weights

| Technology | Diesel | CNG | Current BEV | BATS BEV |
|------------------------------|--------|--------|-------------|----------|
| Base Truck | 17,000 | 17,000 | 25,353 | 10,900 |
| Fuel System and Fuel | 919 | 3,067 | included | 19,400 |
| DEF | 209 | 0 | 0 | 0 |
| Total Curb Weight | 18,128 | 20,067 | 25,353 | 30,300 |
| Incremental Weight vs Diesel | - | 1,939 | 7,225 | 12,172 |

As a truck’s curb weight⁸⁰ increases, the payload carried by the truck may need to be reduced to remain within weight limits. The blue line in Figure 10 depicts the maximum payload capacity (weight of the trailer and cargo) that could be carried by a standard five-axle semi-tractor that is subject to California bridge weight limits.⁸¹ As the curb weight of the tractor increases, the maximum potential payload decreases at a rate of 2:1. That is, for every one pound increase in the weight of the tractor, the maximum payload capacity decreases by two pounds. The vertical lines on the figure indicate the curb weight of the diesel, CNG, and battery-electric trucks shown in Figure 10 and their intersection with the blue cargo capacity line indicates their maximum cargo capacity at their assumed curb weight. Assuming the average weight of a container chassis is 7,000 lbs, a typical diesel truck could transport a container weighing up to 49,000 lbs (56,000 lbs total cargo capacity – 7,000 lbs trailer weight). An equivalent CNG truck would be limited to a maximum container weight of 47,000 lbs while a battery-electric truck would be limited to a 35,000 lbs container weight. A BAT-compliant battery-electric truck would be limited to a container weight of 24,400 lbs.

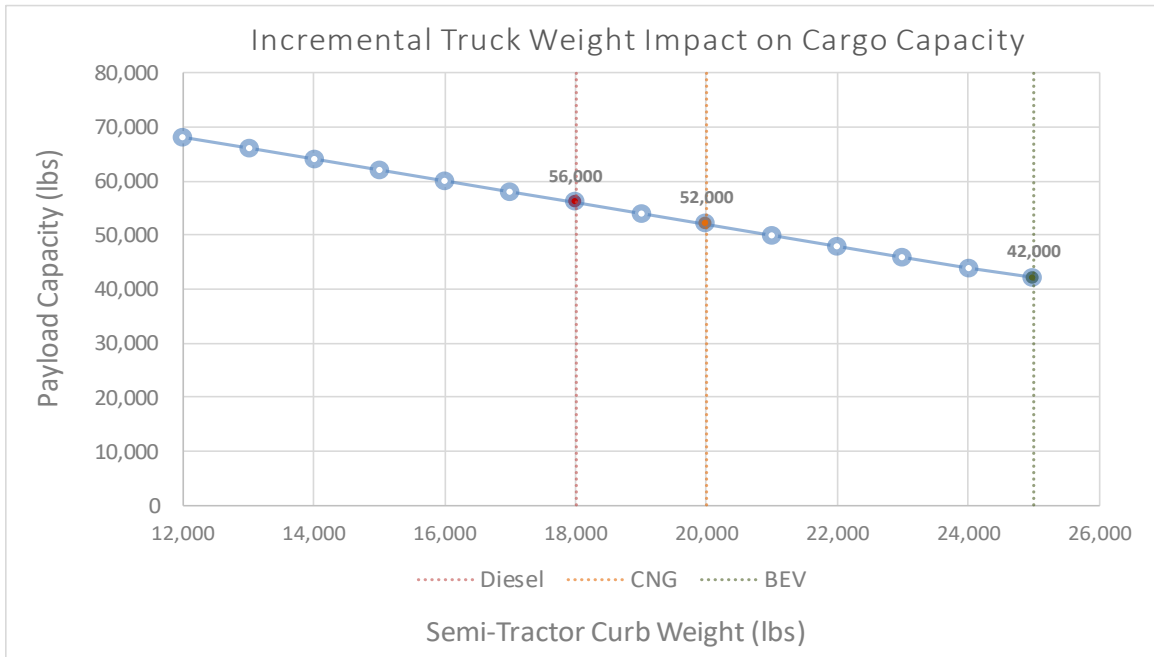

Figure 10. Incremental truck weight impacts on cargo capacity

⁸⁰ The curb weight is the weight of the vehicle without occupants or cargo.

⁸¹ These weight limits are typically 12,000 lbs for a front single axle, and 34,000 lbs for each of the tandem axles on the tractor and trailer. This results in a maximum allowed vehicle weight of 80,000 lbs.

2018 Feasibility Assessment for Drayage Trucks –
Section 7: Assessment of Operational Feasibility

For the 57,000 lbs average GCW discussed in Section 7.4, an 18,000 lbs diesel truck would carry a 32,000 lbs load. This is within the estimated cargo capacity for the current battery-electric truck. For a BAT-compliant truck, the 32,000 lbs cargo would exceed the carrying capacity of the truck. To carry this load, a BAT truck would be restricted to overweight corridors, require the use of tridem or spread trailer axles, or utilize full trailers rather than semi-trailers. While technically possible, these options all create operational inefficiencies relative to diesel carrying these average loads.

A significant portion of respondents to the Drayage Operator Survey indicated maximum operating weights of 70,000 to 80,000 lbs, implying a maximum cargo weight of 52,000 to 62,000 lbs. The heaviest loads, at or near 80,000 lbs, are typically bulk haulers rather than those transporting shipping containers. For these operators, incremental weight of the truck creates an equivalent loss in cargo capacity. For example, a natural gas truck with a 2,000 lbs incremental weight would reduce the truck operator's cargo capacity by 2,000 lbs.

For truck operators using a typical 5-axle semi-tractor/trailer combination, the natural gas truck's additional 2,000 lbs of tractor weight does reduce the maximum cargo capacity to 52,000 lbs and would imply a diesel equivalent GCW of 70,000 lbs. Trucks operating over 70,000 lbs GCW on a typical five-axle tractor/trailer would likely face operational challenges with a typical natural gas truck. Lightweighting and careful sizing of the fuel system to reduce incremental weight could reduce this weight penalty. For example, specifying a 123 DGE CNG system would reduce the truck's weight by 600 lbs.

AB-2061 was recently passed that allows near-zero and zero-emission trucks to exceed weight limits on the tractor by up to 2,000 lbs and may operate at up to 82,000 lbs GCW.⁸² Because the language of the bill allows both the GCW of the tractor/trailer and the weight limits on the tractor itself to increase by 2,000 lbs, this change effectively eliminates the typical weight penalty for near-zero natural gas trucks. It also reduces the effective weight penalty of the battery-electric truck by 2,000 lbs, allowing the truck to haul up to 40,000 lbs containers. This increase allows the battery-electric truck to transport many of the containers moved through the ports. However, maximum loading of shipping containers can easily exceed 40,000 lbs. For example, OOCL recommends a 39,500 lbs maximum container weight for dry 20-foot containers, but up to 44,500 lbs for dry 40-foot containers.⁸³ Consequently, it is assumed that current battery-electric trucks would be unable to legally transport many of the 40-45-foot shipping containers moving through the Ports. A BATS-compliant battery-electric truck would be limited to approximately 28,400 lbs containers, making it unsuitable for much of the cargo transported in the Ports.

7.5.2. Availability of Replacement Parts and Support for Maintenance / Training

Maintenance and repair of alternative fuel heavy-duty trucks can be subdivided into three broad categories of activity: preventative maintenance, repair of standard systems, and repair of alternative fuel systems. Preventative maintenance activities include vehicle inspections, fluids and filter changes, tire and brake system maintenance, etc. Preventative maintenance may be performed by the truck owner, a leasing company, or a local maintenance facility.

Repairs of standard systems refers to maintenance and repair of systems on the vehicle that are typically present on diesel vehicles. Examples include suspension systems, air or hydraulic lines, and low voltage electrical systems.

⁸² "AB-2061 Near-zero-emission and zero-emission vehicles", California Legislative Information, https://leginfo.ca.gov/faces/billCompareClient.xhtml?bill_id=201720180AB2061

⁸³ "Operational Restrictions," OOCL, <https://www.oocl.com/usa/eng/localinformation/operationalrestrictions/Pages/default.aspx>

2018 Feasibility Assessment for Drayage Trucks –
Section 7: Assessment of Operational Feasibility

This category specifically excludes high voltage systems and power electronics in electric vehicles and high-pressure fuel systems in CNG vehicles.

Repairs of alternative fuel systems refers to the specialized systems specific to alternative fuels that require special training, tools, and facilities to repair.

Natural Gas Vehicles

Heavy-duty natural gas vehicles in Southern California are currently supported by several large truck dealership networks including Vehicle Velocity Group (Daimler/Freightliner), Inland Kenworth, Rush Trucks (Peterbilt), and TEC (Volvo). Additionally, Cummins Pacific has two facilities in Southern California providing engine OEM support for the only heavy-duty natural gas engine currently available for Class 8 trucks. Finally, these trucks can also be serviced by a number of truck leasing companies and third-party maintenance providers. This substantial network of service providers is composed of many of the same companies that provide service and parts for the Class 8 diesel market in Southern California. These companies are capable of performing all necessary maintenance and repair of heavy-duty natural gas trucks.

Vehicle owners can perform basic preventative maintenance work on natural gas vehicles, following Cummins-provided preventative maintenance schedules. Additionally, Cummins offers parts and maintenance information through its standard QuickServe system. Specialized maintenance facilities are not required to perform preventative maintenance or repairs provided those repairs do not require disturbing the natural gas fuel system.

Repair of natural gas-specific systems requires specialized training and appropriately equipped maintenance facilities. As noted in the Metro study, only the largest fleets generally own and operate their own maintenance facilities. The majority of fleets are expected to have any such services, and major repairs in general, performed by third party service centers such as the vehicle and engine dealerships previously noted.

Battery-Electric Vehicles

As heavy-duty battery-electric drayage trucks are currently in demonstration and the number of deployed trucks remains small, most service and maintenance beyond basic preventative maintenance is provided by the truck manufacturer. BYD provides up to 40 hours of driver and preventative maintenance training to fleets purchasing their vehicles. Additionally, BYD’s electric bus and truck manufacturing facility is located in Lancaster, CA, offering a local source of support for parts and technicians to repair their vehicles. It appears that BYD has the necessary elements to support a maintenance and repair supply chain for heavy-duty trucks in Southern California, but this supply chain will not be tested until additional heavy-duty trucks are deployed into regular service. Looking ahead, battery-electric trucks in development from Daimler and Volvo would be able to take advantage of these companies’ well-established maintenance ecosystems once these platforms are commercialized.

7.6. Summary of Findings for Operational Feasibility

Table 21 summarizes the specific criteria and base requirements (outlined above) applied in this Feasibility Assessment to collectively establish whether the two fully screened ZE or NZE drayage truck platforms are “operationally feasible” today. In the final column of the table, snapshot ratings are provided of the degree to which these platforms already meet these basic considerations today, or are at least showing measurable progress towards achieving commercial status by the end of 2021.

Following the table, we provide further discussion about the rationale for the ratings provided in the table, and the broad implications to the overall 2018 Drayage Truck Feasibility Assessment.

2018 Feasibility Assessment for Drayage Trucks –
Section 7: Assessment of Operational Feasibility

Table 21. Summary of ratings by key criteria: 2018 Operational Feasibility

| Operational Feasibility Criteria / Parameter | Base Considerations for Drayage Platforms to Achieve Operational Feasibility | Achievement of Criteria in 2018 for Commercially Available Drayage Truck Platforms | |
|---|--|--|------------|
| | | ZE Battery-Electric | NZE NG ICE |
| Basic Performance | Demonstrated capability to meet drayage company needs for basic performance parameters including power, torque, gradeability, operation of accessories, etc. | | |
| Range | Demonstrated capability to achieve per-shift and daily range requirements found in San Pedro Bay drayage. | | |
| Speed and Frequency of Refueling / Recharging | Demonstrated capability to meet drayage company needs for speed and frequency to refuel / recharge such that revenue operation is not significantly reduced relative to diesel baseline. | | |
| Driver Comfort, Safety, and Refueling Logistics | Proven ability to satisfy typical drayage trucking company's needs for comfort, safety and refueling procedures. | | |
| Availability of Replacement Parts and Support for Maintenance / Training | Verifiable existence of and timely access (equivalent to baseline diesel) to all replacement parts needed to conduct scheduled and unscheduled maintenance procedures. | | |
| | Verifiable existence of maintenance procedure guidelines and manuals, including OEM-provided training courses upon purchase and deployment of new trucks. | | |
| Legend: Operational Feasibility (2018) | | | |
| Source: Based on Drayage Truck Operator Survey responses, footnoted studies, OEM product information, and consultant's industry knowledge. | | | |

NZE Natural Gas ICE - Among the five core fuel-technology platforms, drayage trucks powered by natural gas ICE technology are farthest along the path of “operational feasibility.” The 12-liter CWI natural gas engine (standard version) has already been proven capable of providing near-diesel-equivalent performance and range in all three general types of drayage trucking. While the NZE version of this same 12-liter CWI engine has only been deployed in approximately 20 in-use drayage trucks to date, there is no apparent reason to believe that the NZE version will not also provide near-diesel-equivalent overall performance and operational feasibility.

Natural gas trucks currently offer the only alternative technology that can achieve the daily range requirements and fueling intervals expected by drayage operators. Fueling times are somewhat extended relative to diesel in a fast-fill scenario but are expected to be reasonable for the average drayage truck that would refuel every two to three days.

Driver comfort and safety are expected to be equivalent to diesel trucks as natural gas variants are available in many of the same models as diesel trucks and available with a broad range of equipment options. Fueling procedures are straightforward and should not pose a barrier to adoption.

Drayage trucks equipped with this engine are fully supported by OEMs for the key provisions identified in the table (warranty, parts, maintenance, training, etc.) and several major dealerships and service networks exist in the

2018 Feasibility Assessment for Drayage Trucks –
Section 7: Assessment of Operational Feasibility

region capable of servicing these trucks and/or expanded to service the fleet as additional natural gas trucks are deployed.

ZE Battery-Electric -While several truck manufacturers are currently developing Class 8 battery-electric trucks and anticipate bringing them to market in the 2021 timeframe, the battery-electric trucks currently available are suitable for niche operations within drayage but are not considered broadly applicable. Battery-electric trucks generally outperform diesel trucks with respect to power, torque, and gradeability. However, range, weight, and recharging time remain barriers that restrict the applicability of these trucks.

Driver comfort and safety are not expected to pose major barriers to adoption. Currently available trucks employ a cab-over design that was commonly seen in trucks in the U.S. in the 1970s and 1980s and were found in use as drayage trucks until the implementation of the first CAAP in 2008 barred the use of these older trucks. Battery-electric trucks under development are based on conventional cab designs and will more closely resemble the typical drayage truck in use today. Recharging procedures are simple and not expected to pose a barrier to adoption.

Current battery-electric drayage trucks are supported by a single OEM. While that manufacturer appears to have the service supply chain components needed to support significant additional deployments of trucks, the service network will need to grow or additional truck OEMs will need to enter the market to create confidence in the capacity of that network to quickly service and repair trucks.

8. Assessment of Infrastructure Availability

8.1. Criteria and Methodology

Availability of suitable fueling Infrastructure is essential for the Ports to transition to near-zero- and zero- emission fuel-technology platforms within the timeframes prescribed by the CAAP. Regardless of the energy form utilized (e.g., natural gas, propane, hydrogen and/or electricity), fleets that deploy ZE and NZE drayage truck platforms will require convenient and safe access to affordable fuel.

Note that for the purposes of this feasibility assessment, “infrastructure” includes the fuel dispenser/charger as well as the other equipment and site improvements needed to supply the dispenser. Examples of infrastructure components include compression systems, transformers, switch gear, conduit, piping, and the associated site work needed to install this equipment.

The key criteria and base considerations that were collectively used to assess Infrastructure Availability are listed in Table 22 below.

Table 22: Criteria for establishing Infrastructure Availability for emerging drayage truck platforms

| Infrastructure Criteria / Parameter | Base Considerations for Assessing Infrastructure Availability |
|---|--|
| Dwell Time at Station | Fueling/charging can be accommodated within typical work breaks, lunches, other downtime compatible with trucking company schedules and operational needs. |
| Station Location and Footprint | Fleets have existing onsite access to fueling infrastructure, or can be fueled/charged conveniently and affordably off site, at public or private stations. New infrastructure can be installed without extensive redesign, reconfiguration or operational disruptions and there is sufficient electrical or natural gas capacity at the site. |
| Infrastructure Buildout | Infrastructure can be constructed at a pace consistent with fleet adoption and able to meet fleet fueling/charging requirements by the end of the assessment period. |
| Existence of / Compatibility with Standards | A sufficient body of codes and standards exist from appropriate organizations that enables safe and effective fueling/charging. The fueling/charging station technology has already been installed at other trucking companies in the U.S., with sufficient time to assess performance and safety. |
| Source: Based on criteria in San Pedro Bay Ports’ “Framework for Developing Feasibility Assessments”, November 2017. | |

8.2. Important Considerations Associated with the Baseline Diesel Infrastructure and Fleet

8.2.1. Number of Stations and Convenience of Location

The existing network of diesel stations presents a very high bar for any alternative fuel platform to replicate. There are roughly 2,500 retail diesel stations located within a typical drayage haul of the two Ports.⁸⁴ As further described, neither natural gas fueling nor electric charging stations come close to this level of build-out in terms of station number and strategic location.

⁸⁴ The California Energy Commission reports that there are 4,854 retail diesel stations in California (https://www.energy.ca.gov/almanac/transportation_data/gasoline/piira_retail_survey.html). Roughly ½ are located in Southern California. Los Angeles County alone has more than 1,000 diesel stations.

2018 Feasibility Assessment for Drayage Trucks –
Section 8: Assessment of Infrastructure Availability

Given the relative paucity of these types of fueling/charging stations, major station build-outs will be needed if large numbers of battery-electric and/or natural gas drayage trucks are to be rapidly deployed over the next several years. The pace of the build-out will need to be commensurate with the numbers of tractors deployed for each type. The new stations will either be dedicated facilities in the yards of trucking companies, or retail stations. In either case, they will need to be installed relatively rapidly, with a clear return on investment for the entities that build them (taking into account any available government incentives). And, as described in the next section, it will be very important that this station build-out aligns with the scope and scale of the San Pedro Bay Ports' fleet and the relative percentage of trucks using battery-electric and natural gas ICE powertrains.

8.2.2. Infrastructure Implications of Common Truck Parking Procedures

Drayage trucks may park overnight at a motor carrier's facility or parked at various parking lots throughout the region. At motor carrier facilities, parking space is often limited and the site layout may create significantly congested parking that creates challenges for siting charging or fueling infrastructure (see Figure 11). Off-site parking locations can include the truck owner's private residence, street parking, or rented space at other commercial properties not engaged in trucking. Trucks that are parked at locations other than motor carrier facilities are anticipated to be impractical to serve with fueling/charging infrastructure at the parking location.



Figure 11. Examples of truck parking at motor carriers

An analysis of responses to the Drayage Truck Operator survey indicated that approximately 72% of trucks park overnight at a motor carrier facility. This is slightly lower than the estimate of 80-90% of trucks returning to their yard at the end of the day reported in the Metro study. Because of the previously noted challenges with providing on-site charging/fueling for trucks that do not park at motor carrier facilities, it is assumed that these trucks must be served by fast charging/fueling facilities in a manner similar to existing diesel fuel stations. Such stations could potentially be located at a motor carrier's facility or at public access fueling stations.

8.3. Application of Criteria to Natural Gas Fueling Infrastructure

CNG fueling infrastructure can be configured for time-fill or fast-fill fueling rates. Public access fueling stations are configured for fast-fill dispensing, similar to diesel fuel stations, with dispensing rates of 10 DGE/minute being readily achievable. Private stations may be configured as either time-fill or fast-fill, depending on the fleet and site requirements. In a time-fill configuration, multiple trucks are connected to a single fuel compressor and filled slowly over the course of several hours. In this configuration, CNG fueling is analogous to overnight charging of EVs. Time-fill solutions are generally a less expensive fueling strategy for fleets than fast-fill stations because the slower fill rate over a longer period of time allows for the use of smaller compressors and reduced station energy consumption. Time-fill stations may also be equipped with a priority hose that allows the full output of the

2018 Feasibility Assessment for Drayage Trucks –
Section 8: Assessment of Infrastructure Availability

compressors to be directed to a single hose. In this use case, fueling for other trucks is suspended while the priority hose acts as a fast-fill dispenser.

8.3.1. Station Location and Footprint

An estimate of the fraction of trucks that could be served by on-site fueling infrastructure was made using rough estimates of the typical footprint of a CNG compression system. For each response to the Drayage Truck Operator survey, an estimate of the average fuel flow rate was determined based on the average daily mileage and number of shifts reported. These flow rates were translated into space requirements based on an assumed footprint of 16 feet by 50 feet for an 800 SCFM CNG compression system. The resulting space requirement was then compared to the respondent’s estimated available space for fueling infrastructure. Many respondents indicated that less than 500 square feet was available for fueling infrastructure (the lowest option offered in the survey) and are assumed to be too space constrained to accommodate fueling infrastructure on-site. The results of this analysis indicate that approximately 58% of trucks that park on-site could be fueled with CNG on-site. Combining this result with the estimated 72% of all surveyed trucks that park on-site implies that approximately 42% of the fleet could be served by on-site fueling.

It must be noted that these are very rough estimates and that each site’s conditions are unique. Conditions that affect viability of fueling infrastructure include availability and capacity of utility supplies, facility layout and traffic patterns, property setback requirements, overhead power lines, and other issues. The true potential for on-site fueling could be greater or less than the estimate made here.

Assuming that 42% of trucks could be fueled on-site, the remaining 58% of trucks would require public access fast-fill stations. Table 23 summarizes the implied fuel throughput of the on-site and public stations that would be required for an 11,000-truck and an 18,000-truck drayage fleet.

Table 23. CNG Fueling Infrastructure- Required Throughput Estimates

| Fueling Location | 11,000 Truck Fleet | 18,000 Truck Fleet |
|---|--------------------|--------------------|
| On-site Stations | | |
| <i>Trucks Served</i> | 4,620 | 7,560 |
| <i>Daily Fuel Throughput</i> | 215,600 DGE | 352,800 DGE |
| Public Stations | | |
| <i>Trucks Served</i> | 6,380 | 10,440 |
| <i>Daily Fuel Throughput</i> | 297,700 DGE | 487,200 DGE |
| <i>Total Daily Fuel Throughput</i> | 513,000 DGE | 840,000 DGE |

8.3.2. Infrastructure Buildout

The range of daily fuel throughput for the public stations is estimated at 297,700 to 487,200 DGE. As a point of comparison, Clean Energy’s existing LNG and CNG (LCNG) fueling station at 3400 E I St in Wilmington is currently equipped with 50,000 gallons of LNG (23,400 DGE) fuel storage but can be expanded to 100,000 LNG gallons (35,200 DGE) and can be expanded from the current six fueling lanes to ten lanes. This site can dispense LNG to a truck as either LNG or CNG (LCNG station). Assuming one full turnover of the LNG storage tanks per day, it would require between 9 and 14 similar stations to meet the estimated public fueling demand. To build this out by 2021, this would imply a construction rate of 3-5 large public access stations per year. Additionally, CNG stations supplied by utility pipeline could be constructed in lieu of LCNG stations or as complements to LCNG station development.

2018 Feasibility Assessment for Drayage Trucks –
Section 8: Assessment of Infrastructure Availability

There are currently 12 LNG fueling stations and 57 CNG fueling stations within the Southern California region.⁸⁵ The combined spare capacity of these stations has not been analyzed, but it is expected that substantial unused CNG and LNG dispensing capacity is available to support initial growth of a natural gas drayage fleet. The estimated total fleet need for 9 to 14 large LCNG stations or an equivalent combination of LCNG and pipeline CNG stations is not unreasonable. Further, if fleets do not construct on-site fueling at the rate needed to support 42% of trucks, additional public fueling stations would be required. It is anticipated that fuel suppliers would step in to construct this level of fueling infrastructure if there is clear demand in the market. However, this scale of geographically concentrated natural gas fueling infrastructure development (over 500,000 DGE per day of fueling capacity) over a three-year timeframe has not been achieved anywhere in the U.S. While station design and construction for a single station could be completed in a six to twelve-month timeframe, numerous factors may extend station construction timelines. These factors include site selection, permitting challenges, utility improvements, and equipment lead times. A credible plan for how to manage these challenges and deliver sufficient fueling infrastructure for the entire drayage fleet over a three-year period has not yet been put forward by the natural gas industry, leaving the ability of the industry to deliver on these needs uncertain. That said, Clean Energy notes that it was able to construct 70 LNG stations in a 12-month period as part of its America's Natural Gas Highway program and firmly believes that industry would be able to develop sufficient infrastructure in the three-year period considered in this Assessment.

8.3.3. Codes and Standards

Compressed natural gas vehicles are regulated by well-defined codes and standards that define tank pressures, connector types, and safety systems. All modern heavy-duty trucks and CNG fueling stations in the U.S. are built to these standards, allowing for essentially universal interoperability between fueling stations and trucks. Older stations may be equipped with lower flow nozzles (NGV-1) rather than the heavy-duty nozzles (NGV-2) that are provided with modern heavy-duty stations. Additionally, some older stations offer 3,000 psi fueling pressures, rather than the industry standard of 3,600 psi. This does not necessarily prevent a new truck from fueling at an older station, but the truck may experience partial fills and/or extended fueling times. For the purposes of this analysis, it is assumed that all new fueling infrastructure would be developed with the intent to supply heavy-duty trucks and would therefore support high flow nozzles and 3,600 psi nominal fueling pressures, as is the current industry standard practice.

It is also important to note that, while codes and standards exist for natural gas fueling infrastructure, the permitting requirements imposed by local authorities can create significant barriers to infrastructure development. These requirements vary by jurisdiction and permitting entity. Where a local authority is unfamiliar with natural gas fueling stations, time may be required to educate the local authority regarding the appropriate codes and standards of practice before a permit can be secured. Additionally, local authorities may require that some equipment be listed by a particular listing entity while the equipment is listed by an alternative agency. Listing equipment with a new agency is a time consuming and costly process that can significantly delay or terminate a project.

These are only some of the potential barriers that may be encountered in the permitting process. Many municipalities now have examples of operational natural gas fueling stations in their jurisdiction and this facilitates permitting of additional stations. However, projects that have unique attributes (portable/temporary stations, proximity to certain activities/facilities, etc) can face unique permitting challenges that extend timelines and add costs.

⁸⁵ Alternative Fuels Data Center Station Locator, <http://www.afdc.energy.gov/stations>

8.4. Application of Criteria to Battery-Electric Charging Infrastructure

Charging infrastructure can be designed to recharge vehicles at a wide range of power levels, ranging from a few kilowatts to several megawatts. The vehicle design limits the maximum charging rate, while operational requirements determine the minimum acceptable charging rate. The currently available Class 8 semi-tractor considered in this assessment has a maximum charging rate of 300 kW, allowing the truck to be recharged in as little as 1.5 hours. However, high charging rates generally incur higher utility costs, require costlier infrastructure, and accelerate deterioration of the vehicle batteries. Where possible, it is preferred to charge a vehicle at the lowest rate that meets the operational requirements of the fleet.

8.4.1. Station Location and Footprint

Similar to the process described in section 8.3.1, an estimate of the number of trucks that could be served by on-site charging infrastructure was developed based on responses to the Drayage Truck Operator survey and assumptions about the typical footprint of charging infrastructure. For each response to the Drayage Truck Operator survey, an estimate of the required minimum average charging rate was determined based on the average daily mileage and number of shifts reported. These charging rates were translated into space requirements based on an assumed footprint of 7.5 kW per square foot. This footprint is primarily based on the footprint of a DC fast charging power cabinet in the 50 kW to 200 kW power range. It does not include the footprint of dispensers, switchgear, or utility transformers. Many of these additional pieces of equipment serve several power cabinets, potentially making their relative contribution less significant than the power cabinets. Note, however, that when very high power levels and/or high utility supply voltages are utilized, the footprint of the supporting equipment can become significant. The results of this analysis indicate that approximately 58% of trucks that park on-site could be served by on-site charging infrastructure. Combining this result with the estimated 72% of trucks that park on-site implies that approximately 42% of the fleet could be served by on-site charging.

As with the CNG analysis, these are very rough estimates that cannot account for individual site conditions. For example, many trucking sites have limited access to electrical power, and would need to work with their local utility (Southern California Edison or the Los Angeles Department of Water & Power) to make significant infrastructure and costly changes. Consequently, the practicable potential for on-site charging could be greater or less than the calculated estimate.

Assuming that 42% of trucks could be charged on-site, the remaining 58% of trucks would require public access fast-charging stations. At this time, there are no demonstrated public access heavy-duty charging stations in the U.S. While there is no fundamental technical barrier to creating these facilities, there are significant operational and cost challenges for fleets and facility operators that currently make such infrastructure infeasible. For example, dwell times at a public access charging station will be lengthy. As discussed in Section 7.5.3, charging times could exceed 1.5 hours. Making a rough assumption that the majority of trucks would seek to charge in a four-hour window before or after a shift, this would imply a total charging time of 8 hours per day for the majority of public access charging stations. For a fleet of 11,000 to 18,000 trucks, with 58% of that fleet relying on public charging, space could be required for 1,200 to 2,000 trucks charging simultaneously. As a rough approximation, a typical diesel truck stop was considered and found to have ten fueling lanes and occupy 60,000 square feet for the fueling lanes and support buildings. This implies a ratio of approximately 6,000 square feet per fueling lane and allows for the turning areas required for a semi-tractor with a connected trailer. At 6,000 square feet of land per fueling lane, providing charging for 1,200 to 2,000 trucks simultaneously would require 180 to 300 acres of land. Space requirements could be greater or less than this rough estimate, but until large public access charging stations for heavy duty trucks are demonstrated, it is not possible to accurately gauge the true space

2018 Feasibility Assessment for Drayage Trucks –
Section 8: Assessment of Infrastructure Availability

requirements. At a minimum, the space requirements will be significant and have yet to be identified, making the construction of sufficient public access charging infrastructure to serve the drayage fleet over the next three years effectively impossible.

Table 24 summarizes the implied energy throughput of the on-site and public stations that would be required for an 11,000-truck and an 18,000-truck drayage fleet. Note that these calculations reflect the 2.1 kWh/mile assumed energy consumption rate of the truck and an 85% wall outlet-to-wheels efficiency.⁸⁶

Table 24. EV Charging Infrastructure- Required Throughput Estimates

| Fueling Station Type / Location | 11,000 Truck Fleet | 18,000 Truck Fleet |
|--------------------------------------|--------------------|--------------------|
| On-site Stations | | |
| Trucks Served | 4,620 | 7,560 |
| Daily Energy Throughput | 2.75 GWh | 4.50 GWh |
| Public Stations | | |
| Trucks Served | 6,380 | 6.21 GWh |
| Daily Energy Throughput | 3.80 GWh | 487,200 DGE |
| Total Daily Energy Throughput | 6.55 GWh | 10.7 GWh |

8.4.2. Infrastructure Buildout

Much of the daily energy requirements for the drayage fleet would be supplied overnight, with some trucks operating only single shifts and having as much as 14-16 hours available for charging. Based on the weighted average charging rates required for the fleet, it is estimated that total power demand could peak at 1.0 GW for an 11,000-truck fleet and 1.7 GW for an 18,000-truck fleet. While this is clearly a substantial new electrical load, it only represents about 3% to 6% of the combined peak load of 30 GW in the LADWP and SCE territories (see Table 25). Additionally, because this load is likely to occur predominantly during off-peak periods, EV charging can serve to level the overall demand curves for each utility and potentially reduce costs across the system. Despite these benefits and the relatively small increase in region-wide aggregate load represented by a potential electric drayage fleet, it must also be recognized that these loads would be concentrated in regions where trucks currently park and would create more acute utility infrastructure challenges than if they were spread across utility service territories like peak loads.

⁸⁶Wall-to-wheels efficiency based on California Air Resources Board, “Analyses Supporting the Addition or Revision of Energy Economy Ratio Values for the Proposed Low Carbon Fuel Standard Amendments,” Appendix H to the Initial Statement of Reasons, March 2018, <https://www.arb.ca.gov/regact/2018/lcfs18/apph.pdf>

2018 Feasibility Assessment for Drayage Trucks –
Section 8: Assessment of Infrastructure Availability

Table 25. Size of SCE and LADWP Utilities

| Indicator | Southern California Edison ⁸⁷ | Los Angeles Department of Water and Power ⁸⁸ |
|--------------------------------------|--|---|
| Service Territory (mi ²) | 50,000 | 464 |
| Service Population (ppl) | 15,000,000 | 1,500,000 |
| 2017 retail sales (MWh) | 85,879,000 | 26,000,000 |
| 2017 peak load (MW) | 23,508 | 6,502 |
| 2017 Capital Projects Budget (\$) | 3,835,000,000 ⁸⁹ | 1,400,000,000 ⁹⁰ |

Interviews with staff from both SCE and LADWP reveal that there is a high level of confidence that the five-year load forecast at the Ports can be met by the systems currently in the ground. This assessment does not include new loads for EV truck charging as neither utility is currently able to forecast where and when drayage trucks might charge. It is clear that some trucks domicile near the ports and may benefit from grid improvements made to support growing port electrical loads. However, many trucks domicile away from the ports and will require infrastructure improvements throughout the two utilities service territories. Both utilities have recently received budgetary approvals to begin developing charging infrastructure for heavy-duty trucks in their service territories and their programs are at varying stages of implementation. There is significant uncertainty over how rapidly new charging stations and subsequent EV charging loads will be deployed, given the highly innovative and relatively nascent state of this market. Similar limitations on technical certainty prevent each utility from developing a long-term infrastructure plan for a fully electrified port system. Specific knowledge gaps facing the utilities include drayage truck battery capacities and charging rates; truck charging times and locations; charging equipment interface standards and exceptions; and timelines for scaled-up EV deployments.

While both utilities are engaged in supporting the growth of the heavy-duty EV truck market, some context for the scale of charging infrastructure development needed to support the drayage fleet is warranted. Tesla’s current worldwide Supercharger network for light-duty cars consists of 1,359 sites and 11,234 charging stalls.⁹¹ At a peak power of approximately 760 MW⁹², the entire Tesla Supercharger network is substantially smaller than the estimated charging infrastructure required to fully electrify the port drayage fleet. This level of development is likely to strain or wholly exceed the capabilities of existing DC fast charger suppliers and the associated supply chain of designers, installers, and maintenance support staff in the region. While electrical infrastructure development could occur by 2021 to support some number of EV trucks, it is effectively impossible to develop sufficient infrastructure to support the electrification of the majority of drayage trucks by 2021.

8.4.3. Codes and Standards

EV charging infrastructure has developed rapidly over the last decade as multiple light-, medium, and heavy-duty vehicles have come to market. In the U.S., there are multiple charging interfaces and standards in use, including:

⁸⁷ Edison International, “Edison International and Southern California Edison 2017 Annual Report”, 2017, <https://www.edison.com/content/dam/eix/documents/investors/corporate-governance/2017-eix-sce-annual-report.pdf>

⁸⁸ Los Angeles Department of Water & Power, “Briefing Book: 2017-2018”, https://www.ladwp.com/ladwp/faces/ladwp/aboutus/a-financesandreports/a-fr-reports?_adf.ctrl-state=1bp7g1adz_b_4&_afLoop=1570165486631095

⁸⁹ SCE reported this amount in capital expenditures for 2017.

⁹⁰ LADWP reported this amount of its budget dedicated to capital projects.

⁹¹ Tesla.com, November 11, 2018, <https://www.tesla.com/supercharger>

⁹² Stalls are generally capable of up to 120 kW, but power is typically shared between two stalls at a maximum of 135 kW.

2018 Feasibility Assessment for Drayage Trucks –
Section 8: Assessment of Infrastructure Availability

- **CHAdeMo** – This standard is commonly used by Japanese and Korean auto manufacturers. Until recently, this standard supported charging rates up to 62.5 kW, but has been expanded to 200 kW charging rates with the intent of further expansion to 350-400 kW rates. The standard supports AC charging and DC fast charging over the same connector.
- **Combined Charging System (CCS)** – In the U.S., the CCS Type 1 connector is commonly used on U.S. and German auto manufacturers’ vehicles and on various heavy-duty trucks and buses. Rates of 50 kW are common for light duty vehicles but the standard supports charging rates of over 350 kW. These higher power rates may require the use of liquid cooled cables. Additionally, the standard contains specifications for overhead (catenary) charging interfaces, but these interfaces are currently only being applied to transit buses in the U.S. Long term, the CCS standard is being revised to support charging rates of over 1.6 MW, intended to support heavy-duty trucking and similar applications.
- **Tesla** – A proprietary standard developed by Tesla and currently used only on their passenger cars. It is anticipated that Tesla will develop a proprietary charging interface for its Semi platform to support the “mega-charger” rates of 1-2 MW implied by their claims to recharge a truck to 80% state of charge in 30 minutes.
- **Proprietary AC/On-board Charging** – Some heavy-duty vehicle manufacturers integrate battery charging power electronics on-board the vehicle, allowing the vehicle to accept standard AC utility power – typically as 240V single phase or 208-480V three phase power. The external “charging” equipment is technically electric vehicle supply equipment (EVSE) that acts primarily to safely connect, monitor, and disconnect the AC power from the vehicle. Because the power electronics are incorporated into the vehicle, the external EVSE can be significantly less expensive than comparable DC fast chargers but is typically proprietary to a specific vehicle manufacturer.

As can be seen by the numerous charging standards in use in the U.S., the heavy-duty vehicle industry has yet to unify around a particular interface. CCS appears to be the emerging winner in the heavy-duty space, but even within the CCS standard, ongoing revisions to increase charging voltages and the allowance for a range of charging rates means that battery-electric truck operators may encounter significantly variable charging performance at stations, even if those stations support the same charging standard employed by the truck. As charging voltages increase over time to support higher power levels, older vehicles will likely find that they cannot take advantage of these higher charging rates. However, the landscape for heavy-duty EV charging infrastructure is rapidly maturing and a single standard has yet to emerge as the clear winner. This is an existing barrier that stakeholders repeatedly stress will need resolution before any large-scale roll out of heavy-duty battery electric vehicles is likely to occur.⁹³

As noted in Section 8.3.3 in regard to natural gas fueling infrastructure, the existence of codes and standards for electric charging infrastructure do not guarantee that local authorities will not impose additional permitting requirements that can create significant barriers to infrastructure development. The diversity of charging equipment and associated power levels can further add complexity to the permitting process, as local authorities may have experience with light-duty charging infrastructure but not with heavy-duty charging infrastructure. While these issues will ultimately be addressed as local authorities and infrastructure developers gain experience, early infrastructure projects will undoubtedly require more time to permit than latter projects, slowing the pace of infrastructure development in the near-term.

⁹³ Peer review input to authors by National Renewable Energy Laboratory, November 2018.

8.5. Additional References for Assessing Infrastructure Availability

North American Council on Freight Efficiency (NACFE) – As previously noted, NACFE⁹⁴ identified several “hot button” issues specifically related to building out charging infrastructure for heavy-duty battery-electric trucks. Table 26 summarizes each infrastructure-related issue, and NACFE’s key associated findings.

Table 26: “Hot button” infrastructure-specific issues identified by NACFE for battery-electric trucks

| Issue Topic | Summary of NACFE’s Infrastructure-Related Findings (Relevant to Class 8 Drayage) |
|--|---|
| Affordable Access to Charging Infrastructure | Off-shift charging of vehicles is possible today with existing systems. Commercial battery-electric trucks need fast charging speeds (sub 30-minute), which requires high capacity production charging systems that are only in a “conceptual phase” today. While “high speed systems are thought feasible by a range of experts,” their “practicality is still a question.” |
| Speed of Charging | Charging speeds depend on each fleet’s duty cycles, as well as specific route scheduling. While many operations have defined cycles that permit off-cycle daily charging, Class 8 fleets that require sub-30 minute charging may not yet be able to find “practical commercial vehicle capable charging technology.” |
| Grid Readiness for Large-Scale Charging | Major market penetration for commercial battery-electric trucks will be on “a decades time scale.” The U.S. has energy production capacity for significant volumes of electric cars and trucks. Adding vehicle charging stations to a warehouse or factory is like adding a new line, a process utilities regularly perform for commercial sites. High rate charging expected for any sub-30 minute charging of commercial vehicles, does create a significant demand on the grid. Alternatives to mitigate this through leveling and storage systems are being considered. |
| Source: Summarized (by the authors) from Section 31 of referenced NACFE report. | |

As indicated in the table, the NACFE study concluded that charging infrastructure for Class 8 battery-electric trucks will need to be built-out on a “decades scale.” However, NACFE also concluded that “new business opportunities” could spur utilities and third parties to significantly accelerate that timeline with a focus on building charging stations for use at factories and warehouses. NACFE noted that the lack of current infrastructure for heavy-duty battery-electric trucks is actually “an opportunity for market growth,” when considering synergy with vehicle development:

“Infrastructure generally always follows product innovation. New technologies spawn development of improved infrastructure. That development encourages product market penetration, a recurring cycle seen in many new technologies.”⁹⁵

2018 UC Davis Report on Battery-Electric and Fuel Cell Technologies - In October 2018, researchers from the Institute of Transportation Studies at the University of California, Davis released a report titled “A Comparison of

⁹⁴ North American Council for Freight Efficiency, “Guidance Report: Electric Trucks – Where They Make Sense”, May 2018, obtained directly from NACFE ([available online at https://nacfe.org/report-library/guidance-reports/](https://nacfe.org/report-library/guidance-reports/)).

⁹⁵ North American Council for Freight Efficiency, “Guidance Report: Electric Truck – Where they Make Sense”, 2018, page 100.

2018 Feasibility Assessment for Drayage Trucks –
Section 8: Assessment of Infrastructure Availability

Zero-Emission Highway Trucking Technologies”.⁹⁶ This report provided a detailed review of the “challenges and costs” – related to both vehicles and infrastructure – associated with three ZE fuel-technology platforms for long-haul trucking: 1) battery-electric with “dynamic inductive charging”; 2) catenary electric; and 3) hydrogen fuel cell. NZE technologies (natural gas or propane ICE) were not included in this assessment.

The study was specifically focused on long-haul Class 8 trucks with daily driving ranges and trip distances well in exceedance of the norm for drayage trucking. Nonetheless, many of the key findings and conclusions from this report are relevant to Class 8 drayage trucking.

Key relevant infrastructure-related conclusions from the study were:

- There are “significant infrastructure challenges” associated with all three technologies.
- It would take “massive investments” to build the “truck accessible hydrogen stations and highway electric charging infrastructure” that would be needed to implement a regional ZE trucking corridor.
- “At this time, it is difficult to fully assess the cost of fueling and charging infrastructure for the zero-emission long-haul trucking technologies. Better estimates of the cost of the infrastructure and how this scales will be possible after more and larger demonstrations of the technologies are completed.”⁹⁷
- “In the near-to-mid-term, electrifying an entire state or regional highway system or deploying large hydrogen stations at many truck stops would require very large investments even though there could initially be few zero-emission long-haul trucks in use. Low utilization would make it very difficult to justify the high investment costs.”⁹⁸

⁹⁶ Zhao, Hengbing, PhD; Wang, Qian; Fulton, Lewis, PhD; Jaller, Miguel, PhD; Burke, Andrew, PhD; University of California, Davis, “A Comparison of Zero-Emission Highway Trucking Technologies,” October 2018, <https://escholarship.org/uc/item/1584b5z9>.

⁹⁷ Ibid, page 42.

⁹⁸ Ibid, page 42-43.

2018 Feasibility Assessment for Drayage Trucks –
Section 8: Assessment of Infrastructure Availability

8.6. Summary of Findings for Infrastructure Availability

Table 27 summarizes whether, according to the specific criteria and base considerations outlined above, the two commercially available ZE or NZE drayage truck platforms have sufficient “infrastructure availability” as of late 2018. In the final column of the table, snapshot ratings are provided about the degree to which they already meet these basic considerations today, or at least are showing measurable progress towards achieving them by the end of 2021.

Following the table, further discussion is provided about 1) the rationale used to assign the ratings in the table, and 2) the broad implications to the overall 2018 Drayage Truck Feasibility Assessment.

Table 27. Summary of ratings by key criteria: 2018 Infrastructure Availability

| Infrastructure Criteria / Parameter | Base Considerations for Assessing Infrastructure Availability | Achievement of Criteria for Remaining Drayage Truck Platforms | |
|---|--|---|------------|
| | | ZE Battery-Electric | NZE NG ICE |
| Dwell Time at Station | Refueling/recharging can be accommodated within typical work breaks, lunches, other downtime compatible with trucking company schedules and operational needs. | | |
| Station Location and Footprint | Fleets have existing onsite access to fueling infrastructure, or can be fueled/charged conveniently and affordably off site, at public or private stations. New infrastructure can be installed without extensive redesign, reconfiguration or operational disruptions and there is sufficient electrical or natural gas capacity at the site. | | |
| Infrastructure Buildout | Infrastructure can be constructed at a pace consistent with fleet adoption and able to meet fleet fueling/charging requirements by the end of the assessment period. | | |
| Existence of / Compatibility with Standards | A sufficient body of codes and standards exist from appropriate organizations that enables safe and effective refueling/recharging. The refueling/recharging station technology has already been installed at other trucking companies in the U.S., with sufficient time to assess performance and safety. | | |
| <p>Legend: Infrastructure Availability (2018)</p> | | | |
| <p>Source: based on preliminary OEM survey responses, OEM product information, various government sources, and Tetra Tech team’s industry knowledge.</p> | | | |

NZE Natural Gas ICE – Drayage trucks powered by natural gas ICE technology are farthest along the path of “infrastructure availability.” Infrastructure solutions are well-known and available for on-site fast-fill and time-fill strategies. Additionally, CNG, LNG, and LCNG solutions are currently in-use for heavy-duty fast-fill stations; including public access stations that replicate diesel-like centralized fueling options. Dwell times can be longer than diesel, but are expected to be in the range of 15-30 minutes.

While infrastructure solutions are readily available, their applicability to any individual fleet yard must be determined on a case-by-case basis. In particular, fleets that rely on wet-hosing to fuel their trucks on-site are unlikely to find fully equivalent solutions for CNG trucks, potentially forcing some fleets to rely on public fueling infrastructure rather than their current on-site diesel solutions.

2018 Feasibility Assessment for Drayage Trucks –
Section 8: Assessment of Infrastructure Availability

The ability of the industry to build out the required fueling infrastructure at the pace needed to support a fully natural gas-fueled fleet by 2021 is unclear. The number of sites needed to support the full drayage fleet is significant, but could be achieved if infrastructure development began in earnest quickly and selected sites did not face significant permitting or design challenges.

ZE Battery-Electric – Battery-electric truck charging standards are rapidly developing, but the industry remains in a state of change and no single standard has yet emerged as the clear winner. This is likely to delay technology adoption as fleets seek to avoid the need to support multiple charging standards and potential incompatibilities between trucks and charging locations.

Where overnight charging is possible, station dwell times are largely a non-issue as the driver is not required to be present during the charging process. However, it is very likely that public access charging infrastructure will be needed to support fleets that do not have appropriate locations to support overnight charging for trucks. To date, no example of a commercial public access charging station for heavy-duty trucks exists in the U.S., leaving open many questions about the feasibility of such an approach.

The scope of the infrastructure build-out for a fully electrified drayage fleet is substantial and does not appear to have any parallel in the U.S. with regard to the size, capacity, and speed of deployment of the charging network that would be required. It appears highly unlikely, if not impossible, to develop the full charging infrastructure needed by 2021, even if public access charging strategies and clarity on charging standards were not barriers to deployment.

9. Assessment of Economic Workability

9.1. Criteria and Methodology

This subsection compares the capital costs (CapEx) and operational costs (OpEx) associated with purchasing and deploying NZE or ZE platforms as compared to baseline diesel costs. This includes the costs of installing and maintaining specialized fueling infrastructure. It considers the availability of government incentives to buy down the capital costs of vehicles, equipment, and fueling infrastructure.

The key parameters and base considerations that were collectively used to assess economic considerations and issues are listed in the table below.

Table 28: Criteria for Assessing Economic Workability for Emerging Drayage Truck Platforms

| Economic-Related Criteria / Issue | Base Considerations for Assessing General Economic Workability |
|---|--|
| Incremental Vehicle Cost | The upfront capital cost for the new technology is affordable to end users, compared to the diesel baseline. |
| Fuel and Other Operational Costs | The cost of fuel / energy for the new technology is affordable, on an energy-equivalent basis (taking into account vehicle efficiency). Demand charges / TOU charges (if any) are understood and affordable. Net operational costs help provide an overall attractive cost of ownership. |
| Infrastructure Capital and Operational Costs | Infrastructure-related capital and operational costs (if any) are affordable for end users. |
| Potential Economic or Workforce Impacts to Make Transition | There are no known major negative economic and/or workforce impacts that could potentially result from transitioning to the new equipment. |
| Existence and Sustainability of Financing to Improve Cost of Ownership | Financing mechanisms, including incentives, are in place to help end users with incremental vehicle costs and/or new infrastructure-related costs, and are likely remain available over the next several years. |
| Source: Based on criteria in San Pedro Bay Ports’ “Framework for Developing Feasibility Assessments”, November 2017. | |

Cost comparisons between baseline diesel trucks and alternative low emission technologies are made on a total cost of ownership basis using the average operating assumptions shown in Table 29. The results of this analysis are presented and discussed following a presentation of the major cost elements in the total cost of ownership model.

Table 29. Average operating assumptions

| Average Operational Assumption for Economic and Infrastructure Analyses | | |
|---|-------|------|
| <i>Average Shift Distance</i> | miles | 160 |
| <i>Average Shift Duration</i> | hours | 9.9 |
| <i>Average Shifts per Day</i> | #/day | 1.6 |
| <i>Average Daily Operating Time</i> | Hours | 14.8 |
| <i>Average Daily Mileage</i> | miles | 238 |

9.2. Incremental Vehicle Capital Costs

The purchase price of a new drayage truck is a function of several factors including equipment specifications, warranties, demand, and purchase volume discounts. To establish a reasonable baseline diesel truck cost, respondents to the drayage truck operator survey were asked to estimate the average purchase price, including taxes, for new and used drayage trucks. As shown in Table 30, the weighted average of the reported purchase price for new trucks was \$127,774 and the weighted average price for used trucks is \$54,757. These prices are inclusive of taxes. For new trucks, taxes are assumed to include a 12% federal excise tax on new commercial trucks and a 9% sales tax. Used truck prices include only the 9% sales tax.

Table 30. Baseline Diesel Purchase Prices

| | New Truck Purchase Price | Used Truck Purchase Price |
|---------------------------|--------------------------|---------------------------|
| <i>Min</i> | \$80,000 | \$20,000 |
| <i>Max</i> | \$170,000 | \$85,000 |
| <i>Average</i> | \$121,935 | \$47,791 |
| <i>Weighted Average</i> | \$127,774 | \$54,757 |
| <i>Mode</i> | \$125,000 | \$50,000 |
| <i>Standard Deviation</i> | \$19,685 | \$13,790 |

Natural gas truck purchase price estimates were based on a reported incremental cost for CNG trucks relative to a new diesel truck. Truck OEMs indicated an average incremental cost of \$55,000 pre-tax, or \$66,550 inclusive of taxes. This is consistent with additional discussions with natural gas industry experts for trucks with fuel systems capacities of 120-160 DGE.

Electric truck pricing is based on truck OEM estimates and on examples in the California HVIP program and the New York Truck Voucher Incentive program. The New York program lists the retail price of BYD and TransPower Class 8 trucks at \$300,000 to \$350,000.⁹⁹ The California program does not list a retail price for these vehicles, but program rules limit the maximum amount of the truck incentives to approximately \$150,000 and cannot fund more than the incremental cost of the vehicle. BYD’s Class 8 truck currently qualifies for this maximum incentive.¹⁰⁰ This implies that the incremental cost would be at least \$150,000 and would place the minimum sales price for these trucks at approximately \$260,000 (pre-tax). One surveyed truck OEM indicated a typical sale price of \$300,000 for an electric Class 8 truck. It must be noted that the pricing indicated above is representative of older models. For example, BYD recently updated the specifications of its 8TT model to a 435 kWh battery pack, a significant increase over the 188-kWh battery pack referenced in the HVIP program. BYD notes that the \$300,000 price point does not apply to the new 8TT model, but that pricing has not yet solidified for the new model.¹⁰¹ In lieu of current pricing for the new 8TT, this assessment continues to use the prior price point, recognizing that this may be lower or higher than the actual pricing when it is announced.

The baseline battery-electric truck configuration considered in this feasibility assessment is equipped with a 435 kWh battery pack capable of a 207-mile range at an energy consumption rate of 2.1 kWh/mile. This is sufficient

⁹⁹ “NYSEV-VIF ‘All-Electric’ Vehicle Eligibility List”, Truck-VIP.ny.gov, <https://truck-vip.ny.gov/NYSEV-VIF-vehicle-list.php>

¹⁰⁰ “BYD Q3M (8TT) Class 8 Battery-Electric Tractor Trailer,” CaliforniaHVIP.org, <https://www.californiahvip.org/vehicles/byd-q3m-tt-class-8-battery-electric-tractor-trailer/>

¹⁰¹ Comments provided by BYD on the Draft version of this Feasibility Assessment, January 30, 2019.

2018 Feasibility Assessment for Drayage Trucks –
Section 9: Assessment of Economic Workability

range to serve the average truck working a single shift, but it is well below the 600-mile range needed to serve the BAT specification. To meet this specification, an electric truck would need an estimated 1,260 kWh of battery capacity. No electric truck is currently commercially available with such range. To estimate the purchase price of an electric truck with a 600-mile range, it is assumed that the primary driver of incremental cost would be the incremental cost of the larger battery pack. There is very little literature or available data on heavy-duty vehicle battery pack costs. NREL estimated the cost of heavy-duty battery packs by applying a 1.5 cost multiplier to the projected cost of light-duty battery packs.¹⁰² Approximate values of the battery pack price projections from the NREL study are shown in Figure 12. In the 2020 timeframe, heavy-duty battery pack costs are estimated at \$370/kWh. To produce a truck with a 1,260-kWh battery pack would require adding 825 kWh of capacity to the baseline electric truck configuration, at an estimated cost of \$305,000. This would result in an estimated purchase price of \$605,000 for a battery-electric truck with sufficient range to meet the BAT specification.

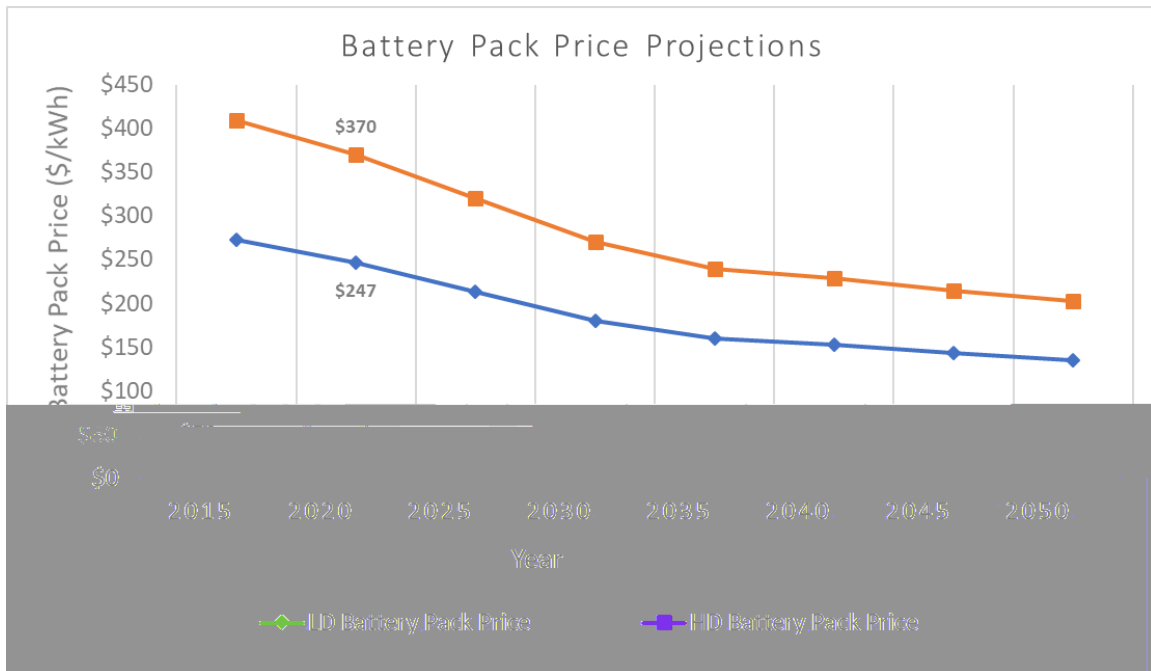

Figure 12: Battery pack price projections.

Table 31 summarizes the purchase price assumptions for each of the vehicle configurations analyzed.

Table 31. Vehicle Purchase Price Assumptions

| | Used Diesel | New Diesel | NZ CNG | Current BEV | BAT BEV |
|-----------------------|-------------|------------|-----------|-------------|-----------|
| <i>Purchase Price</i> | \$50,236 | \$105,599 | \$160,599 | \$300,000 | \$605,000 |
| <i>Taxes</i> | \$4,521 | \$22,176 | \$32,120 | \$60,000 | \$121,000 |

¹⁰²Jadun P. et al, “Electrification Futures Study: End-Use Electric Technology Cost and Performance Projections through 2050”, 2017. Golden, CO: National Renewable Energy Laboratory. <https://www.nrel.gov/docs/fy18osti/70485.pdf>

9.2.1. Financing Costs

When considering the cost of purchasing a new truck, it is important to recognize that many drayage truck owners are owner/operators or fleets with low asset bases. These companies are very likely to require financing to purchase new trucks, particularly under accelerated replacement scenarios and/or when purchasing alternative fuel trucks that have significantly higher purchase prices than baseline diesel vehicles.

On August 6th, 2018, the Ports’ Sustainable Supply Chain Advisory Committee¹⁰³ heard from several major truck manufacturers and truck financing entities regarding the challenges of and needs for financing new natural gas and battery-electric drayage trucks. In response to that meeting, nine organizations provided estimated finance costs, interest rates, and loan/lease terms to inform the Committee’s ongoing discussions. The interest rates considered ranged from 8% to 19%, depending on credit risk of the applicant. An average interest rate of 12.5% was calculated from participant responses, representing a mid-range credit risk assumption. Additionally, all organizations quoted terms of five or six years, with one organization quoting up to seven years. The most commonly quoted term was five years. Based on these responses, the financing costs for truck purchases assumes a 12.5% interest rate and a five-year loan term.

9.3. Fuel, Operational, and Maintenance Costs

Estimates of fuel costs and other operational and maintenance costs were developed and incorporated into the economic modeling of the total cost of ownership for each vehicle configuration. These estimates are summarized in Table 32 and described in the following sections.

Table 32. Fuel economy, fuel price, and other O&M cost assumptions

| | Units | Used Diesel | New Diesel | NZ CNG | Current BEV | BATS BEV |
|-----------------------------------|-------------|-------------|------------|--------|------------------------------|------------------------------|
| <i>Fuel Economy</i> | mpDGE | 6.0 | 6.0 | 5.1 | 15.1 | 15.1 |
| <i>Fuel Price</i> | \$/DGE | \$3.88 | \$3.88 | \$2.92 | \$3.51 (SCE) \$5.64 (DWP) | \$3.51 (SCE) \$5.64 (DWP) |
| <i>Maintenance</i> | \$/mi | \$0.22 | \$0.16 | \$0.16 | \$0.08 | \$0.08 |
| <i>Diesel Exhaust Fluid (DEF)</i> | % of Diesel | 4% | 4% | 0% | 0% | 0% |
| <i>DEF Price</i> | \$/gal | \$4.00 | \$4.00 | \$4.00 | \$4.00 | \$4.00 |

9.3.1. Fuel Economy

The basis of the fuel economy estimates used in this analysis are detailed in Section 0

9.3.2. Fuel Price

Diesel and CNG fuel pricing are based on average fuel prices for the West Coast as reported by the U.S. Department of Energy in the Clean Cities Alternative Fuel Price Report.¹⁰⁴ These prices are based on retail pump pricing and are inclusive of all federal and state motor fuel taxes. Because the Metro study indicated that drayage fleets primarily use commercial fueling facilities, fuel prices for public access (retail) stations are used. Diesel trucks also consume diesel emission fluid (DEF) as part of the operation of the SCR system used to control NOx emissions.

¹⁰³ “Sustainable Supply Chain Advisory Committee,” <https://www.portoflosangeles.org/environment/progress/advisors/>

¹⁰⁴ US Department of Energy, “Clean Cities Alternative Fuel Price Report”, July 2018, https://www.afdc.energy.gov/uploads/publication/alternative_fuel_price_report_july_2018.pdf

2018 Feasibility Assessment for Drayage Trucks –
Section 9: Assessment of Economic Workability

The consumption rate of DEF is typically specified by the manufacturer as a percentage of the fuel consumption. For example, a 4% DEF consumption rate indicates that 4 gallons of DEF would be used for every 100 gallons of diesel fuel. DEF costs were estimated by reviewing current DEF prices reported by Flying J at their California truck stops.¹⁰⁵

Electricity pricing for EV charging is complex and varies based on several factors, including power demand, time of day, utility rate structure, and total energy consumption. To estimate average electricity costs for EV charging, three charging scenarios were evaluated:

1. A truck performing the average daily operations shown in Table 29. This truck is assumed to travel 238 miles per day and charge once per day over nine hours.
2. A truck performing the average daily operations for a single-shift truck. This truck is assumed to travel 161 miles per day and recharge over 14 hours.
3. A truck performing the average daily operations for a two-shift truck. This truck is assumed to travel 275 miles per day and recharge over five hours.

In the scenarios described in the following table, all charging is assumed to complete by 6:00 am for service of the ports by 7:00 am. Additionally, each charging scenario was evaluated under three tariff rates; SCE's TOU-EV-9 (2-50 kV)¹⁰⁶ and LADWP's TOU A-2 rates. The results of the analysis are summarized in Table 33. Costs for the Average Truck scenario ranged from \$0.094-\$0.151/kWh, with an average rate of \$0.123/kWh. The Single-Shift Truck scenario costs were equal to the Average Truck scenario. The Two-Shift Truck scenario costs \$0.094-\$0.183/kWh and averaged \$0.139/kWh. The substantial difference in average electricity costs between the two utilities is based on different demand charge structures. Under SCE's 2018 General Rate Case, the utility proposes to establish a series of EV-related rates. These rates eliminate demand charges for a period of five years, while increasing energy charges to recover a portion of the cost recovery that is lost from adjusting the demand charges. These changes are designed to address the utility's obligations under SB-350 to support transportation electrification. By contrast, LADWP's rate is a traditional general services structure with time-variable demand charges that increase the cost of power during peak periods. The result of the SCE EV rate structure is to lower costs for EV charging relative to a general services rate such as the one modeled for LADWP.

A scenario was also evaluated for an average truck that partially recharges between shifts. Under this scenario, the truck completes a 148-mile shift, recharges sufficiently to complete a 90-mile shift, and then completes the second shorter shift before returning to base to fully recharge overnight. In this scenario, the brief charging period between shifts demands substantially more power than the overnight charging period and occurs when time-of-use energy and demand charges are higher. The result is an average electricity cost of \$0.366/kWh under the LADWP rate and \$0.163/kWh under the SCE rate, roughly twice the cost of the Average Truck scenario that charges entirely overnight. This highlights the challenge evaluating costs for EVs under a diverse range of operating scenarios within the drayage market. For the purposes of this economic analysis, it is assumed that fleets would employ overnight charging almost exclusively. In this case, electricity costs are assumed to be the rates for the Average Truck scenarios of \$0.094/kWh (SCE) and \$0.151/kWh (LADWP).

¹⁰⁵ Pilot Flying, <https://pilotflyingj.com/fuel-prices/> Reviewed October, 2018.

¹⁰⁶ As proposed in SCE's Advice Letter 3853-E. These rates are not final and are pending Public Utility Commission approval.

2018 Feasibility Assessment for Drayage Trucks –
Section 9: Assessment of Economic Workability

Table 33. EV Charging Cost Analysis Results

| Scenario | Average Truck | 1-shift Truck | 2-shift Truck | Average Truck | 1-shift Truck | 2-shift Truck | Average Truck w/ mid-day recharge | Average Truck w/ mid-day recharge |
|------------------------------|----------------|----------------|----------------|----------------|----------------|----------------|-----------------------------------|-----------------------------------|
| Utility | SCE | SCE | SCE | LADWP | LADWP | LADWP | SCE | LADWP |
| Rate Schedule | TOU-EV-9 | TOU-EV-9 | TOU-EV-9 | TOU A-2 | TOU A-2 | TOU A-2 | TOU-EV-9 | TOU A-2 |
| Daily Mileage (mi) | 238 | 161 | 275 | 238 | 161 | 275 | 238 | 238 |
| Daily Energy (kWh) | 595 | 403 | 688 | 595 | 403 | 688 | 595 | 595 |
| Daily Operating Time (hours) | 15 | 9.6 | 19 | 15 | 9.6 | 19 | 15 | 15 |
| Charge Window | 9p-6a | 9p-6a | 1a-6a | 9p-6a | 9p-6a | 1a-6a | 10p-6a, 4p-5p | 10p-6a, 4p-5p |
| Total Energy (kWh) | 155,295 | 105,183 | 179,568 | 155,295 | 105,183 | 179,568 | 155,295 | 155,295 |
| Peak Power (kW) | 66 | 29 | 138 | 66 | 29 | 138 | 223 | 223 |
| Energy Charges | \$10,479 | \$8,477 | \$11,431 | \$17,345 | \$12,333 | \$20,056 | \$25,347 | \$18,582 |
| Demand Charges | \$12,122 | \$5,278 | \$25,230 | \$6,164 | \$4,175 | \$12,830 | \$0 | \$38,208 |
| Total Cost (\$/year) | \$14,658 | \$9,928 | \$16,949 | \$23,509 | \$15,923 | \$32,886 | \$25,374 | \$56,790 |
| Average Cost (\$/kWh) | \$0.094 | \$0.094 | \$0.094 | \$0.151 | \$0.151 | \$0.183 | \$0.163 | \$0.366 |

9.3.3. Maintenance Costs

Baseline maintenance costs are calculated from responses to the Drayage Truck Operator survey. The majority responses to the survey produced a calculated cost per mile between \$0.05 and \$0.25, with \$0.20/mile as the weighted average cost across all responses. The responses were then divided into two groups, based on whether the fleet indicated it typically buys new trucks or used trucks. The weighted average cost per mile for new trucks is calculated at \$0.16/mile. This figure is similar to the American Transportation Research Institute’s estimated repair and maintenance costs for 2017 of \$0.167/mile.¹⁰⁷ The weighted average cost per mile for used trucks, based on the survey responses, is \$0.22/mile.

Natural gas truck maintenance costs are assumed to be equal to diesel maintenance costs. The literature contains various conflicting reports of natural gas maintenance costs relative to diesel, with some analyses reporting reduced maintenance costs and others reporting increased maintenance costs. It is likely that the differences in these results are attributable to various confounding factors in the analyses and to differences in the maintenance practices between fleets. It should also be recognized that some fleets experienced very high maintenance and repair costs for many of the natural gas drayage trucks deployed between 2007 and 2012. These trucks were equipped with an 8.9 liter natural gas engine rated at 320 HP. This engine is recommended for trucking

¹⁰⁷ Hooper, A. and Murray, D., “An Analysis of the Operational Costs of Trucks: 2018 Update”, 2018. Prepared for the American Transportation Research Institute.

2018 Feasibility Assessment for Drayage Trucks –
Section 9: Assessment of Economic Workability

applications with GCWs of less than 66,000 lbs¹⁰⁸. Operators that placed the engine in applications above 66,000 lbs encountered increased engine damage and high repair costs. The current analysis assumes the use of a 12-liter natural gas engine rated at 400 HP and intended for trucks operating at up to 80,000 lbs. Therefore, the higher failure rates and associated maintenance costs of the 8.9-liter engine observed by some operators are not assumed to be indicative of the maintenance costs of the 12-liter engine.

Battery-electric truck maintenance costs are assumed to be 50% less than the diesel baseline. This assumption is based on comments from electric truck OEMs in their responses to the Truck Manufacturer survey. Unfortunately, there is little in-use demonstration data available to validate this assumption. Additionally, these maintenance costs do not incorporate the potential cost of a battery pack replacement over the 12-year life of the truck. As previously noted, BYD currently offers a 12-year warranty on its battery packs in transit applications. Because the cost estimates used in this feasibility assessment exclude the cost of a battery pack replacement, it is implicitly assumed that the battery pack will last the full life of the vehicle or that the sales price assumed would include a 12-year battery warranty when vehicles are produced and sold in high volumes. BYD notes that it does not offer a 12-year warranty on batteries in truck applications. Hence, these are likely optimistic assumptions that cannot be further improved until maintenance cost data and more substantial battery life information are available for drayage applications.

9.3.4. Insurance, Registration, and Depreciation Costs

An often-overlooked component in total cost of ownership analyses are the impacts of insurance, registration, and depreciation. All of these costs are strongly influenced by the purchase cost of the vehicle and infrastructure.

California DMV vehicle license fees (VLF) for commercial vehicles are based on the market value of a truck, calculated using a standard depreciation schedule and applied to the sales price of the truck.¹⁰⁹ Per statute, the VLF is calculated as 0.65% of the current market value. As shown in Table 34, the greater purchase price of natural gas and battery-electric vehicles increases the VLF proportionally and can add substantial costs over the 12-year life of the vehicle.

Commercial trucks operate under many different types of insurance covering cargo, general liability, non-owned equipment, and physical damage to the truck. While the costs for most of these coverages are independent of the cost of the truck, physical damage coverage is generally calculated as a percentage of the current market value of the truck. Insurance costs are highly dependent on individual circumstances, but an approximate cost of 3% of the truck's market value is used to estimate the insurance premium for physical damage coverage. As with the VLF, a higher purchase price increases the estimated market value of the truck and the associated insurance premium.

¹⁰⁸ "ISL G", <https://www.cumminswestport.com/models/isl-g>

¹⁰⁹ California Revenue and Taxation Code §§10751, 10752, and 10753.5

2018 Feasibility Assessment for Drayage Trucks –
Section 9: Assessment of Economic Workability

Table 34. Vehicle License Fee and Insurance Cost Assumptions

| Year | Market Value | Diesel | NGV | Current BEV | Diesel | NGV | Current BEV |
|------|--------------|-----------------------|---------|-------------|--------------------|---------|-------------|
| | | Vehicle License Fee | | | Insurance | | |
| | | 0.65% of Market Value | | | 3% of Market Value | | |
| 1 | 100% | \$686 | \$1,044 | \$1,950 | \$3,168 | \$4,818 | \$9,000 |
| 2 | 90% | \$618 | \$940 | \$1,755 | \$2,851 | \$4,336 | \$8,100 |
| 3 | 80% | \$549 | \$835 | \$1,560 | \$2,534 | \$3,854 | \$7,200 |
| 4 | 70% | \$480 | \$731 | \$1,365 | \$2,218 | \$3,373 | \$6,300 |
| 5 | 60% | \$412 | \$626 | \$1,170 | \$1,901 | \$2,891 | \$5,400 |
| 6 | 50% | \$343 | \$522 | \$975 | \$1,584 | \$2,409 | \$4,500 |
| 7 | 40% | \$275 | \$418 | \$780 | \$1,267 | \$1,927 | \$3,600 |
| 8 | 30% | \$206 | \$313 | \$585 | \$950 | \$1,445 | \$2,700 |
| 9 | 25% | \$172 | \$261 | \$488 | \$792 | \$1,204 | \$2,250 |
| 10 | 20% | \$137 | \$209 | \$390 | \$634 | \$964 | \$1,800 |
| 11 | 15% | \$103 | \$157 | \$293 | \$475 | \$723 | \$1,350 |
| 12 | 15% | \$103 | \$157 | \$293 | \$475 | \$723 | \$1,350 |

Unlike VLF and insurance costs, depreciation provides a cost reduction for fleets that are able to take advantage of the tax benefits. Current federal tax rates for businesses are 21% and California tax rates for C-type corporations are 8.86%, resulting in an effective tax rate of 29.86%.¹¹⁰ Because depreciation of business equipment such as heavy-duty trucks is tax deductible, the depreciation of a truck creates a tax shield that reduces taxes paid in a year when depreciation is applied. Estimating the value of depreciation for the average drayage truck operator is difficult. The rules for depreciation are complex and truck operators may be structured as a number of business entities including sole proprietorships, partnerships, and corporations. Each of these entities have different tax rules and specific tax situations may limit the value of depreciation deductions in a given year. For the purposes of this analysis, the value of equipment depreciation is calculated as 29.86% of the capital cost and it is assumed that the equipment owner(s) of the truck and charging infrastructure are able to fully benefit from the associated deductions over the life of the equipment.

9.4. Infrastructure Capital and Operational Costs

Diesel and natural gas fueling are assumed to be provided predominately through commercial fuel stations where the capital and operational costs of the fueling infrastructure are incorporated into the fuel price. As described previously, the fuel pricing used in this analysis reflects actual pump pricing at public access stations. For this reason, the costs of infrastructure for diesel and natural gas vehicles are assumed to be zero.

Owing to the length of time required to recharge electric trucks, it is assumed that they will be charged primarily through DC fast charging infrastructure installed at fleet facilities or other locations that provide overnight parking stalls for drayage trucks. The cost of this new charging infrastructure is not included in the electricity pricing assumptions described previously. Based on the electricity charging rate analysis, the typical drayage truck would require a peak charging rate of 66 kW. This charging rate is based on a charging window roughly equivalent to the truck’s overnight downtime and implies that a one-to-one ratio of chargers to trucks is required. While a

¹¹⁰26 U.S. Code § 11, <https://www.ftb.ca.gov/businesses/faq/717.shtml>

2018 Feasibility Assessment for Drayage Trucks –
Section 9: Assessment of Economic Workability

single charger could potentially serve multiple trucks, this would either require a charger with a higher charging rate (and higher cost) or require trucks to share charging infrastructure but have non-overlapping charging windows. While both of these situations are possible, for the purposes of this economic comparison it is assumed that the typical use case would require a one-to-one ratio of chargers to trucks. Costs for the charger and associated infrastructure are based on CARB estimates for a 60 kW DC fast charger and installation, totaling \$105,000 per charger.¹¹¹ The full cost of the charger and installation are attributed to a battery-electric truck. It is recognized that the installation costs reflect long-lived improvements such as trenching, conduit, switch gear, and power lines. The service life of these improvements should extend well beyond the 12-year useful life of the first electric trucks deployed. However, to levelize the cost of this infrastructure over a period greater than the 12-year life of the vehicle, a fleet would need to amortize the investment over very long timeframes that are not the norm for commercial fleets.

Maintenance costs for EV charging infrastructure are also taken from CARB estimates and assume \$240/year in inspection costs and the replacement of one charging connection over ten years, producing a levelized cost of \$415 per year.

9.5. Incentives

Historically, incentives have played a major role in spurring drayage truck replacement by reducing the cost of the initial capital outlay. There are uncertainties, however, surrounding the long-term availability and magnitude of incentives. Additionally, these funding programs do not necessarily align with timelines for deployment; there is funding available today for vehicle purchase, but the industry may need years to develop the fueling or charging infrastructure to support these vehicles, effectively limiting the amount of incentives that can be accessed in the near term.

Given these uncertainties, this Assessment calculates the total cost of ownership with and without incentives. The cost model considers two incentive types: a purchase incentive based on the HVIP program, and an LCFS credit revenue stream. The purchase incentive is assumed to be \$45,000 for near-zero natural gas trucks and \$165,000 for battery-electric trucks. The value of LCFS credits is based on a \$149 credit price and uses the recently adopted modifications to the LCFS program that will go into effect January 1, 2019. It must be noted that credit prices under the LCFS program are based on market demand. Since the inception of the LCFS program, credit prices have varied substantially and prices react to a number of different influences. These include political/regulatory pressures, legal challenges to the LCFS program, CARB modifications to the LCFS regulation, and emergence of new sources of credit generation. The extension of the LCFS program's carbon intensity benchmarks through 2030 are no guarantee of the longevity of the program or a guarantee of credit prices under the program. To be conservative, it is recommended that economic workability be based on non-incentivized cost of ownership.

A more detailed explanation of the incentive funding calculations, including a description of the funding programs, can be found in Appendix B.

9.6. Total Cost of Ownership Results

The comparative cost of ownership analysis is based on the assumptions described in the preceding sections and in Appendix B. Table 35 summarizes the key assumptions for each technology and cost component. The analysis considers two versions of a battery-electric truck. The first is based on the current battery-electric truck product offering. This truck does not meet the BAT specification but could theoretically achieve the 68,383 miles annual

¹¹¹ California Air Resources Board, "Innovative Clean Transit – Costs and Data Sources", June 26, 2017, <https://arb.ca.gov/msprog/ict/meeting/mt170626/170626costdatasources.xlsx>. Includes costs of site work, conduit, switch gear, etc.

2018 Feasibility Assessment for Drayage Trucks –
Section 9: Assessment of Economic Workability

VMT with the estimated 207 mile/shift range. The second battery-electric truck specification is based on the estimated cost of a battery-electric truck with sufficient range to meet the BAT-compliant range requirements.

The analysis also considers a used diesel truck baseline recognizing that many drayage trucks are purchased used. It is assumed that the used diesel truck is approximately six years old when purchased and that it will have a remaining six years of useful life. Over a 12-year period, a used diesel truck is expected to be replaced once with another used truck.

Table 35. Summary of key assumptions for cost of ownership analysis

| <i>Cost Component</i> | <i>Units</i> | <i>Used Diesel</i> | <i>New Diesel</i> | <i>NZ CNG</i> | <i>Current BEV</i> | <i>BATS BEV</i> |
|--------------------------|--------------|--------------------|-------------------|---------------|------------------------------|------------------------------|
| <i>Purchase Price</i> | \$ | \$50,236 | \$105,599 | \$160,599 | \$300,000 | \$605,000 |
| <i>Taxes</i> | \$ | \$4,521 | \$22,176 | \$32,120 | \$60,000 | \$121,000 |
| <i>Infrastructure</i> | \$ | \$0 | \$0 | \$0 | \$105,000 | \$105,000 |
| <i>Interest Rate</i> | % | 12.5% | | | | |
| <i>Finance Period</i> | years | 5 | | | | |
| <i>Fuel Economy</i> | mpDGE | 6.0 | 6.0 | 5.1 | 15.1 | 15.1 |
| <i>Fuel Price</i> | \$/DGE | \$3.87 | \$3.87 | \$2.92 | \$3.51 (SCE) \$5.64 (DWP) | \$3.51 (SCE) \$5.64 (DWP) |
| <i>VMT</i> | miles/year | 68,383 | | | | |
| <i>Maintenance</i> | \$/mi | \$0.22 | \$0.16 | \$0.16 | \$0.08 | \$0.08 |
| <i>DEF</i> | % of Diesel | 4% | 4% | 0% | 0% | 0% |
| <i>DEF Price</i> | \$/gal | \$2.90 | | | | |
| <i>LCFS Credit Price</i> | \$/MT | \$149 | | | | |

Figure 13 summarizes the results of the cost of ownership analysis. The costs are reported in current 2018 dollars on a net present value (NPV) basis using a 7% real discount rate.¹¹² As shown, the cost of ownership for a new diesel truck with an average annual activity of 68,383 miles over a 12-year service life is approximately \$598,000. Near-zero natural gas truck costs are estimated to be \$625,000, within 5% of the total cost of ownership of a new diesel truck, and could be considered cost-competitive with new diesel trucks at the fuel price spreads assumed in this analysis. Battery-electric truck cost of ownership depends on the location where the truck charges, as this determines the utility rate. Within SCE territory, the current battery-electric truck is estimated to cost \$799,000 over 12 years, about \$201,000 more expensive than new diesel trucks. A BATS-compliant battery-electric truck is estimated to have a cost of ownership of \$1.06 million, \$463,000 greater than that of a new diesel truck due to the high capital cost of the larger battery. Within LADWP territory, the current battery-electric truck is approximately \$620,000 more expensive and a BATS-compliant truck is \$583,000 more expensive than a new diesel truck.

When incentives are included in the analysis, all three alternative platforms are less expensive than diesel trucks over the 12-year analysis period. Natural gas trucks receive a \$45,000 initial purchase incentive through HVIP and associated finance cost reductions for the balance of the truck purchase price. These trucks would also generate an estimated \$124,000 in LCFS credit revenue. However, because these trucks are assumed to refuel at commercial fueling facilities, the value of the LCFS credit is assumed to be accounted for in the pump price and consumed by the fuel provider to source RNG. Electric trucks receive a \$165,000 purchase incentive through HVIP

¹¹² The analysis uses a 7% real discount rate per the White House Office of Management and Budget Circular A-4 (2003)

2018 Feasibility Assessment for Drayage Trucks –
Section 9: Assessment of Economic Workability

and generate \$373,000 in LCFS credits over 12 years. The combined effect of these two very large incentives is to make the total cost of the battery-electric trucks substantially less than baseline diesel trucks.

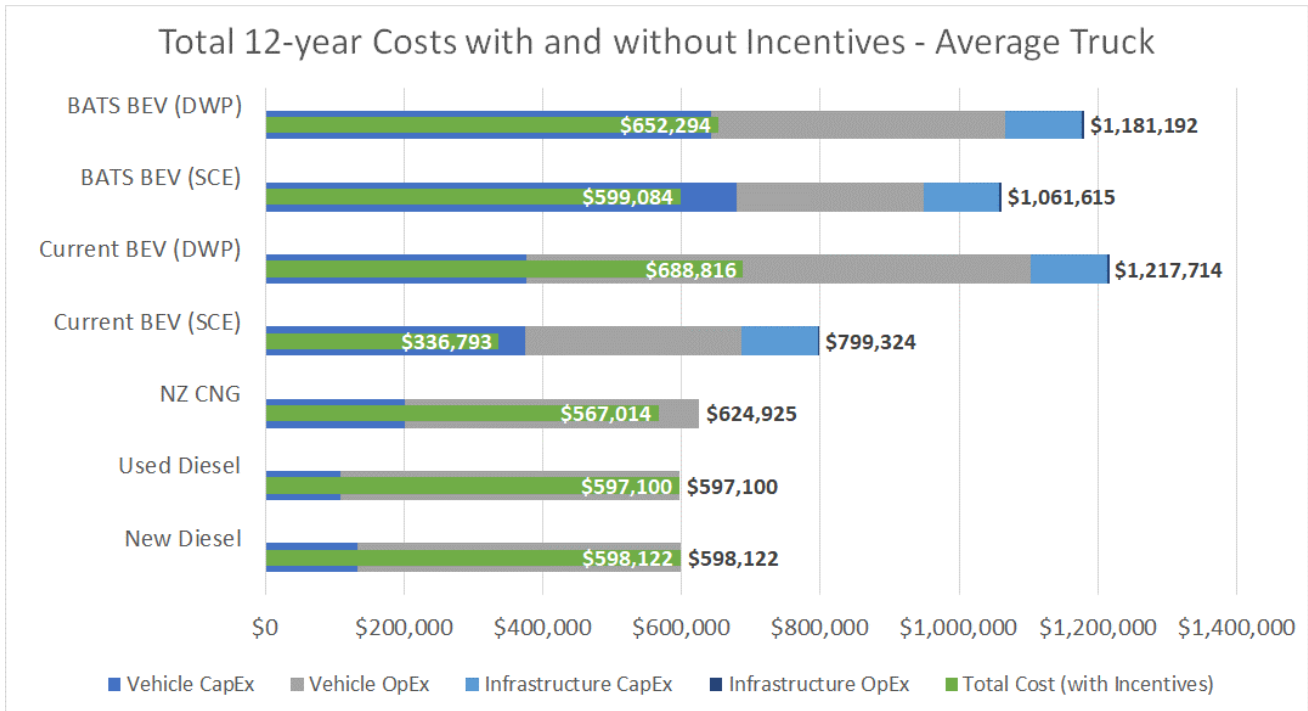

Figure 13. Total 12-year costs of ownership for “Average Truck” scenario (NPV at 7% discount rate)

Reliance on incentives to determine economic workability is problematic. These incentives are not guaranteed over the 12-year operational life of a truck. Therefore, a truck buyer must discount the value of the incentives based on their assessment of the risk of the incentives failing to materialize at the levels projected. From the perspective of economic workability to the broader drayage fleet, it must be recognized that current incentive programs do not have sufficient funds to provide the purchase incentives assumed for many trucks in the drayage fleet, and HDV allocations for future programs are not yet determined or guaranteed. With the proposed funding for HVIP in 2018/2019, the program will have an estimated \$192 million in total funds available for purchase incentives. The VW mitigation fund will have an additional \$90 million over the next three to ten years. Combined, this pot of \$282 million would be sufficient to provide a \$165,000 purchase incentive for only 1,700 drayage trucks. This is a meaningful but small fraction of the 11,000 to 18,000 drayage trucks needed to serve the ports. As stated earlier, it is recommended that economic workability be based on non-incentivized cost of ownership.

As assessment of the costs for a typical truck performing one shift per day to determine whether battery-electric technology offered a significant cost advantage over diesel in the shorter-range applications where current technology is better matched to operational requirements. The results are summarized in Figure 14. Alternative fuel trucks typically predicate lower costs of ownership on fuel and maintenance savings that offset the higher capital cost of these technologies. When annual mileage is lower, the benefits of reduced maintenance and fuel costs are proportionally lower but are not necessarily accompanied by reduced capital costs for the trucks. For a single-shift truck scenario the average daily mileage is assumed to be 161 miles, resulting in an average annual mileage of 46,000 miles. At this lower annual mileage, the cost of ownership for natural gas trucks is approximately 10% higher than new diesel and used diesel trucks. Incremental costs for current electric trucks remain similar to those for an average truck in SCE territory. However, the incremental cost of a single shift truck charging in LADWP territory decreases substantially compared to an average truck because the single shift truck

2018 Feasibility Assessment for Drayage Trucks –
Section 9: Assessment of Economic Workability

can avoid mid-day charging and reduces its effective electricity rate by almost 60%. Because the currently available battery-electric truck on the market has a range more suitable for the Single Shift Truck scenario than for the Average Truck scenario, the results for the Single Shift scenario shown in Figure 14 are more likely to be a better representation of the truck cost of ownership than those shown under the Average Truck scenario.

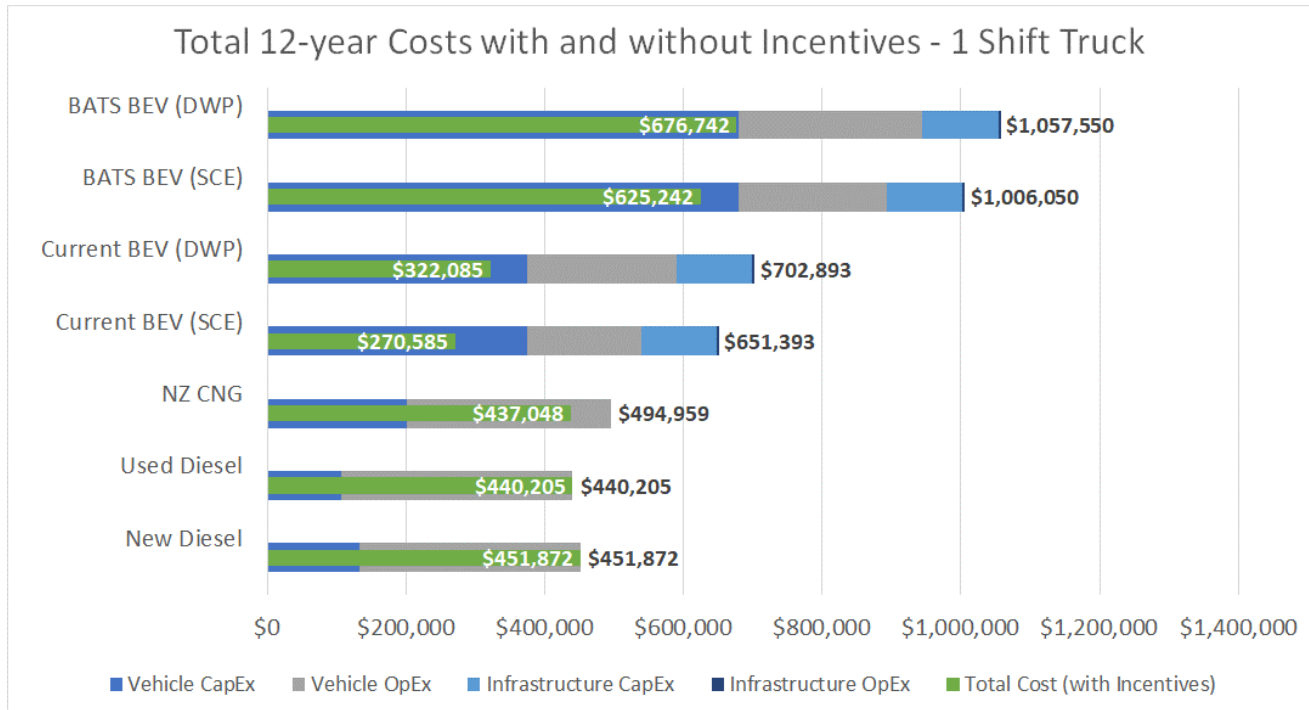

Figure 14. Total 12-year costs of ownership for the “Single Shift Truck” scenario (NPV at 7% discount rate)

9.7. Impacts on Cargo Capacity

As discussed in Section 7.5.1, both natural gas and battery-electric trucks are typically heavier than a comparable diesel truck. Cargo capacity may be reduced by the incremental weight of these trucks. The economic impact of this lost cargo capacity varies by truck operator, but as a first approximation, it can be assumed that the operator must run additional trucks to transport the lost cargo capacity. Consequently, a 2,000 lbs reduction in capacity on a 62,000 lbs load would result in a 3.2% loss in cargo capacity and require the trucking company to operate 3.6% more trucks. This is a rough, low end estimate as not all loads can be conveniently split when the truck reaches 80,000 lbs. For example, a truck hauling large steel plates may find that they must remove one plate to meet the 80,000 lbs weight limit and that plate may represent more than 3.2% of that truck’s typical capacity.

Because of regulatory changes to truck weight limits made in AB-2061 that allows near-zero and zero-emission trucks to exceed weight limits on the tractor by up to 2,000 lbs, the typical weight penalty for near-zero natural gas trucks is effectively eliminated.

The regulatory changes also reduce the effective weight penalty of the battery-electric truck by 2,000 lbs. For trucks operating at 80,000 lbs, this would leave a 5,200 lbs weight penalty for current battery electric trucks and a 10,200 lbs weight penalty for a BAT-compliant electric truck. These weight penalties translate into a loss of 8.4% and 16.5% of cargo capacity, respectively.

2018 Feasibility Assessment for Drayage Trucks –
Section 9: Assessment of Economic Workability

Also discussed in Section 7.5.1, current battery-electric trucks could haul up to 40,000 lbs containers with the weight increases from AB-2061. While this increase allows the battery-electric truck to transport many of the containers moved through the ports, many 40-45 foot shipping containers moving through the Ports are likely to be too heavy to legally transport with current battery-electric trucks. This restriction on cargo weight would likely translate into lost revenue for truck operators. A BATS-compliant battery-electric truck would be limited to approximately 28,400 lbs containers, making it unsuitable for much of the cargo transported in the Ports.

9.8. Cost Effectiveness, Workforce, and Cargo Diversion Considerations

The feasibility assessment framework adopted in November 2017 as part of the CAAP Update identified three additional areas of economic impact for consideration by the Ports. These areas are cost effectiveness of air quality reductions, workforce impacts, and costs associated with potential cargo diversion.

Cost-Effectiveness

Cost-effectiveness, generally represented as the cost per ton of emissions reduced, is a metric typically used to assess various regulations and funding programs. A major element of any cost effectiveness analysis is the choice of the costs that will be included in the analysis. To develop cost effectiveness comparisons for this Feasibility Analysis, the non-incentivized 12-year costs shown in Figure 13 for an average truck are used.

Emissions are calculated using emissions factors from ARB’s EMFAC2017 model and LCFS program, and applying those factors to the annual mileage and fuel economy indicated in Table 35. Criteria pollutant emissions factors for a new 2018 model year diesel truck are summarized in Table 36. Emissions factors were derived from EMFAC 2017’s reported total daily VMT and mass emissions for drayage trucks operating in the South Coast air basin.

Table 36. Diesel emissions factors for cost effectiveness analysis

| | PM _{2.5} | NO _x | ROG |
|--------------------------------|-------------------|-----------------|------|
| Diesel Emissions Factor (g/mi) | 0.01 | 1.91 | 0.04 |

Criteria pollutant emissions reductions are estimated based on reduction factors, shown in Table 37. Greenhouse gas emissions are estimated using the carbon intensity (CI) factors, also shown in Table 37. The CI factors for traditional fuels are based on ARB’s default values for diesel, CNG, and the current California-average grid and are the non EER-adjusted values.¹¹³ An adjustment for the energy efficiency of each technology is reflected in the fuel economy assumptions for each technology, as discussed in Section 7.5.2. The CI factor for CNG shown under the Renewable/TOU column reflect the average CI for RNG as reported by CARB under the Low Carbon Fuel Standard (LCFS) “Data Dashboard”. The CI factor for BEVs under the Renewable/TOU column is the average carbon intensity for California grid electricity delivered between the hours of 9:00 pm and 5:00 am, as reported in Table 7-2 of the LCFS regulation. This time period is consistent with overnight charging of BEVs.

Table 37. Emissions reduction factors and carbon intensity assumptions

| Technology | Reduction Factor | | | Non EER-Adjusted Carbon Intensity (gCO ₂ e/MJ) | |
|------------|------------------|-------------------|------|---|---------------|
| | NO _x | PM _{2.5} | ROG | Traditional | Renewable/TOU |
| Diesel | 0% | 0% | 0% | 100.45 | |
| NZ CNG | 90% | 0% | 0% | 79.21 | 39.60 |
| BEV | 100% | 100% | 100% | 93.75 | 91.27 |

¹¹³ California Air Resources Board, Final Regulation Order, Table 7-1 “Lookup Table for Gasoline and Diesel and Fuels that Substitute for Gasoline and Diesel.” <https://www.arb.ca.gov/regact/2018/lcfs18/fro.pdf>

2018 Feasibility Assessment for Drayage Trucks –
Section 9: Assessment of Economic Workability

Results of the cost effectiveness analysis are shown in Figure 15 and Figure 16. All cost-effectiveness calculations assume a 12-year project life and criteria pollutant emissions are represented as weighted emissions, using the Carl Moyer program methodology.¹¹⁴

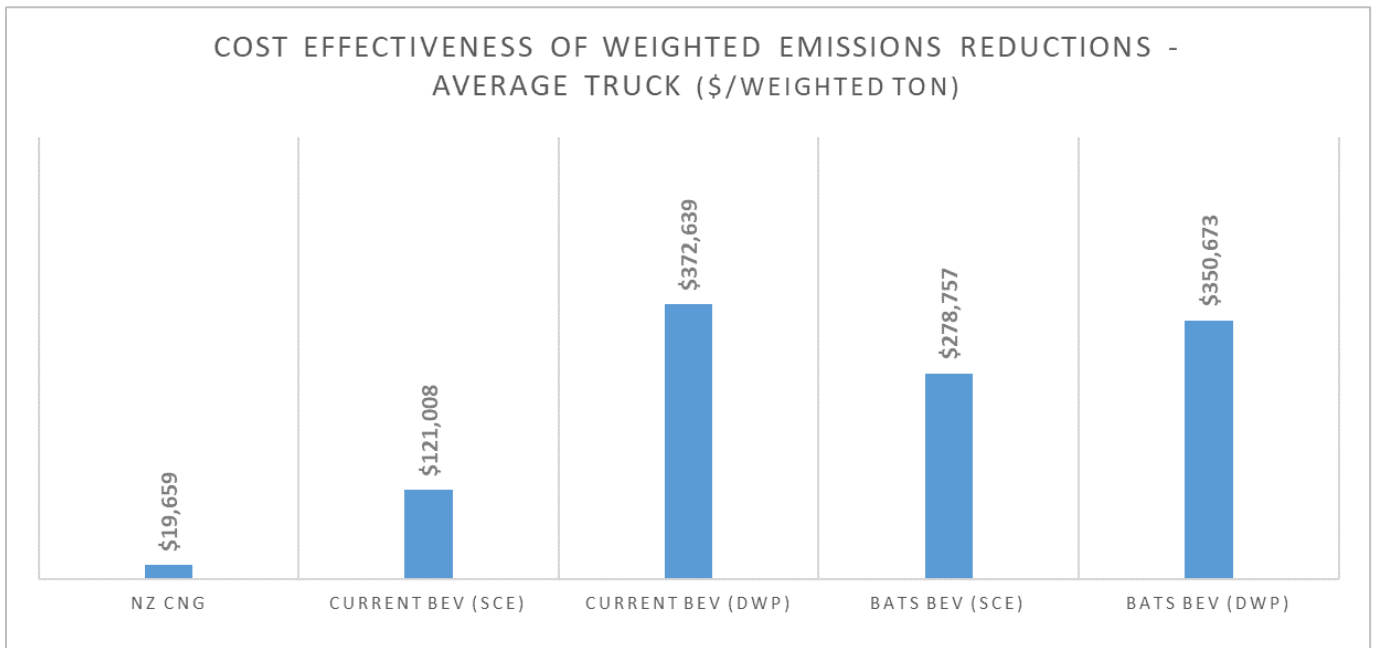

Figure 15. Cost effectiveness of criteria pollutant reductions (\$/weighted ton)

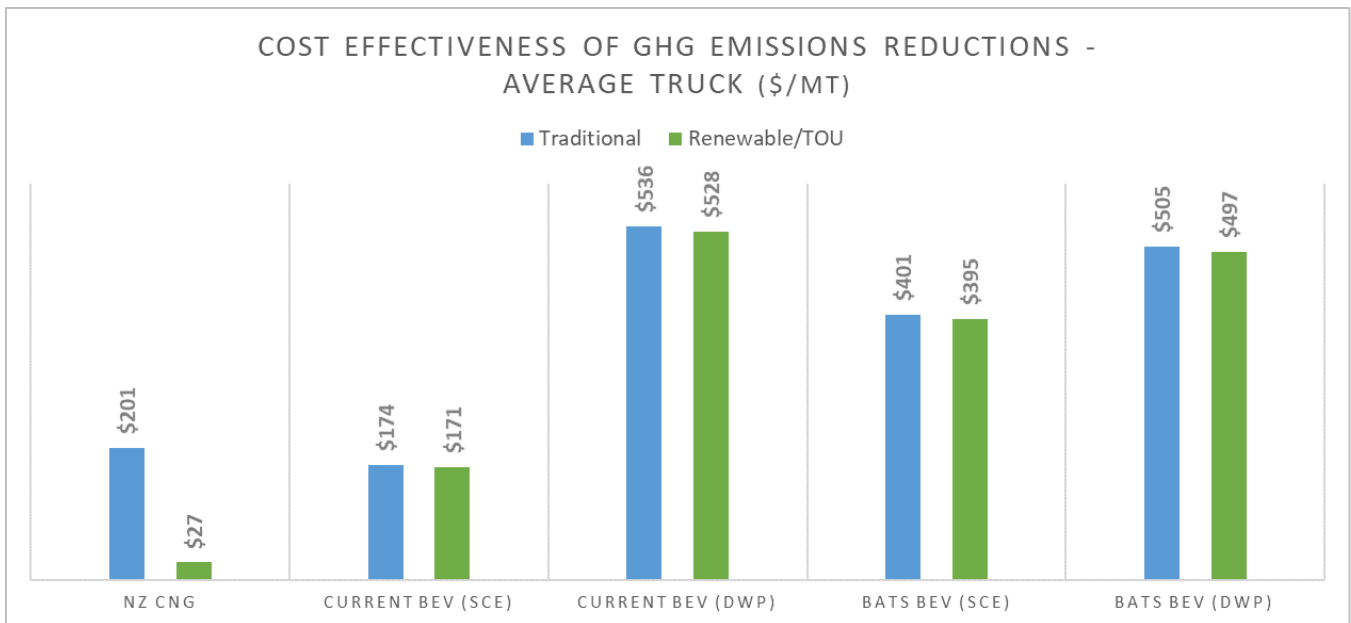

Figure 16. Cost effectiveness of GHG reductions (\$/MT)

There is no established cost-effectiveness value that is broadly considered a limit on reasonable cost effectiveness. However, the Carl Moyer program’s cost-effectiveness limit criteria can be used as one point of comparison for

¹¹⁴ Under the Carl Moyer program, NOx, PM, and ROG emissions reductions are combined into a single weighted emissions reduction factor using the formula (NOx + ROG + 20*PM) = Weighted Emissions

2018 Feasibility Assessment for Drayage Trucks –
Section 9: Assessment of Economic Workability

the cost effectiveness values calculated in this Feasibility Analysis. As shown in the figures, the cost effectiveness of criteria pollutant emissions for the near-zero natural gas truck is \$19,700 and is less than the Carl Moyer Program base limit of \$30,000 and significantly less than the \$100,000 limit for zero and near-zero on-road technologies.¹¹⁵ The cost effectiveness for BEVs varies between \$121,000 and \$373,000 per weighted ton and is slightly to significantly above the Carl Moyer Program limit of \$100,000.

For GHG reductions, the cost effectiveness of the near-zero natural gas truck is \$201 per metric ton (MT) using traditional natural gas and \$27/MT using RNG. The cost effectiveness for BEVs varies between \$171 and \$536/MT. As a point of comparison, the LCFS credit prices ranged from \$105 to \$194 per metric ton between January and November 2018.¹¹⁶

Potential for future cost-effectiveness improvements

Cost-effectiveness can be improved through lower total costs and/or greater emissions reductions. The potential for cost reductions varies by technology and pollutant. With regard to criteria pollutant cost-effectiveness, there is little or no additional emissions reduction potential that can be achieved for NZ natural gas and ZE battery-electric trucks beyond their current performance levels. Consequently, improvements in cost-effectiveness will need to come from cost reductions. For GHG cost-effectiveness, both natural gas and battery-electric technologies could benefit from cost reductions and emissions reductions.

Near-zero Natural Gas: Criteria pollutant cost-effectiveness reductions are possible with increased adoption of the technology and increased competition amongst manufacturers. Currently, only one manufacturer offers a near-zero natural gas engine suitable for drayage, hence there is no direct competitive pressure to reduce equipment costs below current levels. Should additional manufacturers enter the market, competition could reduce the incremental purchase price of the vehicle. Additionally, a more robust public access fueling network should drive competition and reductions in fuel costs.

Cost-effectiveness of GHG reductions will benefit from the cost reductions already described, and could improve as lower carbon sources of renewable natural gas enter the California market. There are a number of renewable natural gas projects in development in California that will produce natural gas from food waste, green waste, and animal waste. Many of these projects will likely have lower carbon intensities than the current average carbon intensity for RNG in California.

Battery-Electric: As with natural gas, criteria pollutant cost-effectiveness reductions will come from increased adoption of electric vehicles and increased competition from manufacturers. As noted in Section 5.2, five manufacturers anticipate bringing electric platforms to market by 2021. This increased competition, combined with the growth of EVs in the light-duty market could significantly reduce the incremental cost of these vehicles relative to today's prices.

GHG reductions are anticipated to come from increased penetration of renewable electricity in the California grid, consistent with state requirements under the Renewable Portfolio Standard. Additionally, some facilities may purchase electricity with a lower carbon intensity than the grid average based on additional value that can be derived from the LCFS program.

¹¹⁵ Cost-effectiveness limits for Carl Moyer Program are reported in Appendix C of the 2017 guidelines.

https://www.arb.ca.gov/msprog/moyer/guidelines/2017gl/2017_gl_appendix_c.pdf

¹¹⁶ Analysis based on data from California Air Resources Board LCFS Credit Transfer Activity Reports.

<https://www.arb.ca.gov/fuels/lcfs/credit/lrtcreditreports.htm>

2018 Feasibility Assessment for Drayage Trucks –
Section 9: Assessment of Economic Workability

Workforce Impacts

Costs of workforce training for alternative technology trucks are typically associated with additional training for operators and mechanics. However, because the majority of drayage truck operators currently use third party repair facilities for service and would likely rely on these facilities and/or dealers to perform repairs, additional training is expected to be primarily limited to basic preventative maintenance. Additionally, drivers may need limited training to familiarize themselves with new fueling/charging procedures. Given that these trucks are designed to mimic diesel trucks in general design and operation, it is not expected that training will create substantial economic burdens.

That said, the Ports are conducting other studies to assess the potential workforce impacts. These studies include Port of Long Beach’s “Port Community Electric Vehicle Blueprint” to be completed in June 2019 and Long Beach City College’s zero-emissions workforce assessment to be completed in early 2019.

Cargo Diversion Costs

The potential for cargo diversion and the associated economic impacts are considered in other studies being conducted by the Ports.

9.9. Summary of Findings for Economic Issues and Considerations

Table 38 summarizes whether, according to the specific criteria and base considerations (outlined above), the two commercially available ZE or NZE drayage truck platforms offer economically workable alternatives to baseline diesel trucks as of late 2018. In the final column of the table, snapshot ratings are provided about the degree to which they already meet these basic considerations today, or at least are showing measurable progress towards achieving them by the end of 2021.

Following the table, further discussion is provided about 1) the rationale used to assign the ratings in the table, and 2) the broad implications to the overall 2018 Drayage Truck Feasibility Assessment.

2018 Feasibility Assessment for Drayage Trucks –
Section 9: Assessment of Economic Workability

Table 38. Summary of ratings by key criteria: 2018 Economic Workability

| Economic-Related Criteria / Issue | Base Considerations for Assessing General Economic Workability | Achievement of Criteria in 2018 (Commercially Available Truck Platforms) | |
|--|--|--|------------|
| | | ZE Battery-Electric | NZE NG ICE |
| Incremental Vehicle Cost | The upfront capital cost for the new technology is affordable to end users, compared to the diesel baseline. | | |
| Fuel and Other Operational Costs | The cost of fuel / energy for the new technology is affordable, on an energy-equivalent basis (taking into account vehicle efficiency). Demand charges / TOU charges (if any) are understood and affordable. Net operational costs help provide an overall attractive cost of ownership. | | |
| Infrastructure Capital and Operational Costs | Infrastructure-related capital and operational costs (if any) are affordable for end users. | | |
| Potential Economic or Workforce Impacts to Make Transition | There are no known major negative economic and/or workforce impacts that could potentially result from transitioning to the new equipment. | | |
| Existence and Sustainability of Financing to Improve Cost of Ownership | Financing mechanisms, including incentives, are in place to help end users with incremental vehicle costs and/or new infrastructure-related costs, and are likely remain available over the next several years. | | |
| Legend: Economic Workability (2018) | | | |
| Source: based on preliminary OEM survey responses, OEM product information, various government sources, and Tetra Tech team’s industry knowledge. | | | |

NZE Natural Gas ICE – While natural gas drayage trucks have higher incremental purchase prices, their cost of ownership over a 12-year vehicle lifetime is similar to that of new diesel trucks. The cost of ownership and payback of the higher incremental purchase price is driven primarily by lower fuel costs. Today’s fuel price spreads between diesel and CNG provide the necessary fuel cost savings to recover the higher incremental purchase price. However, cost of ownership is sensitive to this price spread and actual cost savings could change significantly as price spreads change.

Infrastructure costs are generally covered by the assumed fuel prices in this analysis. However, fleets that choose to construct their own fueling stations may ultimately realize lower fuel prices and a return on investment relative to public access stations. Maintenance and support for privately owned stations are available through service contracts to third parties or may be taken on by the station owner.

Because the majority of drayage truck operators are assumed to rely on third parties to perform significant repairs that might require specialized maintenance facilities and tools, it is assumed that dealer networks and repair facilities will make the required investments (or have already made those investments) to service trucks.

Incentives remain an important but uncertain part of improving the cost of ownership for natural gas vehicles such that they become significantly less expensive to operate than diesel trucks, even as fuel price spreads change. Currently available purchase incentives achieve this goal and fuel credits through the LCFS and federal RFS allow natural gas stations to offer fossil natural gas or renewable natural gas at equivalent prices. However, the long-

2018 Feasibility Assessment for Drayage Trucks –
Section 9: Assessment of Economic Workability

term availability of these incentives is not guaranteed. Additionally, there are insufficient funds in current purchase incentive programs to provide incentives for more than a small fraction of the total drayage fleet.

ZE Battery-Electric – Battery-electric trucks have roughly two to three times greater purchase prices relative to new diesel trucks. These higher incremental costs can be offset by lower fuel and maintenance costs, but cost of ownership is dependent on the realized electricity cost for a fleet. The effective cost of electricity is dependent on numerous factors and substantial differences in cost exist based on the utility serving a particular location. These differences lead to a broad range of battery-electric truck cost of ownership results. Cost of ownership may be comparable to diesel, or may be substantially greater than diesel based solely on the utility rate available to the fleet. Additionally, maintenance cost savings are currently highly speculative until ongoing demonstrations provide more robust data on which to refine estimates.

Because the majority of drayage truck operators are assumed to rely on third parties to perform significant repairs that might require specialized maintenance facilities and tools, it is assumed that dealer networks and repair facilities will make the required investments (or already have made those investments) to service trucks.

Incentives currently available to battery-electric trucks can dramatically alter the cost of ownership relative to diesel trucks. Purchase incentives combined with credits through the LCFS program can reduce cost of ownership to 25-40% that of diesel trucks. Unfortunately, the long-term availability of these incentives is not guaranteed. Additionally, there are insufficient funds in current purchase incentive programs to provide incentives for more than a small fraction of the total drayage fleet. (Perhaps more importantly, the incremental weight of battery-electric trucks restricts their applicability within drayage, as described in the Operational Feasibility section.) However, where battery-electric drayage trucks can meet operational requirements, current incentives make these trucks dramatically less expensive to operate than diesel trucks.

10. Findings and Conclusions for 2018 Feasibility Assessment for Drayage Trucks

10.1. Summary of the Assessment’s Scope, Methodology and Breadth of Application

This 2018 Feasibility Assessment for Drayage Trucks applied five key parameters to examine which (if any) emerging zero-emission (ZE) and/or near-zero-emission (NZE) fuel-technology platforms for Class 8 trucks are demonstrably capable of, and ready for, broad deployment in revenue drayage service at the two Ports, in 2018 or within approximately three years.

The five parameters applied to qualitatively and collectively assess overall feasibility were as follows:

- Commercial Availability
- Technical Viability
- Operational Feasibility
- Availability of infrastructure and Fuel
- Economic Workability (Key Economic Considerations and Issues)

Two of these feasibility parameters – commercial availability and technical viability – were used to initially screen five core ZE and NZE fuel-technology platforms that appear to hold the most promise to power large numbers of Class 8 drayage trucks today, or by 2021. Those fuel-technology platforms that were shown to meet basic considerations for these two parameters today (or within a three-year timeframe) were then further assessed by applying the three remaining feasibility parameters (operational feasibility, infrastructure availability and economic workability).

2018 Feasibility Assessment for Drayage Trucks –
Section 10: Findings and Conclusions for 2018 Feasibility Assessment for Drayage Trucks

10.2. Summary of Findings: Commercial Availability

As summarized below, two ZE or NZE fuel-technology platforms are sold (as of late 2018) by OEMs in commercially available Class 8 trucks suitable for drayage. The table below restates the findings on commercial availability. This is followed by a brief summary of the main findings.

Table 39. Summary of findings for 2018 Commercial Availability

| Commercialization Criteria | Base Considerations | Assessment of Criteria Achievement in 2018 by Leading ZE and NZE Fuel-Technology Drayage Truck Platforms | | | | |
|--|---|--|--------------|---------------------|------------|----------------|
| | | ZE Battery-Electric | ZE Fuel Cell | NZE Hybrid Electric | NZE NG ICE | NZE Diesel ICE |
| Production and Sales with Major OEM Involvement | Production and full certification by either a major Class 8 truck OEM, or by a proven technology provider that has partnered with the major OEM. | | | | | |
| Proven Network / Capabilities for Sales, Support and Warranty | Demonstrated existing (or near-term planned) network of sufficient dealerships to sell, service, warranty and provide parts for all commercially deployed drayage trucks. | | | | | |
| Sufficient Means and Timeline for Production | Demonstrated capability to manufacture sufficient numbers of Class 8 trucks (suitable for drayage) within timeline to meet existing or expected demand. | | | | | |
| Existence of Current and/or Near-Term Equipment Orders | Demonstrated backlog of orders, or credible expression of interest from prospective customers to submit near-term orders. | | | | | |
| Legend: Commercial Availability (2018) | | | | | | |
| Source of Ratings: based on OEM survey responses, OEM product information, various government sources, and consultant's industry knowledge. | | | | | | |

- **ZE** battery-electric technology is commercially offered in a drayage-capable Class 8 truck by a single company, start-up OEM BYD. This is effectively a “pre-commercial” or “early commercial” launch, as BYD has just recently entered into this challenging market with its 8TT model. To date, fewer than five (possibly only one) 8TT have been deployed in drayage service.
- **NZE** natural gas ICE technology is the dominant commercially available Class 8 truck platform powered by a ZE or NZE system. All six mainstream OEMs are offering Class 8 NZE trucks powered by the 12-liter Cummins Westport ISX12N engine.

The other three core fuel-technology platforms did not meet the basic criteria and considerations to be deemed commercially available in late 2018, nor do they appear on that path by 2021.

Heavy-duty vehicle OEMs have significantly accelerated their efforts to develop and commercialize ZE and NZE trucks, including Class 8 platforms suitable for port drayage service. These emerging alternative fuel Class 8 truck platforms are in various stages of technological and commercial maturity. So far, none are able to match the full package of attributes provided by conventional Class 8 diesel trucks. Only one platform, natural gas ICE, has emerged as a mainstream commercial option offered by all the mainstream Class 8 truck OEMs. However, even

2018 Feasibility Assessment for Drayage Trucks –
Section 10: Findings and Conclusions for 2018 Feasibility Assessment for Drayage Trucks

this NZE natural gas platform has not yet been fully demonstrated in the rigorous and challenging duty cycles found in San Pedro Bay port drayage.

This points to the essential role that early commercial and pre-commercial demonstrations must play over the next few years, to expedite sustainable commercialization and wide deployment of ZE and NZE drayage trucks.

10.3. Summary of Findings: Technical Viability

Technical Viability is the second of two parameters used in this study to screen the five core fuel-technology platforms for overall feasibility. The rationale for this screening procedure is straightforward. Until a particular fuel-technology platform 1) has achieved (or is approaching) the minimum threshold for technical viability, and 2) has become (or can soon become) a fully certified product offered by a major Class 8 truck OEM, it is premature to evaluate potential for broad-scale deployment in the San Pedro Bay drayage fleet by 2021.

To assess technical viability using common and established metrics, snapshot TRL ratings were assigned to each of the five core emerging ZE and NZE platforms. It was found that two fuel-technology platforms **ZE battery-electric** and **NZE natural gas ICE** – the same two found to meet the test for commercial availability -- have demonstrated sufficient levels of technology readiness to be considered technically viable for near-term deployment in Class 8 drayage service at the San Pedro Bay Ports. The table below summarizes these findings.

Table 40: Summary of findings for 2018 Technical Viability and 2021 prognoses

| TRL | Relative Stage of Development | Late-2018 TRLs for Leading Fuel-Technology Platforms (Drayage) | ~2021: Educated Prognoses (by or before) | Comments / Basis for 2021 Educated Prognosis |
|-------|-------------------------------|--|--|---|
| TRL 9 | Systems Operations | | NZE NG ICE (TRL 9) | NZE NG ICE: to reach TRL 9 in Class 8 port drayage, new NZE 12-liter engine <u>needs operational time</u> |
| TRL 8 | Systems Conditioning | NZE NG ICE (TRL 8) | ZE Battery (TRL 8) | ZE Battery Electric: strong progress in transit bus / MDV sectors is likely to advance Class 8 drayage use; ongoing range challenge may <u>limit</u> to short-haul applications |
| TRL 7 | | ZE Battery (TRL 6 to 7) | ZE Fuel Cell or NZE Plug-in Hybrid (TRL 7??) | ZE Fuel Cell: biggest remaining hurdles relate to total cost of ownership, including access to / on-board storage of hydrogen fuel; NZE Plug-in Hybrid: prognosis is a wild card; OEM interest is hard to gauge, but plug-in architecture enables valued "zero-emission mile" capability |
| TRL 6 | Technology Demonstration | ZE Fuel Cell or NZE Plug-in Hybrid (TRL 5 to 6) | NZE Diesel ICE (TRL 5, or higher?) | NZE Diesel ICE: could "leapfrog" to TRL 8 or 9, but <u>only if</u> suitable diesel engine(s) get certified to 0.02 g/bhp-hr NOx (or other CARB OLSN) |
| TRL 5 | Technology Development | NZE Diesel ICE (TRL 5) | | |
| TRL 4 | | | | |

Source: TRL methodology adapted from U.S. DOE, "Technology Readiness Assessment Guide, Table 1: Technology Readiness Levels, September 2011 (see footnote). TRL ratings estimated based on input from 1) OEM surveys, 2) various technical reports, 3) demonstration activities, and 4) meetings with agency technical personnel (CARB, CEC, SCAQMD).

2018 Feasibility Assessment for Drayage Trucks –
Section 10: Findings and Conclusions for 2018 Feasibility Assessment for Drayage Trucks

As described above, **only two fuel-technology platforms meet the above tests for both Commercial Availability and Technical Viability: 1) ZE battery-electric and 2) NZE natural gas ICE.** Consequently, the remainder of this 2018 Assessment was focused on further characterizing feasibility for these two platforms according to the remaining three parameters (Operational Feasibility, Infrastructure Availability, and Economic Workability).

10.4. Summary of Findings: Operational Feasibility

Results of the Operational Feasibility analysis are summarized below for the two Class 8 platforms that were determined to be commercially available and technically viable (as of late 2018): **ZE** battery-electric and **NZE** natural gas ICE. OEMs have significantly improved both types of platforms over the last year, in terms of their ability to meet the tough operational needs of San Pedro Bay drayage fleets. The table below summarizes these findings.

Table 41. Summary of findings for 2018 Operational Feasibility

| Operational Feasibility Criteria / Parameter | Base Considerations for Drayage Platforms to Achieve Operational Feasibility | Achievement of Criteria in 2018 for Commercially Available Drayage Truck Platforms | |
|---|--|--|------------|
| | | ZE Battery-Electric | NZE NG ICE |
| Basic Performance | Demonstrated capability to meet drayage company needs for basic performance parameters including power, torque, gradeability, operation of accessories, etc. | | |
| Range | Demonstrated capability to achieve per-shift and daily range requirements found in San Pedro Bay drayage. | | |
| Speed and Frequency of Refueling / Recharging | Demonstrated capability to meet drayage company needs for speed and frequency to refuel / recharge such that revenue operation is not significantly reduced relative to diesel baseline. | | |
| Driver Comfort, Safety, and Refueling Logistics | Proven ability to satisfy typical drayage trucking company's needs for comfort, safety and refueling procedures. | | |
| Availability of Replacement Parts and Support for Maintenance / Training | Verifiable existence of and timely access (equivalent to baseline diesel) to all replacement parts needed to conduct scheduled and unscheduled maintenance procedures. | | |
| | Verifiable existence of maintenance procedure guidelines and manuals, including OEM-provided training courses upon purchase and deployment of new trucks. | | |
| Legend: Operational Feasibility (2018) | | | |
| Source: Based on Drayage Truck Operator Survey responses, footnoted studies, OEM product information, and consultant's industry knowledge. | | | |

- **ZE** battery-electric trucks outperform diesel trucks in terms of power, torque, and gradeability, but are currently only applicable to a subset of drayage operations due to limitations on vehicle range, weight, and recharging times. Questions remain as to the adequacy of the service supply chain
- **NZE** natural gas trucks are the closest direct replacement for diesel trucks in terms of operational feasibility. Basic performance metrics, range, fueling frequency and speed, driver comfort and safety, and maintenance

2018 Feasibility Assessment for Drayage Trucks –
Section 10: Findings and Conclusions for 2018 Feasibility Assessment for Drayage Trucks

support are generally comparable to diesel trucks. Maintenance support is expected to be scalable with increased deployments of natural gas trucks through the use of existing truck and engine dealerships.

10.5. Summary of Findings: Infrastructure Availability

With the development ZE and NZE platforms progressing quickly, infrastructure has emerged as one of the most significant near-term barriers to wide-scale adoption of these technologies. Results of the infrastructure availability analysis are summarized below for the two ZE or NZE fuel-technology platforms determined to be commercially available and technically viable for Class 8 truck platforms suitable for drayage.

Table 42. Summary of findings for 2018 Infrastructure Availability

| Infrastructure Criteria / Parameter | Base Considerations for Assessing Infrastructure Availability | Achievement of Criteria for Remaining Drayage Truck Platforms | |
|---|--|---|------------|
| | | ZE Battery-Electric | NZE NG ICE |
| Dwell Time at Station | Refueling/recharging can be accommodated within typical work breaks, lunches, other downtime compatible with trucking company schedules and operational needs. | | |
| Station Location and Footprint | Fleets have existing onsite access to fueling infrastructure, or can be fueled/charged conveniently and affordably off site, at public or private stations. New infrastructure can be installed without extensive redesign, reconfiguration or operational disruptions and there is sufficient electrical or natural gas capacity at the site. | | |
| Infrastructure Buildout | Infrastructure can be constructed at a pace consistent with fleet adoption and able to meet fleet fueling/charging requirements by the end of the assessment period. | | |
| Existence of / Compatibility with Standards | A sufficient body of codes and standards exist from appropriate organizations that enables safe and effective refueling/recharging. The refueling/recharging station technology has already been installed at other trucking companies in the U.S., with sufficient time to assess performance and safety. | | |
| <p>Legend: Infrastructure Availability (2018)</p> | | | |
| <p>Source: based on preliminary OEM survey responses, OEM product information, various government sources, and Tetra Tech team's industry knowledge.</p> | | | |

- **ZE** battery-electric truck charging infrastructure is a rapidly changing landscape. Substantial progress has been made toward standardization, but competing standards remain and no clear winner has emerged. Charging infrastructure has the potential to be deployed at fleet yards, enabling overnight charging for a significant fraction of the fleet. However, much of the fleet is likely to remain dependent on centralized, public access infrastructure for which battery-electric charging infrastructure has yet to offer a comparable solution.
- **NZE** natural gas trucks rely on well-known and proven fueling infrastructure currently in use in many heavy-duty applications. Due to this long history, standards are well-known and the industry largely adheres to a single set of compatible fuel system designs that ensure broad interoperability between vehicles and stations. Fueling times are typically longer than diesel but do not appear impractical. Where time-fill strategies are applicable, fueling times are not a barrier. Public fast-fill fueling similar to diesel is

2018 Feasibility Assessment for Drayage Trucks –
Section 10: Findings and Conclusions for 2018 Feasibility Assessment for Drayage Trucks

also possible and needed to support much of the drayage fleet’s current operations. The ability to build the required infrastructure at the pace needed to fully support the drayage fleet by 2021 remains in doubt.

10.6. Summary of Findings: Economic Workability

The drayage truck sector is generally a low-margin, low-asset base sector. Technologies that can provide a cost of ownership similar to, or better than, diesel are needed. Results of the economic workability analysis are summarized below for the two ZE or NZE fuel-technology platforms determined (as of late 2018) to be commercially available and technically viable Class 8 truck platforms suitable for drayage.

Table 43. Summary of findings for 2018 Economic Workability

| Economic-Related Criteria / Issue | Base Considerations for Assessing General Economic Workability | Achievement of Criteria in 2018 (Commercially Available Truck Platforms) | |
|--|--|--|------------|
| | | ZE Battery-Electric | NZE NG ICE |
| Incremental Vehicle Cost | The upfront capital cost for the new technology is affordable to end users, compared to the diesel baseline. | | |
| Fuel and Other Operational Costs | The cost of fuel / energy for the new technology is affordable, on an energy-equivalent basis (taking into account vehicle efficiency). Demand charges / TOU charges (if any) are understood and affordable. Net operational costs help provide an overall attractive cost of ownership. | | |
| Infrastructure Capital and Operational Costs | Infrastructure-related capital and operational costs (if any) are affordable for end users. | | |
| Potential Economic or Workforce Impacts to Make Transition | There are no known major negative economic and/or workforce impacts that could potentially result from transitioning to the new equipment. | | |
| Existence and Sustainability of Financing to Improve Cost of Ownership | Financing mechanisms, including incentives, are in place to help end users with incremental vehicle costs and/or new infrastructure-related costs, and are likely remain available over the next several years. | | |
| Legend: Economic Workability (2018) | | | |
| Source: based on preliminary OEM survey responses, OEM product information, various government sources, and Tetra Tech team’s industry knowledge. | | | |

- **ZE** battery-electric trucks have substantially higher upfront capital costs and require significant investments in infrastructure. Fuel and maintenance savings can reduce the impact of the higher capital cost but do not make the total cost of ownership comparable to diesel trucks on a net present value basis. These comparisons are dependent on the realized cost of electricity to the truck operator. Because these costs vary by location, fleets will see significantly different cost of ownership relative to diesel depending on where the trucks are charged. Current incentives can dramatically reduce cost of ownership of electric

2018 Feasibility Assessment for Drayage Trucks –
Section 10: Findings and Conclusions for 2018 Feasibility Assessment for Drayage Trucks

trucks, making them much less expensive to operate than diesel trucks. However, the long-term availability and value of these incentives is uncertain.









- **NZE** natural gas trucks have higher upfront capital costs but an overall cost of ownership comparable to diesel trucks. These comparisons are sensitive to changes in the fuel price spread between diesel and natural gas, creating some risk to the return on the higher capital cost of natural gas trucks. Incentives can improve the cost of ownership comparison, but the long-term availability and value of these incentives is uncertain.

10.7. Conclusion: 2018 Feasibility per All Five Key Parameters

Table 44 summarizes the relative degree to which the two commercially available and technically viable fuel-technology platforms achieve each of the five key feasibility parameters today, in the specific context of drayage service for the San Pedro Bay Ports. This is followed by additional discussion about the ratings.

NOTE: The ratings for overall achievement of each five feasibility parameter (see the table below) are based on the analysis of several criteria within that parameter. Because each criterion is important for the success of a given fuel-technology platform in drayage, the overall achievement ratings are based on the lowest criterion score for each feasibility parameter.

Table 44. Summary of 2018 overall feasibility (all five key parameters)

| Feasibility Parameter / Criteria | Overall Achievement* of Criteria in 2018 (Commercially Available / Technically Viable Truck Platforms) | |
|--|---|---|
| | ZE Battery-Electric | NZE NG ICE |
| Commercial Availability |  |  |
| Technical Viability | TRL 6 to 7 (moving to 7 or 8) | TRL 8 (moving to 9) |
| Operational Feasibility |  |  |
| Infrastructure Availability |  |  |
| Economic Workability |  |  |
| Legend: Achievement of Each Noted Parameter / Criteria (2018)  | | |
| <p>*These ratings for overall achievement of each five feasibility parameter are based on the analysis of several criteria within that parameter. Because each criterion is important for the success of a given fuel-technology platform in drayage, the overall achievement ratings are based on the <u>lowest</u> criterion score for each feasibility parameter.</p> | | |

2018 Feasibility Assessment for Drayage Trucks –
Section 10: Findings and Conclusions for 2018 Feasibility Assessment for Drayage Trucks

ZE Battery-Electric Trucks

- **Commercial Availability:** Class 8 ZE battery-electric trucks are essentially pre-commercial or early commercial products for drayage service at the San Pedro Bay Ports. One basic OEM-backed model is commercially offered today; it meets the base criteria and considerations for this category, albeit for niche use in shorter-haul drayage applications. Most if not all of the mainstream OEMs are working on Class 8 battery-electric tractors suitable for drayage, and additional commercialized products are expected by the 2021-2022 timeframe.
- **Technical Viability:** Class 8 ZE battery-electric tractors are rated at TRL 7 today. The prognosis is that they may achieve TRL 8 by 2021. Mainstream OEMs likely will not sell battery-electric tractors as commercial products, unless and until this is achieved. Over the next two years it will be essential for Class 8 battery-electric trucks to prove their operational feasibility in San Pedro Bay drayage service, through the many demonstrations that are now beginning (or will soon be commissioned).
- **Operational Feasibility:** Class 8 ZE battery-electric trucks offer equivalent or better performance compared to diesel, but they currently have range and weight limitations that substantially restrict their applicability to certain drayage niches.
- **Infrastructure Availability:** Class 8 ZE battery-electric trucks require major investments in charging infrastructure throughout Southern California. Many trucks will likely rely on fast-charge networks, which to date have not demonstrated practical solutions for public access stations. It is extremely unlikely that sufficient charging infrastructure could be constructed by 2021 to support electrification of a large portion of the drayage fleet.
- **Economic Workability:** Class 8 ZE battery-electric trucks are currently cost competitive with diesel trucks only with substantial incentives. Favorable utility rate structures can significantly improve total cost of ownership, but are not sufficient by themselves to make battery-electric drayage trucks cost competitive with diesel trucks.

NZE Natural Gas Trucks

- **Commercial Availability:** Class 8 NZE natural gas trucks are fully commercial today, from multiple mainstream truck OEMs. They meet all of the base criteria and considerations for this category.
- **Technical Viability:** Class 8 NZE natural gas trucks are rated at TRL 8 today, and the prognosis is that they will achieve TRL 9 by 2020. The technology is robust and proven in Class 8 trucking applications, but more operational experience is needed in the specific drayage duty cycles found at the San Pedro Bay Ports.
- **Operational Feasibility:** Class 8 NZE natural gas trucks are capable of performing much of the work of diesel drayage trucks. Very heavy loads, combined with steep grades, are likely to remain challenging for current natural gas engines.
- **Infrastructure Availability:** Class 8 NZE natural gas trucks can take advantage of existing fueling infrastructure in the ports and around Southern California. However, a substantially larger infrastructure network will need to be constructed to support a full transition to natural gas drayage trucks. The ability to deploy this infrastructure quickly remains in doubt.
- **Economic Workability:** Class 8 NZE natural gas trucks are cost competitive with diesel at today's fuel price spreads, for the average drayage fleet. Government incentives further improve their economic competitiveness.

10.8. Looking Forward: ZE Commercial and Technological Outlook for Post-2021

As described in this report, all of the major truck OEMs and many new market entrants are developing ZE truck platforms. Of particular importance is that several major Class 8 truck OEMs plan to begin offering ZE battery-electric Class 8 trucks by 2021. Examples of announcements by major Class 8 truck OEMs regarding ZE battery-electric truck offerings in the 2021 timeframe (and beyond) include the following:

- Daimler Trucks reportedly plans to enter into full-scale production of its Class 8 BE e-Cascadia truck by 2021. Daimler will specifically target its e-Cascadia model for local and regional trucking applications including drayage. Such shorter-range applications are conducive to the current energy density (range) limitations of battery technology.
- Navistar has announced its intention to commercialize and sell large numbers of battery-electric Class 8 trucks by 2025, although Navistar has not yet provided vehicle specifications.
- Volvo intends to sell battery-electric heavy-duty trucks in North America after an initial (2019) launch in Europe. Prior to a corresponding commercial launch for North America, Volvo will conduct a major demonstration of Class 8 battery-electric trucks at the San Pedro Bay Ports, starting in 2019 (refer back to Section 5.6). Thus, it appears that Volvo’s potential North American commercial launch of Class 8 battery-electric trucks will occur in the 2021-to-2022 timeframe.
- Tesla has announced plans to commercialize a high-performance, long-range battery-electric tractor that – if able to achieve the claimed performance and cost metrics – could fundamentally improve the broad feasibility of ZE battery-electric platforms in drayage.

Similarly, strong progress is being made to build, test and eventually mass-manufacture Class 8 trucks powered by ZE hydrogen fuel cell systems. Equally important, HDV end user fleets (transit properties, primarily) are gaining important experience building out hydrogen fueling stations, which has the potential for technology transfer into Class 8 trucking applications. The reality is that Class 8 tractors incorporating hydrogen fuel cell technology are just beginning to be developed and demonstrated in drayage duty at the Ports. Nonetheless, there are important OEM-backed activities to demonstrate (and possibly commercialize) Class 8 fuel cell trucks over the next several years, including the following:

- Start-up OEM Nikola Motors is testing two different hydrogen fuel cell tractor models, and has received thousands of preliminary orders from major Class 8 trucking fleets for their purchase. Nikola has not yet provided specifics about production dates, costs, or final specifications, although it appears that mass production will be well-underway no later than 2025.
- Toyota’s decision to design and test heavy-duty hydrogen fuel cell powertrains for Class 8 drayage trucks could significantly add to commercial options for heavy-duty hydrogen fuel cell platforms. Toyota has stated that this is the heavy-duty “powertrain of the future”¹¹⁷ for on-road goods movement. Toyota already has extensive experience commercializing hydrogen fuel cell systems for light-duty vehicles, and it owns HDV OEM Hino.
- Kenworth (in conjunction with Toyota) is working to develop and eventually commercialize Class 8 trucks powered by hydrogen fuel cell technology.

¹¹⁷ “Toyota Opens a Portal to the Future of Zero Emission Trucking,” Toyota Newsroom, April 19, 2017, <https://corporatenews.pressroom.toyota.com/releases/toyota+zero+emission+heavyduty+trucking+concept.htm>

2018 Feasibility Assessment for Drayage Trucks –
Section 10: Findings and Conclusions for 2018 Feasibility Assessment for Drayage Trucks

In summary, all the OEMs (existing and start-up) appear to be developing Class 8 tractors with ZE architectures. They will achieve true commercialization on timelines that are commensurate with commercial maturity and according to what makes good business sense. Over the next three years, if at least some of these OEMs are able to achieve their stated goals on performance and cost metrics – and very critical infrastructure build-outs can move forward in proportion to vehicle rollouts – this will fundamentally improve the commercial availability and broad feasibility of ZE platforms in drayage trucking.

11. Appendix A: Criteria for Acceptable Data Sources

The following table summarizes the general types of data sources that are considered “acceptable” to use, as well as those types considered to be “unacceptable.”

| Acceptable Information/Data Sources | Unacceptable Information/Data Sources |
|---|---|
| <ul style="list-style-type: none"> • Technical reports, policy documents, and assessments prepared by government agencies with acknowledged fuel-technology expertise • Certification / verification Executive Orders by the California Air Resources Board or the U.S. EPA • Peer-reviewed journal articles • Industry trade group data, with sources • Technology demonstration reports prepared by equipment manufacturers, end users, and/or funding agencies • Official commercial product announcements and detailed product datasheets • Technical reports and whitepapers prepared by subject matter experts • Presentations from manufacturers and end users describing experience and/or analysis of relevant technologies and market dynamics • Material deemed to be credible, verifiable, technical, and relevant by Port representatives and/or TAP advisors | <ul style="list-style-type: none"> • Unsourced reports • Personal accounts or anecdotes (unless provided by individuals verified to be involved in an official capacity with activities listed in the “Acceptable” column of this table) • Policy advocacy documents without verifiable data/sources to support claims • Fuel additives and/or devices that have not been fully evaluated and Verified by CARB, including a multimedia evaluation • Material that is deemed <u>NOT</u> to be credible, verifiable, technical, and/or relevant by Port CAAP representatives and/or TAP advisors |

12. Appendix B: Summary of Relevant Incentive Programs

12.1. HVIP Program

The HVIP program offers incentives for the purchase of new heavy-duty vehicles using hybrid, electric, or natural gas technologies. Funding is provided through the State’s Greenhouse Gas Reduction Fund (GGRF). Current funds available in the program total \$67 million. The 2018 funding plan will add an additional \$125 million to the program’s available funding.¹¹⁸ Annual award totals are not capped, but CARB staff anticipate that the current funding allocations will meet demand for several years.

The maximum voucher amount available to battery-electric Class 8 trucks is \$150,000, or \$165,000 for trucks deployed in disadvantaged communities. Given the operating regions for drayage trucks, it is reasonable to assume that many trucks would qualify for the \$165,000 voucher amount. HVIP also offers incentives for charging infrastructure but has noted, “...infrastructure installation is a complex issue with long lead times, which is incongruous with HVIP’s simplified approach, and statutory expenditure deadlines.”¹¹⁹ Staff have proposed to continue infrastructure funding through 2018/2019 and reevaluate the funding for the 2019/2020 funding year. Given this uncertainty, it is not assumed that truck buyers would have access to infrastructure incentives through HVIP. HVIP also provides up to \$45,000 for the purchase of 12L near-zero natural gas engines, when paired with renewable natural gas. Fleets of 10 or fewer vehicles are exempt from RNG usage requirements.

12.2. Low Carbon Fuel Standard

California’s Low Carbon Fuel Standard allows producers of alternative fuels to generate credits based on the lifecycle GHG emissions reductions of the alternative fuel relative to established diesel and gasoline benchmarks. These credits can have substantial value. CARB’s most recent transaction data report a price of \$171 per credit for the month of September, 2018. One credit is equal to one metric ton of GHG emissions reductions. Considering that a diesel drayage truck travelling 68,000 miles per year produces 155 MT of GHG emissions on a fuel lifecycle basis, the potential credit value associated with reducing a substantial fraction of those emissions through the use of electricity or RNG would be tens of thousands of dollars per year.

CARB recently adopted revisions to the LCFS program that will go into effect January 1, 2019. The program currently requires a 10% reduction in the carbon intensity of the transportation fuel pool by 2020 relative to a 2010 baseline. These revisions extended carbon intensity requirements for diesel and gasoline fuels, requiring a 20% reduction from the 2010 baseline by 2030. This change is expected to significantly increase the number of deficits generated by producers and importers of traditional gasoline and diesel fuel, thereby increasing demand for credits to offset the additional deficits. However, the modifications to the LCFS program also significantly expand the potential number of generators of credits and increase the number of credits that can be generated from heavy-duty electric vehicles. These additional credits could act to reduce credit prices, particularly as current credit prices near the approximately \$200/credit price cap established in the regulation.

Despite uncertainty in the future of credit prices under the LCFS program, LCFS credit values are assumed to be \$149 per MT, calculated from the weighted average credit price for the first three quarters of credit transfer pricing reported by CARB.¹²⁰

¹¹⁸ <https://www.arb.ca.gov/regact/nonreg/2018/fundingplan/cleantransportation2018.pdf>

¹¹⁹ https://www.arb.ca.gov/msprog/aqip/fundplan/proposed_1819_funding_plan.pdf

¹²⁰ California Air Resources Board, “Monthly LCFS Credit Transfer Activity Report for September 2018.” Posted October 9, 2018. https://www.arb.ca.gov/fuels/lcfs/credit/20181009_sepcreditreport.pdf

2018 Feasibility Assessment for Drayage Trucks –
Section 12: Appendix B: Summary of Relevant Incentive Programs

12.3. VW Mitigation Trust Funds

The Volkswagen Environmental Mitigation Trust will provide \$423 million to the State to fund emission reductions projects under the State’s Beneficiary Mitigation Plan. This plan allocates \$90 million in funds for zero-emission Class 8 freight and port drayage trucks. An initial allocation of \$27 million has been approved for this project category and will fund up to \$200,000 for the replacement of a 2012 or older diesel truck with a zero-emission truck. Subsequent allocations, up to the programmed \$90 million total, will be released in subsequent years and incentive amounts may be reduced as incremental costs of zero-emission trucks decrease.¹²¹ Note that while it is possible to combine incentives between certain programs (such as HVIP and the VW mitigation trust), these programs have limitations on the percentage of the vehicle cost that can be funded. For example, HVIP limits funding from all public sources to 90% of the total vehicle cost, while the VW Beneficiary Plan limits VW funding to 75% of the total vehicle cost.

12.4. Southern California Edison’s Charge Ready Transport Program

SCE has received approval from the California Public Utilities Commission to install electric infrastructure at customer sites to support charging of heavy-duty vehicles, including buses, medium and heavy-duty trucks, forklifts, and cargo handling equipment. The program also allows SCE to offer rebates to customers for the purchase of charging stations. This program has been authorized for up to \$343 million to support 870 sites and at least 8,490 vehicles. A minimum of 25% of funds, and up to 75% of funds could be available for heavy-duty trucks serving the ports and warehouses. This implies that between \$86 million and \$257 million would be available for infrastructure development. The program is currently under development and details on funding allocations and per-site or per-charger funding limits have not been released. This program differs from the other funding programs described above as it provides funding only for charging infrastructure and does not fund vehicle purchases.

¹²¹ California Air Resources Board, “Beneficiary Mitigation Plan for the Volkswagen Environmental Mitigation Trust” June, 2018. https://www.arb.ca.gov/msprog/vw_info/vsi/vw-mititrust/documents/bmp_jun2018.pdf

2018 Feasibility Assessment for Drayage Trucks –
Appendix C: Truck Operator Survey Questions and Summary of Responses

13. Appendix C: Truck Operator Survey Questions and Summary of Responses

The following tables summarize the results received to the Truck Operator Survey that ran from September 3, 2018 through September 25, 2018. Calculated fields used in this Assessment are also provided and identified as such.

| Question | Survey Results | | | | | | | |
|----------|----------------|--|--|--|--|--|--|--|
|----------|----------------|--|--|--|--|--|--|--|

1 How many Class 8 trucks do you operate/dispatch in Southern California (including trucks operated by contractors)?

| Less than 10 | 10-25 | 25-50 | 50-100 | 100-250 | 250-500 | >500 | Responses | Response Rate |
|--------------|-------|-------|--------|---------|---------|------|-----------|---------------|
| 41 | 22 | 14 | 9 | 9 | 2 | 0 | 97 | 100% |

2 Of your trucks that operate in Southern California, please indicate the percentage of trucks whose service includes at least some drayage to/from the Ports.

| 0-20% | 20-40% | 40-60% | 60-80% | 80-100% | Responses | Response Rate |
|-------|--------|--------|--------|---------|-----------|---------------|
| 7 | 2 | 3 | 5 | 80 | 97 | 100% |

3 Of your trucks that operate in Southern California, please indicate the percentage of trucks whose service is exclusively providing drayage to/from the Ports.

| 0-20% | 20-40% | 40-60% | 60-80% | 80-100% | Responses | Response Rate |
|-------|--------|--------|--------|---------|-----------|---------------|
| 14 | 2 | 1 | 8 | 72 | 97 | 100% |

2018 Feasibility Assessment for Drayage Trucks –
Section 13: Appendix C: Truck Operator Survey Questions and Summary of Responses

| Question | Survey Results |
|----------|----------------|
|----------|----------------|

4 What is the average fuel economy of port trucks that you dispatch (in miles/gallon)?

| Less than 4 mpg | 4 to 5 mpg | 5 to 6 mpg | 6 to 7 mpg | 7 to 8 mpg | More than 8 mpg | Responses | Response Rate |
|-----------------|------------|------------|------------|------------|-----------------|-----------|---------------|
| 6 | 4 | 27 | 32 | 20 | 7 | 96 | 99% |

| Average MPG | | Average MPG - Used | | Average MPG - New | |
|-------------|-----|--------------------|------|-------------------|------|
| Min | 3.5 | Min | 3.5 | Min | 3.5 |
| Max | 8.5 | Max | 8.5 | Max | 8.5 |
| Average | 6.3 | Average | 6.42 | Average | 6.35 |
| Avg. Wghtd. | 6.0 | Avg. Wghtd. | 5.98 | Avg. Wghtd. | 5.98 |
| Mode | 6.5 | Mode | 6.5 | Mode | 6.5 |
| Std Dev | 1.2 | Std Dev | 1.2 | Std Dev | 1.1 |
| Responses | 96 | Responses | 48 | Responses | 40 |

5 What is the typical annual maintenance/repair cost of port trucks that you dispatch?

All Trucks

| | |
|-------------|-----------|
| Min | \$ 1,500 |
| Max | \$ 30,000 |
| Average | \$ 9,123 |
| Mode | \$ 5,000 |
| Avg. Wghtd. | \$ 8,208 |
| Std Dev | \$ 5,806 |

Primarily Purchases Used Trucks

| | |
|-------------|-----------|
| Min | \$ 1,500 |
| Max | \$ 30,000 |
| Average | \$ 9,250 |
| Mode | \$ 5,000 |
| Avg. Wghtd. | \$ 20,000 |
| Std Dev | \$ 6,525 |

Primarily Purchases New Trucks

| | |
|-------------|-----------|
| Min | \$ 2,000 |
| Max | \$ 20,000 |
| Average | \$ 9,227 |
| Mode | \$ 15,000 |
| Avg. Wghtd. | \$ 8,632 |
| Std Dev | \$ 5,051 |

2018 Feasibility Assessment for Drayage Trucks –
Section 13: Appendix C: Truck Operator Survey Questions and Summary of Responses

| Question | Survey Results |
|----------|----------------|
|----------|----------------|

6 For those trucks serving the port, please provide your best estimates of the following data points for a typical truck.

All Trucks

| | | | | | | | | | | | | Calculated Field | | Calculated Field | |
|----------------------------|-----|-------------------------|-----|----------------------------|-----|--------------------------|------|---|-----|---|-------|------------------------------|------|-----------------------|-------|
| Average mileage per shift: | | Average shifts per day: | | Maximum mileage per shift: | | Average hours per shift: | | Average number of days per week in service: | | Typical Loaded Operating Weight, including cargo (lbs): | | Average Daily Operating Time | | Average Daily Mileage | |
| Min | 12 | Min | 1 | Min | 10 | Min | 8 | Min | 5 | Min | 20000 | Min | 8 | Min | 24 |
| Max | 300 | Max | 2 | Max | 700 | Max | 11.5 | Max | 5 | Max | 93000 | Max | 22 | Max | 600 |
| Average | 143 | Average | 1.3 | Average | 239 | Average | 9.6 | Average | 5.0 | Average | 57158 | Average | 13 | Average | 189 |
| Avg. Wghtd. | 160 | Avg. Wghtd. | 1.5 | Avg. Wghtd. | 304 | Avg. Wghtd. | 9.9 | Avg. Wghtd. | 5.0 | Avg. Wghtd. | 61173 | Avg. Wghtd. | 14.8 | Avg. Wghtd. | 238.0 |
| Mode | 100 | Mode | 1 | Mode | 100 | Mode | 10 | Mode | 5 | Mode | 70000 | Mode | 10 | Mode | 100 |
| Std Dev | 78 | Std Dev | 0 | Std Dev | 153 | Std Dev | 1 | Std Dev | 0.0 | Std Dev | 20051 | Std Dev | 5 | Std Dev | 132 |
| Responses | 75 | | 81 | | 77 | | 70 | | 64 | | 79 | | 68 | | 71 |

All Trucks (continued)

| Calculated Field | | Calculated Field | | Calculated Field | | Calculated Field | | Calculated Field | | Calculated Field | | Calculated Field | |
|------------------------|---------|--------------------------|---------|---------------------------------|---------|--------------------------------|---------|------------------|------|------------------------|-----|-------------------------|------|
| Average Annual Mileage | | Average Maintenance Cost | | Average Maintenance Cost - Used | | Average Maintenance Cost - New | | Avg. kWh/Day | | Avg. kWh/Day - 1 Shift | | Avg. kWh/Day - 2 Shifts | |
| Min | 7,800 | Min | \$ 0.02 | Min | \$ 0.02 | Min | \$ 0.05 | Min | 60 | Min | 75 | Min | 60 |
| Max | 156,000 | Max | \$ 1.54 | Max | \$ 1.54 | Max | \$ 0.72 | Max | 1500 | Max | 750 | Max | 1500 |
| Average | 48,383 | Average | \$ 0.30 | Average | \$ 0.32 | Average | \$ 0.25 | Average | 471 | Average | 343 | Average | 743 |
| Avg. Wghtd. | 68,383 | Avg. Wghtd. | \$ 0.20 | Avg. Wghtd. | \$ 0.22 | Avg. Wghtd. | \$ 0.16 | Avg. Wghtd. | 595 | Avg. Wghtd. | 403 | Avg. Wghtd. | 688 |
| Mode | 26,000 | Mode | \$ 0.38 | Mode | \$ 0.31 | Mode | \$ 0.19 | Mode | 250 | Mode | 250 | Mode | 1000 |
| Std Dev | 34,133 | Std Dev | \$ 0.29 | Std Dev | \$ 0.33 | Std Dev | \$ 0.19 | Std Dev | 329 | Std Dev | 185 | Std Dev | 409 |

2018 Feasibility Assessment for Drayage Trucks –
Section 13: Appendix C: Truck Operator Survey Questions and Summary of Responses

| Question | Survey Results |
|----------|----------------|
|----------|----------------|

6 (cont.) For those trucks serving the port, please provide your best estimates of the following data points for a typical truck.

Primarily Purchases Used Trucks

| | | | | | | | | | | | | Calculated Field | | Calculated Field | |
|----------------------------|-----|-------------------------|-----|----------------------------|-------|--------------------------|------|---|-----|---|-------|-----------------------|-----|-----------------------|-----|
| Average mileage per shift: | | Average shifts per day: | | Maximum mileage per shift: | | Average hours per shift: | | Average number of days per week in service: | | Typical Loaded Operating Weight, including cargo (lbs): | | Average Daily Mileage | | Maximum Daily Mileage | |
| Min | 33 | Min | 1 | Min | 50 | Min | 8 | Min | 5 | Min | 20000 | Min | 33 | Min | 50 |
| Max | 300 | Max | 2 | Max | 700 | Max | 11 | Max | 5 | Max | 92000 | Max | 600 | Max | 800 |
| Average | 138 | Average | 1 | Average | 224 | Average | 9 | Average | 5 | Average | 53138 | Average | 180 | Average | 290 |
| Avg. Wghtd. | 152 | Avg. Wghtd. | 1.3 | Avg. Wghtd. | 235.1 | Avg. Wghtd. | 10.1 | Avg. Wghtd. | 5.0 | Avg. Wghtd. | 59190 | Avg. Wghtd. | 194 | Avg. Wghtd. | 289 |
| Mode | 100 | Mode | 1 | Mode | 100 | Mode | 10 | Mode | 5 | Mode | 70000 | Mode | 100 | Mode | 100 |
| Std Dev | 71 | Std Dev | 0 | Std Dev | 152 | Std Dev | 1 | Std Dev | 0.0 | Std Dev | 19344 | Std Dev | 126 | Std Dev | 223 |
| Responses | 40 | | 42 | | 39 | | 36 | | 37 | | 40 | | 39 | | 38 |

Primarily Purchases New Trucks

| | | | | | | | | | | | | Calculated Field | | Calculated Field | |
|----------------------------|-----|-------------------------|-----|----------------------------|-------|--------------------------|------|---|-----|---|-------|-----------------------|-----|-----------------------|-----|
| Average mileage per shift: | | Average shifts per day: | | Maximum mileage per shift: | | Average hours per shift: | | Average number of days per week in service: | | Typical Loaded Operating Weight, including cargo (lbs): | | Average Daily Mileage | | Maximum Daily Mileage | |
| Min | 12 | Min | 1 | Min | 10 | Min | 8 | Min | 5 | Min | 30000 | Min | 24 | Min | 20 |
| Max | 300 | Max | 2 | Max | 600 | Max | 11.5 | Max | 5 | Max | 93000 | Max | 500 | Max | 800 |
| Average | 148 | Average | 1 | Average | 258 | Average | 10 | Average | 5 | Average | 60686 | Average | 195 | Average | 332 |
| Avg. Wghtd. | 165 | Avg. Wghtd. | 1.5 | Avg. Wghtd. | 356.8 | Avg. Wghtd. | 9.6 | Avg. Wghtd. | 5.0 | Avg. Wghtd. | 61786 | Avg. Wghtd. | 248 | Avg. Wghtd. | 428 |
| Mode | 100 | Mode | 1 | Mode | 350 | Mode | 10 | Mode | 5 | Mode | 80000 | Mode | 100 | Mode | 300 |
| Std Dev | 88 | Std Dev | 0 | Std Dev | 162 | Std Dev | 1 | Std Dev | 0.0 | Std Dev | 20829 | Std Dev | 142 | Std Dev | 221 |
| Responses | 31 | | 36 | | 34 | | 31 | | 25 | | 35 | | 29 | | 32 |

*2018 Feasibility Assessment for Drayage Trucks –
Section 13: Appendix C: Truck Operator Survey Questions and Summary of Responses*

| Question | Survey Results | | | | | | |
|----------|----------------|--|--|--|--|--|--|
|----------|----------------|--|--|--|--|--|--|

7 What percentage of the trucks that you dispatch to the Port of Los Angeles and the Port of Long Beach park at one of your facilities overnight?

| 0-20% | 20-40% | 40-60% | 60-80% | 80-100% | Comments | Total Responses | Response Rate |
|-------|--------|--------|--------|---------|----------|-----------------|---------------|
| 13 | 3 | 7 | 5 | 69 | 12 | 97 | 100% |

8 What percentage of trucks that you dispatch to the Port of Los Angeles and the Port of Long Beach refuel at your facilities?

| 0-20% | 20-40% | 40-60% | 60-80% | 80-100% | Comments | Total Responses | Response Rate |
|-------|--------|--------|--------|---------|----------|-----------------|---------------|
| 52 | 4 | 3 | 4 | 33 | 9 | 96 | 99% |

9 How much space is available at your typical facility for additional fueling/charging infrastructure?

| <500 square feet | 500-2,500 square feet | 2,500-5,000 square feet | 5,000-10,000 square feet | >10,000 square feet | Comments | Total Responses | Response Rate |
|------------------|-----------------------|-------------------------|--------------------------|---------------------|----------|-----------------|---------------|
| 51 | 18 | 2 | 6 | 8 | 14 | 85 | 88% |

10 If you own some or all of your trucks, do you typically buy these in new or used condition?

| New | Used | Comments | Response Rate |
|-----|------|----------|---------------|
| 41 | 48 | 16 | 92% |

2018 Feasibility Assessment for Drayage Trucks –
Section 13: Appendix C: Truck Operator Survey Questions and Summary of Responses

| Question | Survey Results |
|----------|----------------|
|----------|----------------|

11 If you own some or all of your trucks, what is the average purchase price that you pay for those trucks?

| New Truck Purchase Price: | | Used Truck Purchase Price: | |
|---------------------------|-----------|----------------------------|----------|
| Min | \$80,000 | Min | \$20,000 |
| Max | \$170,000 | Max | \$85,000 |
| Average | \$121,935 | Average | \$47,791 |
| Avg. Wghtd. | \$127,774 | Avg. Wghtd. | \$54,757 |
| Mode | \$125,000 | Mode | \$50,000 |
| StdDev | \$19,685 | StdDev | \$13,790 |
| Total Responses | 40 | Total Responses | 55 |

| Question | Survey Results |
|----------|----------------|
|----------|----------------|

12 Are you considering purchasing trucks with any of the following alternative fuel platforms in the next three years?

| Natural Gas - CNG | Natural Gas - LNG | Battery-electric | Plug-in Hybrid Electric | Hydrogen Fuel Cell | Other | All of the above | None of the above | Please share any additional comments below. | Total Responses | Response Rate |
|-------------------|-------------------|------------------|-------------------------|--------------------|-------|------------------|-------------------|---|-----------------|---------------|
| 13 | 11 | 16 | 9 | 6 | 1 | 10 | 50 | 9 | 91 | 94% |

SAN PEDRO BAY PORTS CLEAN AIR ACTION PLAN

RE: DETERMINATION OF REVISED TECHNOLOGY READINESS LEVEL STATUS FOR NEAR-ZERO EMISSION NATURAL GAS ENGINES IN THE PORTS 2018 TECHNOLOGY FEASIBILITY ASSESSMENT FOR DRAYAGE TRUCKS

The San Pedro Bay Ports Clean Air Action Plan 2017 Update (CAAP) established the need to prepare feasibility assessments to evaluate the status of technology and supporting infrastructure that will be required to achieve the various CAAP strategies. The 2018 Feasibility Assessment for Drayage Trucks (Assessment) was intended to evaluate the current state of zero-emission (ZE) and near-zero-emission (NZE) fuel-technology platforms suitable for drayage trucks – including infrastructure readiness to fuel and service them. The Ports agreed to update the Assessment at least every 3 years in order to allow the various technologies an opportunity for development and reassessment. However, we recognize that there may be instances in the interim that warrant an update or determination which amends the Assessment. This Determination Statement assesses the request to update the findings in the Feasibility Assessment using the following *minimum* criteria, which are required for all such requests:

1. The findings must identify specific elements of the Feasibility Assessment to be updated.
2. Supporting data specific to the requested elements must be provided.
3. The data must be corroborated by a credible third party with technical expertise and involvement with generation of the data.

In this particular instance, new and important information on NZE natural gas drayage trucks has emerged. Since the publication of the first Assessment in April of 2019, Clean Energy and Cummins Westport have completed a demonstration of twenty drayage trucks with NZE natural gas engines under a grant (GFO-16-604) provided by the California Energy Commission (CEC) and the South Coast Air Quality Management District (SCAQMD). As part of that demonstration, the project team submitted a final report to the CEC and the SCAQMD documenting the results of the demonstration. Further, Clean Energy has submitted a copy of the report to the Port of Long Beach and Port of Los Angeles and requested that the report constitute evidence that NZE natural gas engines in drayage have achieved the highest Technology Readiness Level (TRL), by moving from TRL 8 to TRL 9. A copy of the report is provided as an appendix to this determination statement.

As discussed in this Determination Statement, the Ports resolve that the TRL of near-zero natural gas engine technologies in drayage operation has reached TRL 9. This alteration of the TRL does **not** change the overall feasibility rating for this technology; other parameters of infrastructure availability, economic workability and operational feasibility still remain to be fully addressed before “fully feasible” can be assessed to near-zero natural gas trucks.



Port of Long Beach | Environmental Planning
415 W. Ocean Blvd. | Long Beach, CA 90802
562.283.7100



Port of Los Angeles | Environmental Management
425 S. Palos Verdes Street | San Pedro, CA 90731
310.732.3675

The San Pedro Bay Ports Clean Air Action Plan was developed with the participation and cooperation of the staff of the US Environmental Protection Agency, California Air Resources Board and the South Coast Air Quality Management District.

Introduction

The 2018 Feasibility Assessment for Drayage Trucks evaluated several drayage truck technologies, including battery-electric, fuel cell, plug-in hybrid, NZE natural gas, and NZE diesel platforms. As part of that evaluation, the Assessment assigned Technology Readiness Levels (TRL) to each technology. The TRL definitions are based on US Department of Energy definitions and are summarized in Table 1.

Table 1. Definitions for Technology Readiness Levels (TRLs) adapted from U.S. DOE

| Relative Stage of Development | Corresponding TRL # | DOE's TRL Definition / Description (condensed / abbreviated) |
|--|---------------------|--|
| Systems Operations | TRL 9 | Actual system in its final form and operated under full range of operating mission conditions . Examples include using the actual system with the full range of wastes in hot operations. |
| Systems Conditioning | TRL 8 | Actual system completed and qualified through test and demonstration . The technology has been proven to work in its final form and under expected conditions. In almost all cases, this TRL represents the end of true system development . |
| | TRL 7 | Full-scale, similar prototype system demonstrated in relevant environment . Represents a major step up from TRL 6, requiring demonstration of an actual system prototype in a relevant environment. |
| Technology Development/ Demonstration | TRL 1-6 | Basic Research through Engineering/pilot-scale demonstrations |

Source: adapted from U.S. DOE, "Technology Readiness Assessment Guide," Table 1: Technology Readiness Levels, September 2011.

NZE natural gas-fueled trucks were determined to be at TRL 8. Specifically, the Assessment found:

“NZE natural gas ICE drayage trucks are currently at **TRL 8** (commercial demonstration and final conditioning). This fuel-technology platform (using CWI’s 12-liter NZE engine) is very likely to move up to **TRL 9**. At least 22 trucks are currently undergoing real-world system conditioning in San Pedro Bay Ports’ drayage service. The general technology is robust and well proven, as evidenced by very strong commercial roll-outs by all of the mainstream heavy-duty truck OEMs.”

Further, the Assessment acknowledged that NZE natural gas engines had achieved TRL 9 in other non-drayage applications. Recognizing that prior deployments of 8.9L natural gas engines, which had been



Port of Long Beach | Environmental Planning
415 W. Ocean Blvd. | Long Beach, CA 90802
562.283.7100



Port of Los Angeles | Environmental Management
425 S. Palos Verdes Street | San Pedro, CA 90731
310.732.3675

The San Pedro Bay Ports Clean Air Action Plan was developed with the participation and cooperation of the staff of the US Environmental Protection Agency, California Air Resources Board and the South Coast Air Quality Management District.

successful in other heavy-duty applications like refuse and transit, into drayage in the 2008-2010 timeframe resulted in mixed success, the Assessment took the conservative stance that 12L NZE natural gas engines should successfully complete demonstrations in a full range of drayage services before being assigned a TRL9 rating.

Clean Energy has submitted a copy of a report documenting demonstration of twenty ISX12N NZE natural gas engines under a grant (GFO-16-604) provided by the CEC and the SCAQMD, requesting that the report constitute evidence that NZE natural gas engines in drayage have achieved TRL 9.

Summary of Demonstration Project

The demonstration program deployed a total of 20 NZE 12L natural gas trucks; three using liquefied natural gas (LNG) fuel systems and 17 using compressed natural gas (CNG) fuel systems. All trucks were designed for the 80,000 lbs gross combined weight rating typical in drayage.

With the exception of one fleet participating in the project, all of the participating fleets serve the ports and operated the trucks on routes between the ports and other destinations in Southern California.

Results of Demonstration Program

According to the project report, 567,603 miles were accumulated during the demonstration; an average of 28,400 miles per truck. A total of 750,000 miles accumulated through mid-August 2019 (two months beyond the June 30 end date of the demonstration period), averaging 37,500 miles per truck.

The reported availability of the natural gas engines was 98%. Engine repairs were reported to be generally minor, including:

- Updates to engine calibrations
- Replacing a crankcase breather motor
- Repair of valve stem seals
- Replacing a spark plug coil

Additionally, repairs and maintenance were required to be conducted on the truck chassis. While these repairs were not documented in the demonstration report, the focus of this TRL assessment and determination statement is the technical readiness of the near-zero natural gas engine, not the truck chassis.

The demonstration report also provided results of driver and fleet owner surveys comparing the NZE natural gas platform to existing diesel trucks. In general, both drivers and fleet owners rated the natural gas platform favorably. While not explicitly discussed in the demonstration report, drivers indicated that the trucks faced performance challenges on routes into the Central Valley and the High Desert, which may



Port of Long Beach | Environmental Planning
415 W. Ocean Blvd. | Long Beach, CA 90802
562.283.7100



Port of Los Angeles | Environmental Management
425 S. Palos Verdes Street | San Pedro, CA 90731
310.732.3675

The San Pedro Bay Ports Clean Air Action Plan was developed with the participation and cooperation of the staff of the US Environmental Protection Agency, California Air Resources Board and the South Coast Air Quality Management District.

be linked to the hauling of heavy loads over the steep grades on the 5 and 15 freeways; an issue addressed in the Feasibility Assessment.

Corroboration of Findings

In addition to reviewing the demonstration report, Ports' staff met with SCAQMD staff in the Technology Advancement Office who are responsible for managing the demonstration program contracts in order to ascertain SCAQMD's perspective on the technology and results of the demonstration. It is SCAQMD staff's opinion that the ISX12N is a fully commercial product in use in drayage and should be considered TRL 9, consistent with the results of the demonstration program and report findings.

Commercial Deployments

At the time of writing of the demonstration report, Cummins and Clean Energy indicated that near-term orders for approximately 140 ISX12N-equipped trucks had been placed or were expected to be placed, with at least 70 units to be delivered in 2019. Specifics of the projected orders were not provided in the report; however, the Ports are aware of at least 100 NZE natural gas trucks currently operating in the Ports drayage fleets – indicating that commercial deployments of the technology have continued beyond the scope of the demonstration program.

Conclusions

The Ports find the following with respect to near-zero natural gas engine technologies:

- The demonstration of twenty ISX12N-equipped drayage trucks has been documented in the referenced report to SCAQMD and the California Energy Commission under GFO-16-604, attached as an appendix.
- The demonstration included the operation of ISX 12N-equipped drayage trucks in typical drayage operations.
- The majority of users in the demonstration program found the performance of the 12N platform to be satisfactory and capable of conducting drayage operations.
- Findings in the demonstration report were supported by a technically credible third party, SCAQMD staff in this case.
- Additional ISX12N-equipped drayage trucks have since been deployed by commercial drayage fleets following the conclusion of the demonstration program, indicating commercial acceptance of the technology in some portion of drayage operations.

Determination Statement

Based on the above findings, the Ports determine that the Technology Readiness Level of NZE natural gas engine technologies in drayage operation has **reached TRL 9**.



Port of Long Beach | Environmental Planning
415 W. Ocean Blvd. | Long Beach, CA 90802
562.283.7100



Port of Los Angeles | Environmental Management
425 S. Palos Verdes Street | San Pedro, CA 90731
310.732.3675

The San Pedro Bay Ports Clean Air Action Plan was developed with the participation and cooperation of the staff of the US Environmental Protection Agency, California Air Resources Board and the South Coast Air Quality Management District.

2018 Feasibility Assessment for Drayage Trucks –
Section 14: Addendum A: Technology Readiness Level Status Update for NZE NG Engines
Appendix: Cummins-Westport ISX12N Engine Demonstration Report

Near-Zero ISX12N Engines in Port Drayage and Regional Trucking



Alternative and Renewable Fuel and Vehicle
Technology – GFO - 16 – 604

Sustainable Freight Transportation Projects

Final Report
Contract No. 18122
October 18, 2019

TABLE OF CONTENTS

| | |
|--|----|
| EXECUTIVE SUMMARY | 4 |
| PROJECT BACKGROUND AND OBJECTIVES | 7 |
| SCOPE OF WORK AND PROJECT TASKS | 9 |
| PROJECT PARTICIPANTS | 10 |
| PROJECT EXECUTION | 13 |
| RESULTS | 17 |
| PROJECT COSTS | 33 |
| CONCLUSIONS & RECOMMENDATIONS | 36 |
| APPENDICES | |
| 1. Project Photos | |
| 2. Truck Route Maps | |
| 3. Fleet & Driver Orientation and Training Handout | |
| 4. Final Project Dashboard Reports | |
| 5. Driver Survey #1 Instrument | |
| 6. Driver Survey #2 Instrument (English & Spanish) | |
| 7. Fleet Survey Instrument | |
| 8. Near Zero Demo Project Update Presentation 10-23-18 | |
| 9. CWI Technical Product Update for ISX12N | |
| 10. Project Cost Detail | |
| 11. Media | |

Acknowledgement

This project was funded by California Energy Commission and South Coast Air Quality Management District.



Executive Summary

Statement of the Project

Heavy-duty diesel trucks in goods movement are responsible for a large portion of smog-forming NOx and toxic diesel emissions in the South Coast Air Basin. Annual emissions inventories compiled by the Ports of Los Angeles and Long Beach rank drayage trucks as the second largest source of NOx and the largest source of greenhouse gas emissions from port-related activities. Port drayage trucks impact disadvantaged communities adjacent to the Ports of Los Angeles and Long Beach, along truck transportation corridors and in truck destination areas such as the Inland Empire.

Replacing diesel trucks with ultralow-NOx (ULN) natural gas trucks is a key strategy of the State Implementation Plan (SIP) and the South Coast Air Quality Management District (AQMD) Air Quality Management Plan (AQMP) and offers an immediate opportunity to reduce toxic diesel, NOx and greenhouse gas emissions caused by diesel trucks along goods movement corridors. There are currently almost 8,000 diesel port drayage trucks that will be banned from port service by the California Air Resources Board (CARB) Truck and Bus Regulation at the end of 2022. Replacing these old trucks with ULN trucks is one of the biggest opportunities for air quality improvement in Southern California.

One of the biggest barriers to adoption of the ISX12N engine among drayage fleets is the lack of experience with the engine operating in the port drayage application. Skepticism about the technology is amplified by the unsatisfactory experience of some truckers with the first-generation natural gas technologies that were deployed in port drayage over 10 years ago in response to the Ports' first Clean Air Action Plan (CAAP) Clean Truck Program. The ISX12N engine needs to be demonstrated to satisfactorily perform in port drayage to build confidence of trucking companies to deploy the technology.

Project Objective

Clean Energy and Cummins Westport (CWI) performed this project to demonstrate 20 trucks repowered with pre-commercial (“beta”) versions of the ISX12N engine for one-year periods. Beta engines were used to allow the project to be performed in parallel with CWI efforts to finalize ISX12N engine development and secure CARB certification to the lowest optional low NOx standard of 0.02 g/bhp-hr. The project goal was to demonstrate the ISX12N engine in a wide variety of port drayage and regional trucking applications



CR&R Performing Regional Hauls

to shorten the traditional time between the initial commercial launch of a new engine and the market prove-out of the new engine.

Project Description

The project acquired 20 used LNG trucks with the predecessor CWI ISX12-G natural gas engine. The LNG fuel systems were replaced with new CNG fuel systems from Agility Fuel Solutions on 17 of the trucks and the other three trucks remained LNG. Other maintenance and repair work prepared the used trucks for port service. The trucks were repowered with beta (pre-commercial) versions of the CWI ISX12N ULN engine.

Seven participating fleets ran the trucks for 12-month demonstration periods and reported monthly on their performance. The truck fleets were CR&R, 4Gen Systems, Green Fleet Systems, NFI, Orange Avenue Express, Pacific 9 Transportation and TTSL.

The demonstration operating phase ran from September 2017 through June 30, 2019 during which the trucks traveled a total of 567,603 miles. The trucks continued running after the conclusion of the project and as of mid-August 2019, had traveled an additional 184,827 miles for a total of over 750,000 miles.

Engine reliability for the project was determined to be 98%. The trucks traveled along all routes and to all destinations that are common to port and regional trucks: near-port areas of Wilmington, Carson and Long Beach; the 710 Freeway corridor to warehouses and the Commerce rail yards; the Inland Empire areas such as Fontana, Riverside and Moreno Valley; San Diego; and the Central Valley.

Drivers were surveyed twice during the project and some drivers provided video interview testimonials. The testimonials can be viewed at this link: www.cleanenergyfuels.com/blog/truck-drivers-like-rng-trucks.

The driver exit survey validated the drivers' positive experience and confidence in the ISX12N and provided the following outcomes.

- 86% of the drivers are likely to recommend a CNG truck to other drivers.
- 96% surveyed gave the engine a rating of adequate or higher when pulling loads.
- 75% of the drivers felt that the trucks were easy to fuel.
- 82% of drivers said that the quietness of the engine was a differentiating factor from previous experiences driving diesel trucks.

Fleets were surveyed at the conclusion of the project. The most significant result is that six of the participating fleets have either acquired, or are planning to acquire, production versions of the ISX12N engine. These near-term orders involve approximately 140 trucks with over 70 to be delivered in 2019.

While outside the scope of this project, all 20 trucks are having the beta engines upgraded

to the certified commercial configuration of the ISX12N. The participating fleets will continue running the trucks with commercial ISX12N engines.

Operating the trucks displaced 129,674 gallons of diesel fuel over the course of the demonstration.

The demonstration reduced 4.02 tons of NOx. Because the trucks were powered by 100% RNG, GHG emissions were reduced by 887 tons. This project removed the equivalent of 171 passenger vehicles off the road.

| | | |
|---|--|---|
|  |  |  |
| 171 Passenger vehicles taken off the road | 13,282 tree seedlings grown for 10 years | 281 tons of waste recycled instead of sent to landfills |

Greenhouse Gas Reduction Equivalencies

Conclusions and Recommendations

The ISX12N has proven to reliably perform port drayage and regional hauling services throughout southern California and beyond. Drivers and fleet operators found the ISX12N to be suitable for the job. Six of the operators have either acquired, or are planning to acquire, trucks with the commercial ISX12N. These near-term orders involve approximately 140 trucks with over 70 to be delivered in 2019.

Deployments of the commercial ISX12N will have an even better experience than this demonstration project by benefitting from new trucks compared to the used trucks in this project.

Orientation and training are critically important for drivers and fleet operators to understand the differences with diesel trucks in terms of driving and maintenance practices. Operators that follow recommended driving and maintenance practices will enjoy a good experience with the ISX12N.

Truckers interested in purchasing a truck with the ISX12N engine will benefit from testing the truck in their specific operation. A program should be launched that makes a demo truck with the ISX12N engine available at each of the area truck dealers. The demo trucks would be provided at no charge to interested truckers.

This project evaluated the ISX12N under normal hauling conditions with truck weights up to the standard legal limit of 80,000 GVW. Future efforts could evaluate the ISX12N, with properly configured truck, for loads up to 95,000 pounds on the overweight corridors in the port complex.

Project Background and Objectives

Problem Statement

CWI developed the ISX12N engine with funding support from AQMD, CEC, and others to be certified to the CARB optional low NOx standard of 0.02 g/bhp-hr. This certification is 90% cleaner than the current new truck engine manufacturing standard, and over 98% cleaner than the emissions standard for port trucks. When fueled with RNG, climate pollutants can be reduced by 50% to over 500% compared to diesel depending on the carbon intensity of the RNG source under the CARB Low Carbon Fuel Standard program. The ISX12N also eliminates 100% of the toxic diesel particulate matter and diesel petroleum use of a diesel truck.

The ISX12N represents an unparalleled opportunity at the Ports of Los Angeles and Long Beach to provide immediate benefits of reducing local air pollution, reducing climate pollutants, and keeping the Ports economically competitive. However, there are barriers to adoption of new engines in the trucking marketplace. These barriers include product unfamiliarity, performance and reliability questions, service and support questions, cost questions, driver acceptance, fueling, and cautious views of non-diesel technologies. Trucking consists of many specific unique markets and applications. While a product can be well proven for a market in general, trucking companies want the reassurance that the product is proven in their vocation and ideally proven in their specific operation. As is typical with new technologies, there needs to be innovation leaders that first try the new technology and demonstrate the acceptability on behalf of the many others in the market.

There is also a time lag between when a new product is introduced and when that product is proven to be acceptable and can begin to penetrate the market. The normal sequential process loses valuable time in terms of vital emissions reductions that need to occur over the next few years to improve air quality and help meet federal air quality attainment requirements.

In summary, the ISX12N represents a transformational opportunity to reduce air and climate pollution while keeping the Ports functioning and competitive. The challenge that loomed was overcoming as quickly as possible the barriers to adoption.

Project Proposal

AQMD, CEC, Clean Energy and CWI developed a strategy while the ISX12N engine was under development to introduce the engine in port drayage and regional trucking before commercial availability. This strategy sought to perform market demonstration so that market acceptance could be ready upon availability of the commercial product. The strategy leveraged the standard engine development process used by CWI in preparing

new engines for commercial launch. CWI performs field testing of engines with selected customers prior to commercial availability. The field testing is done in phases, typically the first phase is an “alpha” engine trial and a second phase is a “beta” engine trial. The field testing is done throughout the US in many geographic regions, weather conditions, and trucking vocations to ensure a robust product that is tested in as many conditions as possible.

The ISX12N development benefitted from CWI’s experience with their predecessor 12-liter natural gas engine (ISX12G) that was launched in 2013 and their experience with the smaller 9-liter engine (ISLG) originally launched in 2007. Despite this solid foundation, CWI still performed the comprehensive field test program. In fact, two alpha engines were tested in the Ports by TTSI starting back in 2017 in addition to alpha engine testing by large fleets throughout the US.

Beta engine testing was also done across the US by large fleets. The beta engine program created the opportunity to perform this project. The project plan was developed to use the beta engine for drayage and regional trucking demonstration.

The proposed project was to acquire 20 used natural gas trucks running the predecessor 12-liter natural gas engine, repower these trucks with the beta engine, and provide the trucks to truck fleets to operate. New trucks would have been more ideal for this type of project but used trucks were deployed because of the lower cost. The project tasks included:

1. Acquire 20 used natural gas trucks.
2. Upgrade the used trucks as needed for the project.
3. Repower the trucks with beta (pre-commercial) versions of the ISX12N engine.
4. Select the fleets to operate the trucks for 12-month demonstration periods.
5. Provide truck deployment orientation and training to the participating fleets.
6. Provide ongoing service and support to the participating fleets.
7. Track operating and maintenance parameters, conduct surveys, and collect feedback through the duration of the demonstration.
8. Perform project administration and reporting.

Project Participants



Clean Energy Clean Energy served as contract prime contractor, managed the project, acquired the used trucks, secured fleet participants, and performed project management, administration, monitoring and reporting. Clean Energy also provided the RNG fuel used by the trucks.

www.cleanenergyfuels.com



Cummins Westport, Inc. (CWI) is the leading developer of spark-ignited automotive natural gas engines for commercial transportation applications, such as trucks and buses. CWI provided the beta ISX12N engines, performed the repowers, performed monitoring and reporting, and provided service and support to the operating fleets.

www.cumminswestport.com



Agility Fuel Systems, LLC (Agility) is a leading global provider of clean fuel solutions for medium- and heavy-duty commercial vehicles. Agility installed the ProCab™ 120 CNG system on 17 of the demonstration trucks. It also provided maintenance on this fuel system throughout the project.

www.agilityfuelsolutions.com

Seven trucking companies participated in the demonstration project. Six of the companies deployed the trucks in port drayage and the seventh used the truck in regional hauling.



Total Transportation Services, Inc. (TTSI) is a port drayage company based in Rancho Dominguez, CA, that provides asset-based logistics to distribute imports within the United States and Canada. TTSI operated 3 LNG and 1 CNG demonstration trucks.

www.ttsi.com



Pacific 9 (Pac 9) is an asset-based transportation company headquartered in San Pedro, CA and operates drayage trucks in the Ports of Los Angeles and Long Beach to distribution centers in the Greater Los Angeles region. Pac 9 operated 4 CNG demonstration trucks.

www.pac9.com



4 Gen Logistics (4Gen) is a port drayage company headquartered in Rialto, CA and services the Inland Empire region. 4 Gen initially operated 4 CNG demonstration trucks but reduced this number to 3 due to the driver shortage.

www.4genlogistics.com



CR&R Incorporated (CRR) operates waste and recycling haulers throughout Orange, Los Angeles, San Bernardino, Imperial, and Riverside counties. They service three million people and over 25,000 businesses. CR&R operated one CNG demonstration truck.

www.crrwasteservices.com



NFI Industries (NFI) is headquartered in Camden, NJ and offers distribution, transportation, and global logistics solutions to almost every industry, from retail to aerospace defense. They operate drayage trucks from the Ports of Los Angeles and Long Beach to downtown Los Angeles, the San Fernando Valley, and the Inland Empire. NFI operated 4 CNG demonstration trucks.

www.nfiindustries.com



Green Fleet Systems Green Fleet Systems (Green Fleet) is an established transportation company serving the various business sectors that use the Ports of Long Beach and Los Angeles to ship and receive containerized cargo. They operate drayage trucks to transport goods to various rail and distribution centers throughout Southern California. Green Fleet operated the one CNG demonstration truck that came from 4 Gen Logistics.

www.greenfleetsystems.com



Orange Avenue specializes in heavy haul port drayage applications, particularly with agricultural exports from the Central Valley Region. Orange Avenue operated 3 CNG demonstration trucks.

www.3riverstrucking.com

Project Execution

The project was managed by Clean Energy and CWI. The project team conducted weekly and even more frequent communications with the project participants, weekly project telephone conference calls, and monthly data collection and reporting.

The project was executed in two phases. Phase 1 was an early start phase approved by AQMD to deploy 3 trucks prior to contract. Phase 2 deployed the remaining 17 trucks.

Clean Energy acquired three 2015 Freightliner Cascadia trucks with LNG fuel systems for Phase 1. Clean Energy acquired 17 2014 Peterbilt 384 trucks for Phase 2. The mix of trucks reflects the used natural gas trucks that were available in the marketplace at the time of acquisition that met the budget constraints of the project. The Peterbilt trucks came with LNG fuel systems at the time of acquisition. However, the decision was made to replace the LNG fuel systems with CNG fuel systems because the LNG systems were in disrepair. Switching to CNG also presented the opportunity to introduce CNG to the port market. Agility built and installed the CNG fuel systems. New rear axles were installed in the Peterbilt trucks to match the port drayage duty cycle. Repairs were performed on the Peterbilt trucks for tires, suspensions, batteries, and various other used truck issues to prepare them for the project.

The transmissions in the used trucks are worthy of comment. The three Freightliner trucks had automatic transmissions. The seventeen Peterbilt trucks had manual transmissions. Driver preference for transmission type is highly personal. Drivers that like manual transmissions do not like automatics, and vice versa. Manual transmissions had slightly higher preference with drivers in the driver survey than automatics, despite the benefits of automatics. Automatics offer more flexibility in recruiting new drivers since training is simplified compared to manual transmissions. Automatic transmissions also have the advantage of a 2x torque multiplier in first and second gears, helping a truck accelerate from stop.

CWI built the 20 beta engines and performed the truck repowers at the four Cummins service centers in southern California. This strategy was followed so that trucks could be repowered in parallel at four locations, shortening the overall repower time compared to doing all 20 repowers at a single location. The four service centers are in Downey, Bloomington, Ventura and El Cajon

CWI also installed GPS tracking devices



in the trucks. The deployed trucks were configured for hauling up to legal limit of 80,000 pounds GVW.

Project decals were designed and installed on the demonstration trucks.

Clean Energy sought and secured the seven participating fleets in consultation with AQMD and CWI. The seven fleets are representative of port drayage and regional hauling operations with a wide diversity of operating approaches. Each fleet signed a participation agreement. Onboarding was performed by Clean Energy and CWI. Clean Energy, CWI and Agility also provided one or more training and orientation sessions with each fleet.

These sessions covered:

- Project description, requirements & administration



NFI Orientation

- Orientation for the truck, engine and fuel system
- Driving instructions
- Maintenance, service and support instructions
- Fueling training

The project operating requirement was for each truck to run for 12 months under the demonstration project. Most trucks actually ran for more than 12 months during the



Orange Avenue Express Orientation

operational phase of the project. The operating period for each participating fleet is summarized below. Note that Green Fleet assumed the operation of one of the trucks originally deployed by 4Gen Logistics so that this truck operated for 12 months spread over the two fleets.

Participating Fleet Operation

| Fleet | # of Trucks | Start Date | Final Month |
|--|-------------|------------|-------------|
| Premium Transportation Services (TTSI) | 3 LNG | 9/25/2017 | 2/2019 |
| Premium Transportation Services (TTSI) | 1 CNG | 7/13/18 | 6/2019 |
| Pacific 9 Transportation, Inc. | 4 CNG | 2/15/2018 | 5/2019 |
| 4 Gen Logistics, LLC (Duncan & Son) | 3 CNG | 4/25/2018 | 6/2019 |
| CR&R | 1 CNG | 5/11/2018 | 6/2019 |
| Orange Avenue Express (Three Rivers) | 3 CNG | 5/8/2018 | 6/2019 |
| NFI Interactive Logistics, LLC | 4 CNG | 5/25/2018 | 6/2019 |
| Green Fleet Systems, LLC (from 4Gen) | 1 CNG | 11/5/2018 | 6/2019 |
| | | | |

Results

Routes Traveled by Demonstration Trucks

The demonstration trucks operated successfully throughout all southern California along the routes and to the destinations typical for drayage and regional hauls. The engines were tested on some of the toughest routes, according to the driver surveys, taken by drayage trucks in the South Coast Basin. These routes include State Route 60 east through Metropolitan Los Angeles to the Inland Empire, the five mile stretch, 6% grade, 1600 foot ascent along Interstate 5 known to truck operators as the Grapevine, Bridge 47 located just outside of The Port, as well as local routes up Interstate 710 and 605 leading out of The Port. Trucks specifically traveled to and from the Ports to:

- Near-port destinations in Wilmington, San Pedro, Long Beach, and Carson
- Along the 710 Freeway to destinations along the way and the railyards in Commerce
- Inland Empire destinations such as Fontana, Riverside, San Bernardino, Moreno Valley, Jurupa Valley, etc.
- San Diego
- San Joaquin Valley

Each participating fleet had routes that were consistent among companies but also unique to that fleet. The trucks were equipped with GPS tracking devices to track routes. Example routes are shown in the following maps. Additional route maps are included in the appendix. Each map is a one-week snapshot of the routes travelled by that fleet's trucks for that week.

4Gen

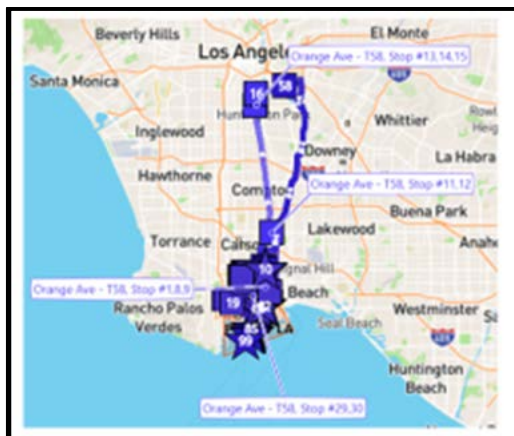

Orange Avenue Express

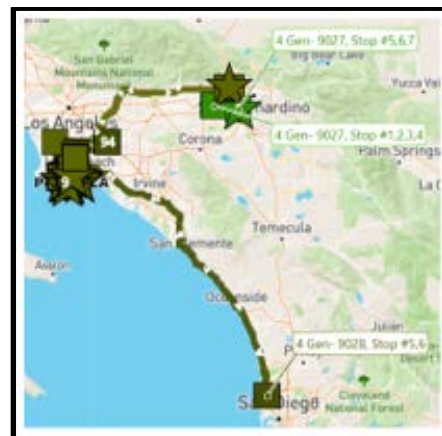

CR&R

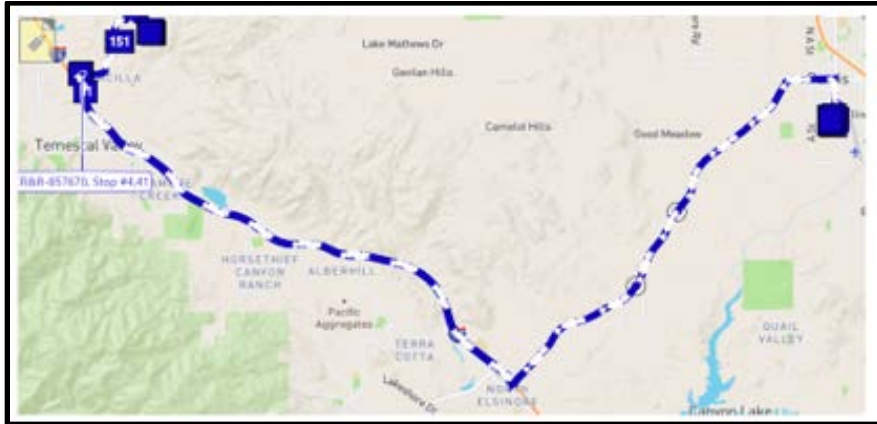

Green Fleet Systems

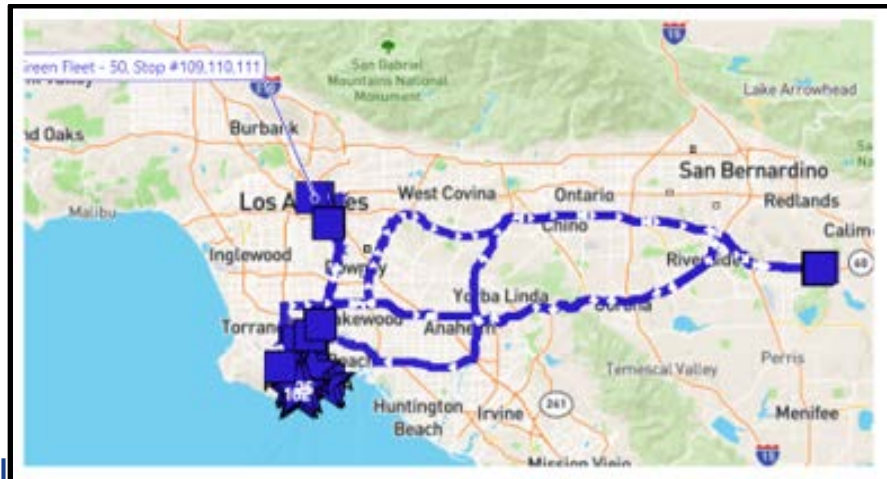

NFI



Pacific 9 Transportation

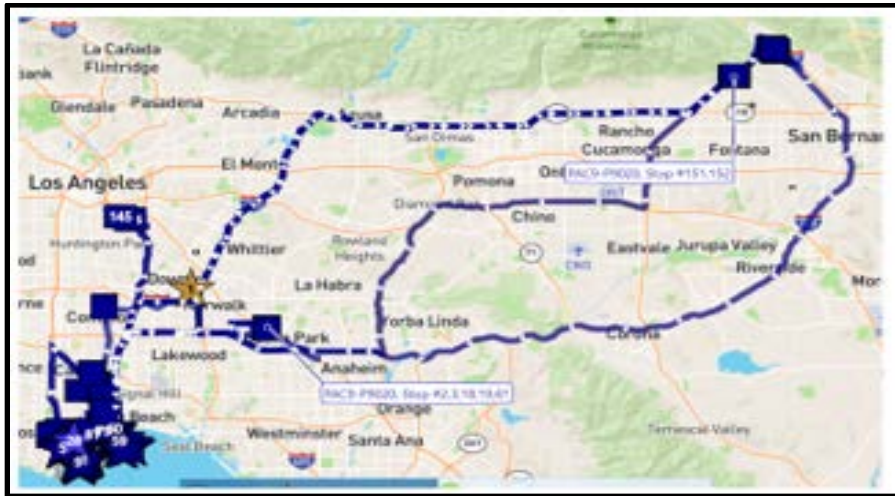

TTSI



Miles Traveled

Demonstration trucks traveled a total of 567,603 miles over the duration of this operational phase of the project. As mentioned, the trucks continued to operate after the conclusion of the project in June. As of mid-August, the trucks ran an additional 184,827 miles for a total of over 750,000 miles. Accumulated miles are shown in the chart below.

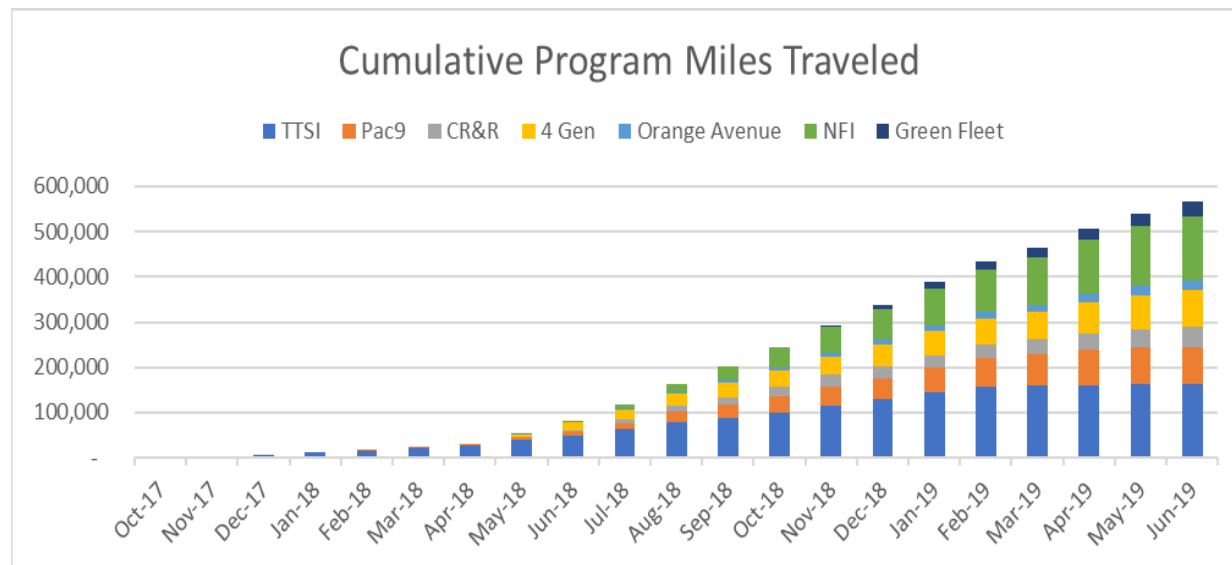

Engine Results

The beta ISX12N engines performed exceptionally well for this project. Engine availability was 98%. Engine downtime was experienced in three categories:

1. Routine maintenance such as oil changes and other prescribed maintenance services.
2. Repair of engine issues. Engine repairs were infrequent over the 20 engines. Engine repairs included:

- a. Update engine calibrations. It is noted that since these are Beta engines, the calibration updates were more frequent than what is the practice with the commercial version of engines, resulting in higher downtime than with the commercial product.



|Cummins Westport ISX12N Engine

-
- b. Replace a crankcase breather motor.
 - c. Repair valve stem seals.
 - d. Replace spark plug coil.
 3. User error. One truck had the wrong engine oil used in the truck which caused engine damage that was repaired.

The trucks in this project were used trucks. As used trucks, they experienced non-engine issues that are typical for operating and maintaining used trucks. Since the objective of this project was to focus on the beta ISX12N engine, unrelated non-engine used truck issues are noted but were not tracked or analyzed.

Emissions Reduction

Diesel Particulate Matter

Diesel particulate matter (DPM) is classified in California as a Toxic Air Contaminant and a carcinogen. Diesel trucks are a major source of DPM in the South Coast Air Basin, particularly as the emission control system on the trucks become less efficient with age, poor maintenance practices, and equipment failure. The ISX12N natural gas engine emits zero diesel particulate matter (DPM), providing 100% reduction of DPM.

NO_x

NO_x is a smog-forming pollutant that causes and/or contributes to respiratory illnesses such as asthma. According to the American Lung Association, the Los Angeles-Long Beach area has the worst air quality in the US. The South Coast Air Basin is classified as “*extreme non-attainment*” for ground level ozone by the US EPA. The region faces a deadline to meet attainment by 2023 or risk facing federal sanctions such as the loss of \$19B in transportation funding and replacing local control over air quality issues with federal control.

Stoichiometric combustion in combination with cooled-EGR creates the ideal combustion process with the chemically correct mixing of fuel and air, offering increased power density and thermal efficiency. It also reduces in-cylinder combustion temperatures and creates an oxygen-free exhaust, which then enables the use of a TWC for nitrogen oxide (NO_x) control.

NO_x emissions from the ISX12N engine are certified by CARB at the lowest optional low NO_x standard of 0.02 g/bhp-hr. The NO_x reductions from the ISX12N rival the reductions possible by battery electric trucks when power generation in the basin is included in the assessment of emissions. Comparative NO_x emission reductions are listed in the table below. Estimated NO_x emissions reductions from the trucks deployed in this project are shown in the project dashboards in the appendix.

| | 2007 EPA Standard (8,000 Port Trucks) g/bhp-hr | 2010 EPA Standard g/bhp-hr | Actual In-Use Emissions for 2010 EPA Standard Diesel Trucks Measured by UC Riverside |
|--------------------------------|--|-------------------------------|---|
| Diesel Truck | 1.2 | 0.2 | 1.02 |
| ISX12N Natural Gas Truck | 0.02 | 0.02 | 0.02 |
| % Reduction | 98.3% | 90.0% | 98% |
| | | | |

Greenhouse Gases (GHG)

Immediate GHG reductions are needed to stop the planet's temperature rise. Reducing emissions of short-lived climate pollutants such as methane from municipal waste, landfills, agricultural operations and food/green waste is particularly critical and is a State of California priority. Capturing methane emissions from decaying organic matter and using this methane as renewable natural gas (RNG) to replace conventional natural gas is the most impactful way to reduce GHG in transportation. According to CARB, RNG sources can reduce GHG by up to 500% when used as a transportation fuel to replace diesel as shown in the chart below from <https://ww3.arb.ca.gov/fuels/lcfs/fuelpathways/pathwaytable.htm>.

The estimated GHG reductions from the trucks used in this project are shown in the project dashboards in the appendix.

Surveys

Three surveys were conducted for the project listed below. The survey instruments are included in the appendix.

1. Driver Survey 1 – Initial Feedback
2. Driver Survey 2 – Final Feedback
3. Fleet Survey – Final Fleet Feedback

Driver Survey #1 was conducted in September 2018 to gain feedback from drivers on their early impressions of the trucks. This feedback was also helpful for identifying measures to further support and train drivers and other personnel at each company.

Driver Survey #2 and a Fleet Survey were conducted in July 2019 to capture final feedback from drivers and the participating fleets.

Video interviews of drivers were conducted and can be viewed at this link: <https://www.cleanenergyfuels.com/blog/truck-drivers-like-rng-trucks>. The videos capture driver feedback in these key areas:

- Engine Performance
- Comparison to Diesel
- Environmental Stewardship
- Fueling Experience

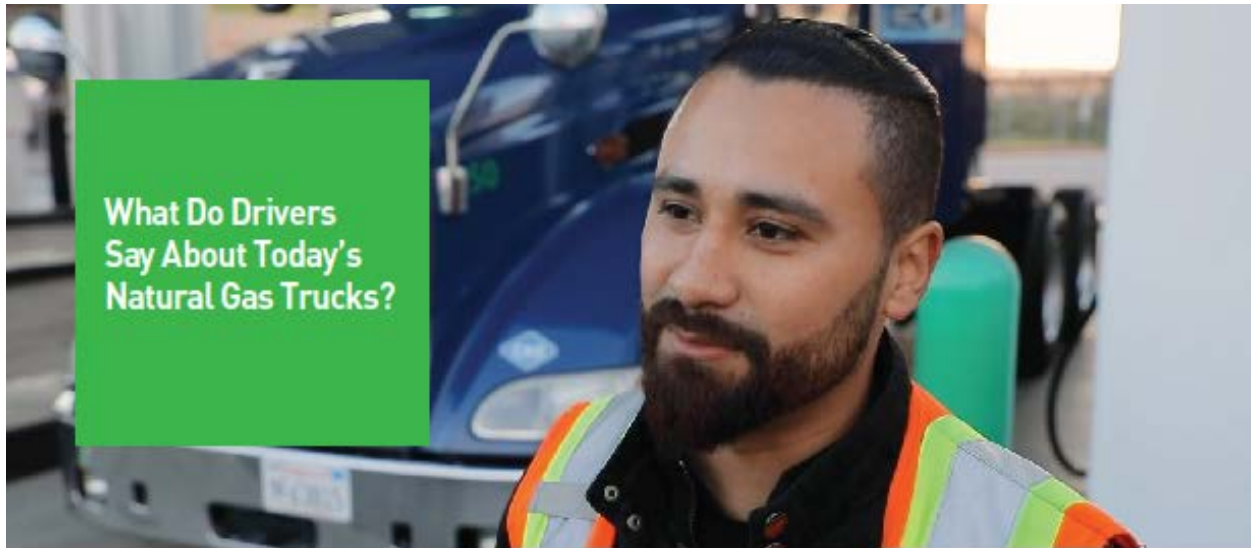

What Do Drivers Say About Today's Natural Gas Trucks?

We captured feedback from drivers in the near-zero RNG truck demonstration project. The technology has come a long way since the first units deployed 10 years ago. Drivers give RNG trucks a big "thumbs up". See what drivers have to say in the videos below. Enjoy!



Truck Drivers Like the Performance of RNG Trucks
Near-zero natural gas trucks are great for the environment, but can they hold up to the demanding business of port trucking? Watch what real port truck drivers have to say about the performance of today's natural gas trucks.



Truck Drivers Prefer RNG Trucks Over Diesel
Can a near-zero natural gas truck powered by RNG really be better than a diesel truck? Watch what real port truck drivers have to say.



Truck Drivers Like Helping the Environment with RNG Trucks
Real port truck drivers share their views on helping the environment by fighting air and climate pollution with near-zero natural gas trucks powered by RNG.



Truck Drivers Like Fueling RNG Trucks
What is it like to fuel a near-zero natural gas truck? Real port truck drivers share their story.



Driver Survey 1

The first survey sought early feedback from drivers in three areas: the truck, the engine, and the fuel. The surveys were designed this way to differentiate driver impressions of the used trucks versus the engine. The surveys also collected the driver's first impressions versus their impression after running the trucks for a period of time. Survey results are shown in the charts below.

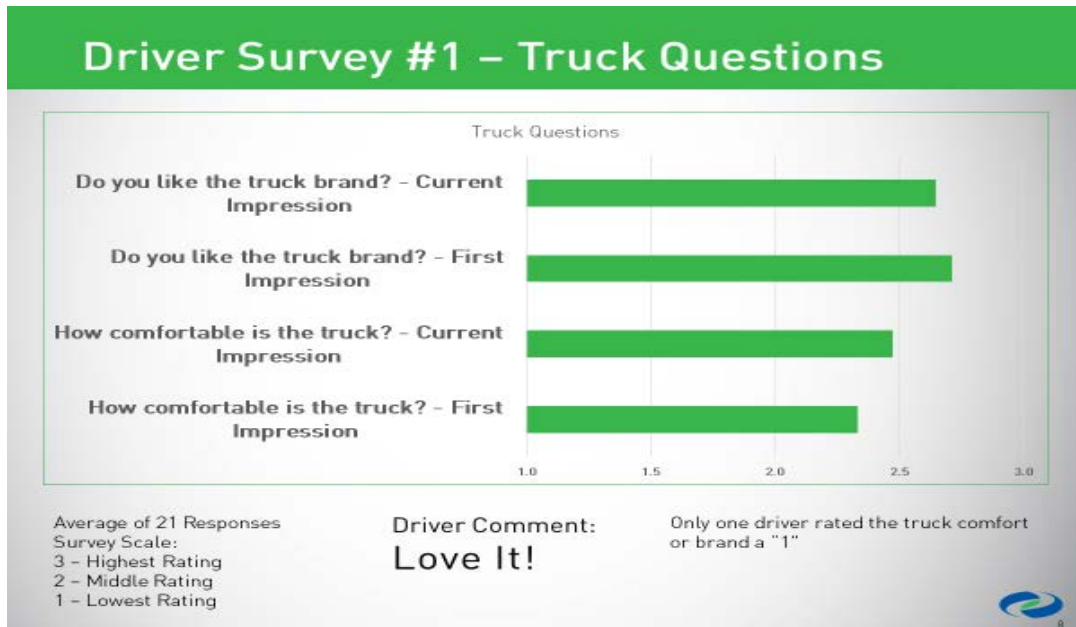

Drivers rated the truck brands and comfort favorably except one driver did not like the truck at all and gave it the lowest rating. One driver volunteered the comment "Love it!".

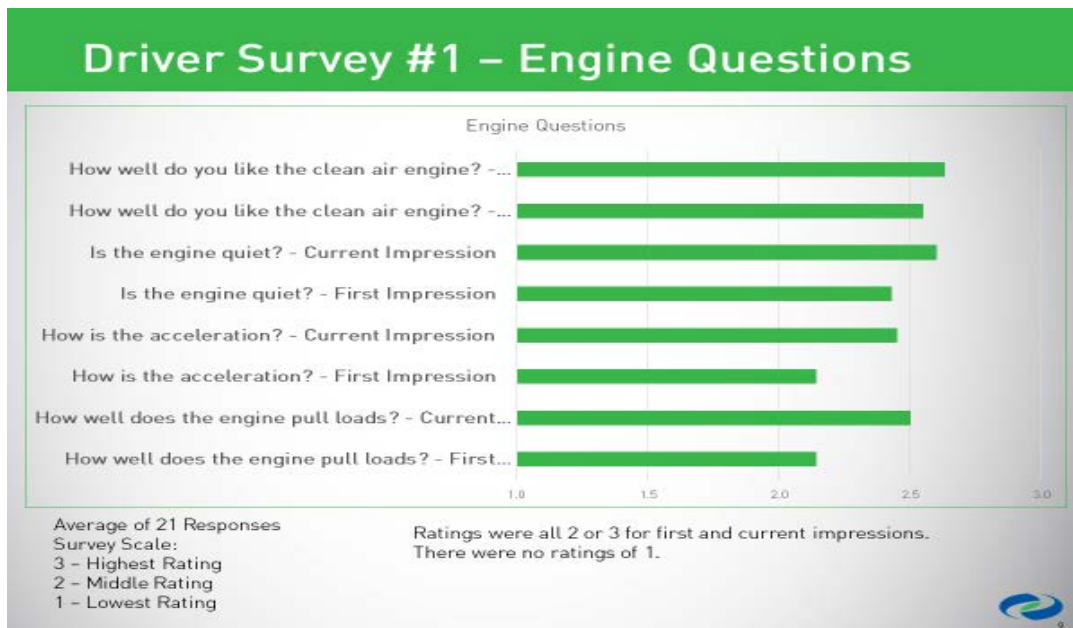

Drivers rated the engine favorably, with ratings increasing on the second impression over the first impression. It is noted the drivers from one company rated the engine poorly on first and second impressions. These negative ratings are attributed to the driver comparison to their baseline trucks which have very large engines for heavy hauling.

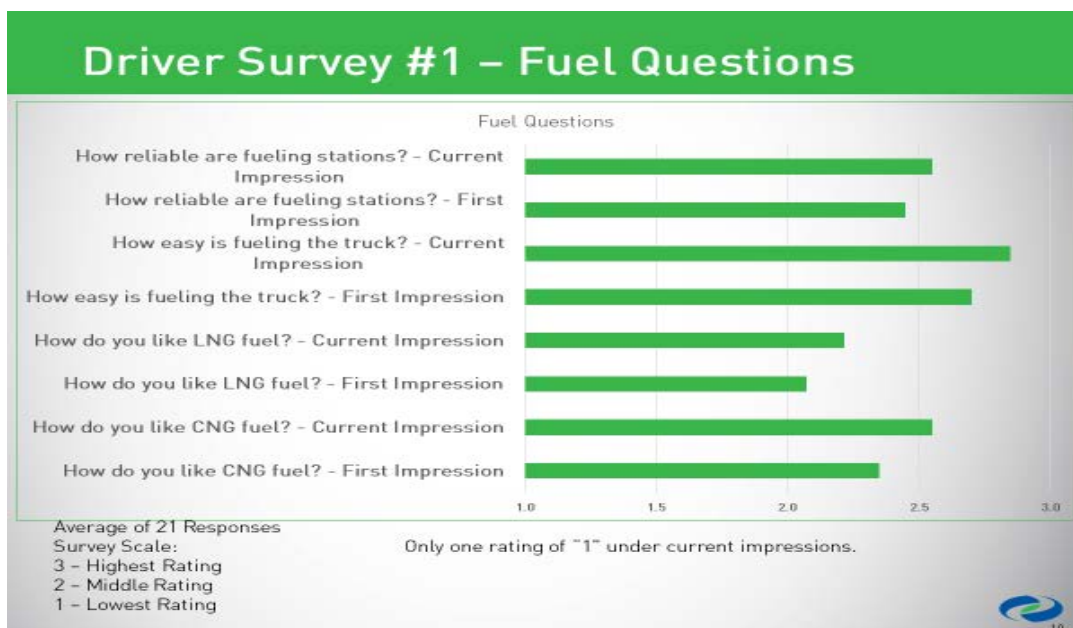

Drivers rated fueling favorably, with CNG fueling rated higher than LNG fueling.

Driver Survey 2

The second driver survey sought final feedback from the drivers. The survey found that 86% of the participating drivers are likely to recommend a natural gas truck to other drivers. Most of the drivers (68%) reported having no prior experience driving a natural gas truck.

When thinking about switching from diesel to alternative fuels, common worries that drivers have revolve around fueling. The survey found that 75% of the drivers felt that trucks were easy to fuel.

Another concern that drivers typically have about natural gas vehicles is the horsepower compared to diesel trucks. In this project, 91% of the drivers reported having experience driving diesel trucks with a horsepower greater than the Cummins ISX12N-G's 400HP engine. Ninety-six percent of the drivers surveyed gave the engine a rating of adequate or higher pulling loads.

Drivers were asked to select what is most important factor with their truck: reliability; comfort; clean emissions; or engine horsepower. Reliability was selected by 56%, comfort by 21%, power by 18%, and clean air by 6%. Although horsepower is often cited in favor of diesel engines over natural gas, horsepower is not the most important aspect for drivers. Furthermore, 82% of drivers said that the quietness of the engine was a differentiating factor from previous experiences driving diesel trucks.

| Survey Question | Responses |
|---|--|
| Drivers Past Truck Experience | |
| What is the truck brand of your usual truck? | All truck brands were noted in responses. |
| What is the engine size (horsepower) of your usual truck? | 400 to 450 HP was the most common response, followed by 450 to 500 HP. One responded with greater than 500 HP. For comparison, the ISX12N engine is 400 HP. |
| Have you operated other alternative fuel trucks before? | Natural Gas – 9 respondents Natural Gas Hybrid – 1 respondent Battery Electric – 2 respondents Hydrogen Fuel Cell – 3 respondents Propane – 1 respondent |

| | |
|--|---|
| Engine Performance | |
| How well do you like the engine? | The average response was 2.3 out of a maximum rating of 3.0. |
| How well does the engine pull loads? | The average response was 2.4 out of a maximum rating of 3.0. |
| How is the acceleration of the engine? | The average response was 2.1 out of a maximum rating of 3.0. |
| How do you like the quietness of the engine? | The average response was 2.4 out of a maximum rating of 3.0. |
| Describe the toughest route you put the truck through? How did the engine perform on this route? | Respondents provided a wide variety of toughest route responses. The average rating of the engine for these toughest routes was 1.9 out of 3.0. |
| Fueling Experience | |
| How easy is fueling the truck? | The average response was 2.6 out of a maximum rating of 3.0. |
| How reliable are fueling stations? | The average response was 2.1 out of a maximum rating of 3.0. |
| Truck Aesthetics / Performance | |
| How reliable is the truck? | The average response was 2.4 out of a maximum rating of 3.0. |
| How comfortable is the truck? | The average response was 2.2 out of a maximum rating of 3.0. |
| Rating for destination(s) your truck traveled during the project: Nearby the port Up the 710 area Inland Empire Central Valley | Near port average rating was 2.7 out of 3.0. The 710 corridor average was 2.7 out of 3.0. Inland Empire average was 2.3 out of 3.0. Central Valley was 1.4 out of 3.0. |

| Conclusions | |
|---|---|
| Did the truck provide confidence that it can get the job done? Yes/No | 24 responded "Yes". 4 responded "No". |
| What is most important to you as you haul from the port when it comes to the truck you are operating? | Reliability – 19 responses Power – 6 responses Comfort – 7 responses Clean Emissions – 2 responses |
| How likely are you to recommend a natural gas truck to other drivers? | 24 indicated "Definitely" or "Likely". 4 indicated "No". |
| | |

Fleet Operator Survey

The participating fleets were surveyed at the conclusion of the project to gain feedback from the fleet/company perspective. The survey collected company fleet and profile information as well as experience with the demonstration trucks. The most significant result is that 6 of the 7 participating fleets have either acquired, or are planning to acquire, production versions of the ISX12N engine. These near-term orders involve approximately 140 trucks with over 70 to be delivered in 2019. Survey results are summarized in this following table.

| Survey Question | Responses |
|--|--|
| Fleet Information | |
| What is the typical truck brand in company's fleet? | All truck brands are represented in the participating fleets including Freightliner, Kenworth, Peterbilt, Volvo, Mack and International. |
| What is the typical engine size (horsepower) in the fleet? | Four companies identified 400 to 450 HP, one company indicated 450 to 500 HP, and one company indicated less than 400 HP. For comparison, the ISX12N engine is 400 HP. |

| | |
|---|--|
| What is the size of the fleet? | Fleet sizes ranged up to 40 trucks for those that responded. |
| Do customers provide incentives to operate trucks that reduce air pollutants and/or climate pollutants? | Two companies responded yes, the other five responded no. |
| Does your company have a sustainability policy? | Two companies responded yes, the others responded no or did not answer. |
| Truck Performance | |
| What was the typical gross vehicle weight of demo truck loads? | 75,000 to 80,000 lbs. - 3 companies 70,000 to 80,000 lbs. - 1 company 70,000 to 75,000 lbs. - 1 company 65,000 to 70,000 lbs. - 2 companies |
| What was the heaviest gross vehicle weight load hauled? | 80,000 lbs. - 4 companies 73,180 lbs. - 1 company No answer - 2 companies |
| What areas did the truck operate? How well did the truck perform for this run? | Near Port – Six responded yes with an average rating of 2.8 out of 3.0 maximum. 710 Freeway – Six responded yes with an average rating of 2.8 out of 3.0 maximum. Inland Empire – Six responded yes with an average rating of 2.4 out of 3.0 maximum. Central Valley – One responded yes with an average rating of 1.0 out of 3.0 maximum. High Desert – One responded yes with an average rating of 2.0 out of 3.0 maximum. |
| Conclusions | |
| What is your rating of the engine performance? | Five responded that the engine performed for all of their routes. Two responded that the engine preformed for most of their routes. |

| | |
|---|---|
| <p>How do the operating costs compare to a similar diesel truck?</p> | <p>Four responded that costs were lower than a diesel truck, Two responded costs were the same, One did not respond.</p> |
| <p>How does engine down time compare to a similar diesel engine?</p> | <p>Two responded down time was less than diesel, Two responded down time was the same, One responded that down time was higher (This was the truck that was damaged from using incorrect engine oil). Two did not respond.</p> |
| <p>Do your drivers prefer the natural gas truck or a diesel truck?</p> | <p>Three responded that their drivers prefer natural gas, Three responded that drivers prefer diesel trucks, One indicated no preference.</p> |
| <p>What are the plans for purchasing additional natural gas trucks?</p> | <p>Six of the seven participating companies have taken delivery or plan to purchase additional natural gas trucks: Four indicated plans to purchase in 2019 with 120 trucks already ordered or delivered. One company indicated “no” but has since purchased additional trucks and submitted grant applications for natural gas trucks. One company did not respond but is in process of using a grant to purchase 7 trucks. One company did not respond and has no known plans to buy additional natural gas trucks.</p> |
| | |

Project Costs

The original project budget and the actual project costs incurred are shown in the tables below. Costs incurred to acquire the used trucks, install the CNG fuel systems, and configure the trucks for drayage were higher than budgeted. Clean Energy paid these extra costs as a contribution to the project.

CWI costs to build the beta engines, repower the used trucks, and provide maintenance and other project services were consistent with the project budget.

Costs incurred to prepare the used trucks for service were higher than expected, especially for the used Peterbilt trucks. The Peterbilt trucks were heavily used by the prior owner and the trucks typically had over 300,000 miles. There were a number of needed repairs prior to use. These repair costs were spread between Clean Energy and fleet participants. Costs were incurred for a wide variety of items such as (not necessarily for every truck but for one or more trucks):

- Air ride suspension leaks
- Worn shocks
- Worn clutches
- Worn tires
- Replacement batteries
- Missing mud flaps, air horns, mirrors, air fairings
- Fan clutches
- Electrical issues (lights, accessories, wiring, etc.)
- Stability control calibrations
- Back of cab access steps
- Towing

In addition to truck acquisition and repair costs, Clean Energy incurred costs for truck registration fees, federal highway taxes, and labor for project management and administration. The labor for project management and administration was accumulated over the 25-month period that the project ran from inception in 2017 through final report in 2019.

Costs allocated to CEC of \$2,845,000 and to AQMD of \$650,000 matched the project budget. Cost share costs incurred by the project contractors and participating fleets were \$2,717,007, which was \$217,007 more than the project budget of \$2,500,000.

Original Project Budget

This table shows the original project budget with cost shares from the contract.

| Task | Task Description | CEC | SCAQMD | Contractor Cost Share | Total |
|-------|------------------------------------|-------------|-----------|-----------------------|-------------|
| 1 | Truck Acquisition | \$950,000 | \$650,000 | \$0 | \$1,600,000 |
| 2 | Vehicle Integration and Validation | \$1,864,000 | \$0 | \$0 | \$1,864,000 |
| 3 | Vehicle Demonstration | \$0 | \$0 | \$2,500,000 | \$2,500,000 |
| 4 | Final Report & 2-Page Synopsis | \$31,000 | \$0 | \$0 | \$31,000 |
| Total | | \$2,845,000 | \$650,000 | \$2,500,000 | \$5,995,000 |

Revised Project Budget

This table shows the revised project budget with adjusted cost sharing between CEC and AQMD. The revision resulted from AQMD authorization to the project team to deploy three of the demonstration trucks in advance of executing the contract.

| Task | Task Description | CEC | SCAQMD | Contractor Cost Share | Total |
|-------|------------------------------------|-------------|-----------|-----------------------|-------------|
| 1 | Truck Acquisition | \$1,216,100 | \$383,900 | \$0 | \$1,600,000 |
| 2 | Vehicle Integration and Validation | \$1,597,900 | \$266,100 | \$0 | \$1,864,000 |
| 3 | Vehicle Demonstration | \$0 | \$0 | \$2,500,000 | \$2,500,000 |
| 4 | Final Report & 2-Page Synopsis | \$31,000 | \$0 | \$0 | \$31,000 |
| Total | | \$2,845,000 | \$650,000 | \$2,500,000 | \$5,995,000 |

Actual Costs

This table shows the costs that were actually incurred in performing the project. Additional project cost detail is provided in the appendix.

| Task | Task Description and Cost | CEC & AQMD Share | Contractor Share | Total Cost | Budget | Variance Higher (Lower) |
|------|----------------------------------|------------------|------------------|-------------|-------------|-------------------------|
| 1 | Truck Acquisition | \$1,600,000 | \$64,260 | \$1,664,260 | \$1,600,000 | \$64,260 |
| 2 | Vehicle Integration & Validation | \$1,864,000 | \$0 | \$1,864,000 | \$1,864,000 | \$0 |
| 3 | Vehicle Demonstration | \$0 | \$2,651,347 | \$2,651,347 | \$2,500,000 | \$151,347 |
| 4 | Final Report | \$31,000 | \$1,400 | \$32,400 | \$31,000 | \$1,400 |
| | Totals | \$3,495,000 | \$2,717,007 | \$6,212,007 | \$5,995,000 | \$217,007 |

Conclusions & Recommendations

The ISX12N has proven to reliably perform port drayage and regional hauling services throughout southern California and even beyond.

Drivers and fleet operators found the ISX12N to be suitable for the job. Six of the operators have either acquired, or are planning to acquire, trucks with the commercial ISX12N. These near-term orders involve approximately 140 trucks with over 70 to be delivered in 2019.

Deployments of the commercial ISX12N will have an even better experience than this demonstration project by benefitting from new trucks compared to the used trucks in this project.

Orientation and training are critically important for drivers and fleet operators to understand the differences with diesel trucks in terms of driving and maintenance practices. Operators that follow recommended driving and maintenance practices will enjoy a good experience with the ISX12N.

Truckers interested in purchasing a truck with the ISX12N engine will benefit from testing the truck in their specific operation. A program should be launched that makes a demo truck with the ISX12N engine available at each of the four area truck dealers. The demo trucks would be provided at no charge to interested truckers.

This project evaluated the ISX12N under normal hauling conditions with truck weights up to the standard legal limit of 80,000 pounds GVW. Future efforts could evaluate the ISX12N, with properly configured truck, for loads up to 95,000 pounds on the overweight corridors in the port complex.



Appendix 1

Project Photos



South Coast Air Quality Management District
Southern California Trucking Demonstration of Near-Zero ISX12-G Engines
Final Report - Contract No. 18122 - Clean Fuels/CEC



ISX12N Near-Zero Demo Final Report – Project Pictures



TTSI Exiting the Cummins Repower Shop



TTSI Running the Beta Engine on the Dyno



2 of the 17 Peterbilt Trucks



Peterbilt Trucks



Beta Engine Ready for Service



Inspection of the 4 Pacific 9 Trucks

ISX12N Near-Zero Demo Final Report – Project Pictures



Pacific 9 Training



Pacific 9 Fuel System Training



Pacific 9 Fuel System Training



Pacific 9 Fueling Training with RNG



Near-Zero Truck & Mixer Fueling with RNG

ISX12N Near-Zero Demo Final Report – Project Pictures



4Gen Training



4Gen Training



Orange Avenue Training



Orange Avenue Training



TTSI Pulling a Load



CR&R Showing Off New Paint

ISX12N Near-Zero Demo Final Report – Project Pictures



CR&R Loaded & Ready



CR&R Training



CR&R Training



Custom Project Fuel Cards



Decal Placement Decisions



Truck Decal

ISX12N Near-Zero Demo Final Report – Project Pictures



Decal Placement



More Decals



NFI Training



NFI Training



4Gen with Decals



4Gen with Decals

ISX12N Near-Zero Demo Final Report – Project Pictures



4Gen Getting a Fill of RNG



Tractor & Car Hauler Fueling with RNG

Appendix 2

Truck Route Maps



4 Gen

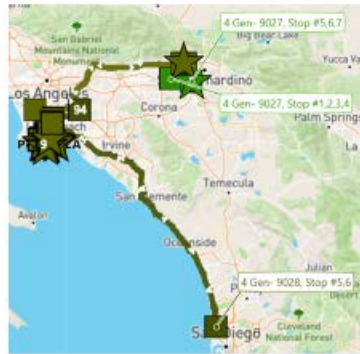

11

4 Gen



11

4 Gen

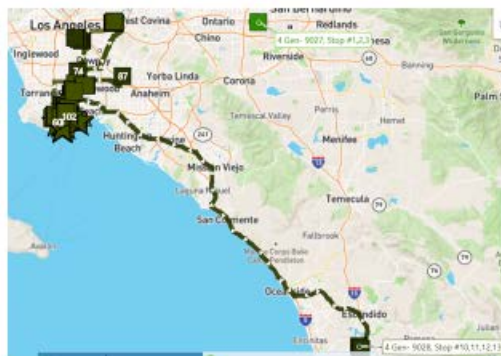

11

4 Gen



11

4 Gen

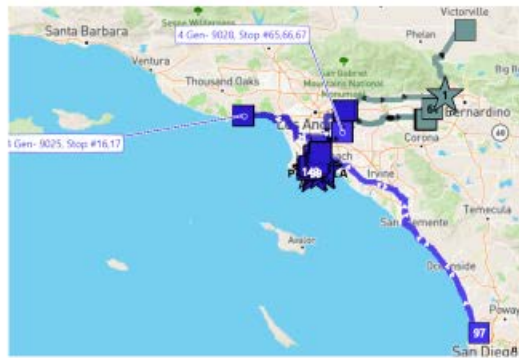

11

4 Gen

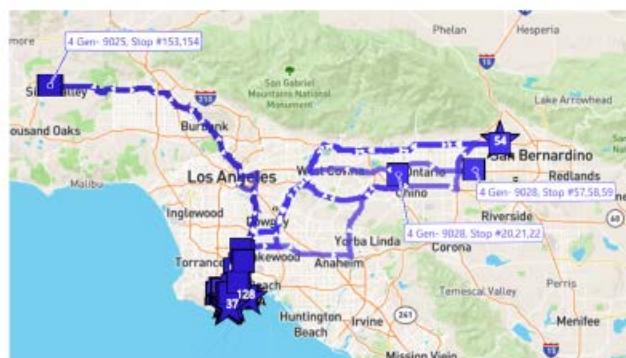

11

CR&R

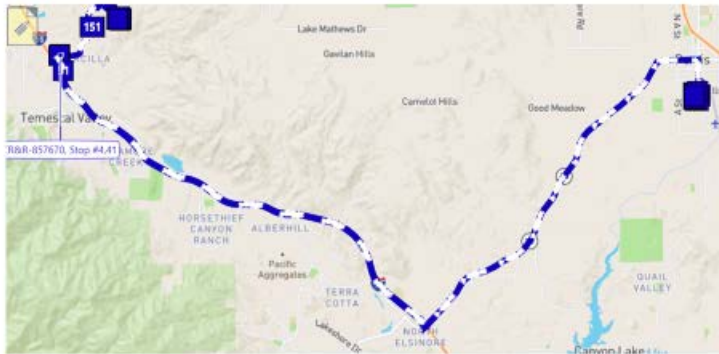

13

CR&R



13

CR&R

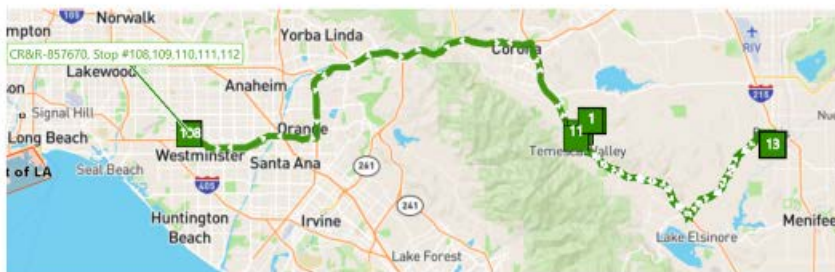

13

Green Fleet

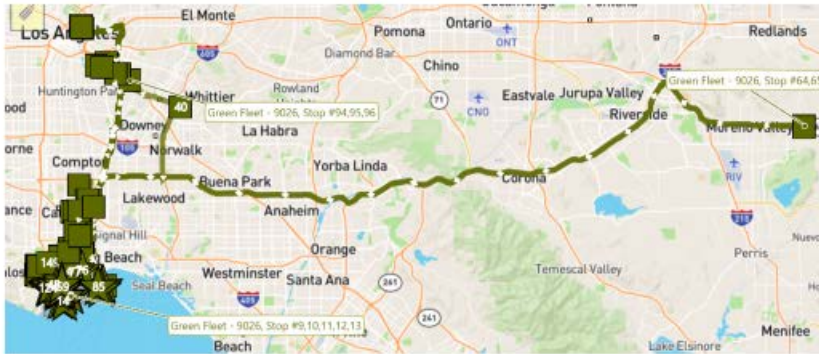

17 3rd email

Green Fleet

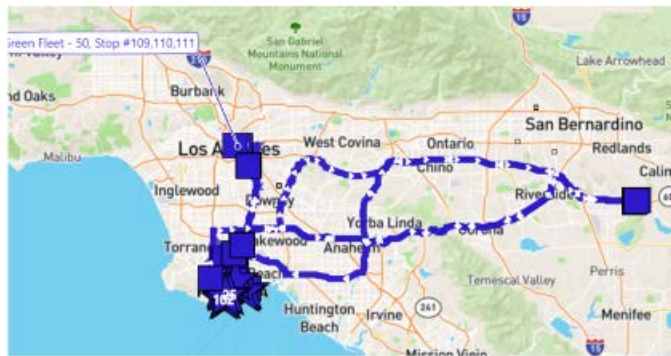

17

Green Fleet

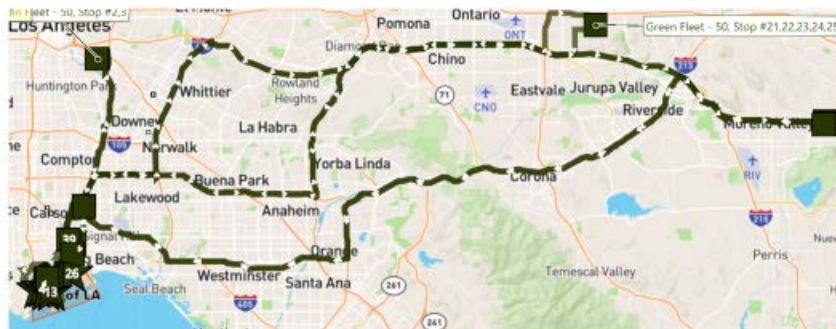

17

NFI



15

NFI



15

NFI



15

NFI

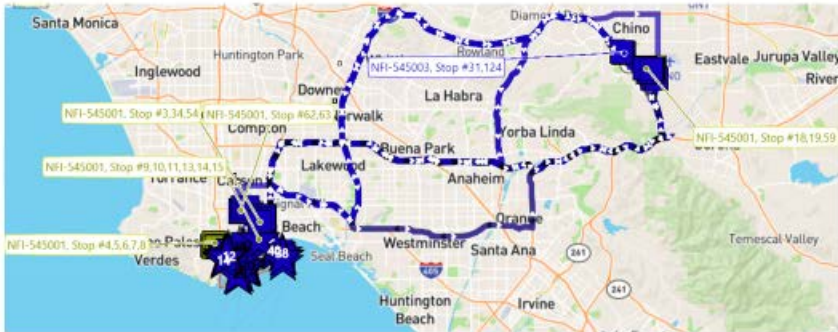

15

NFI



15

NFI



15

Orange Ave



9

Orange Ave

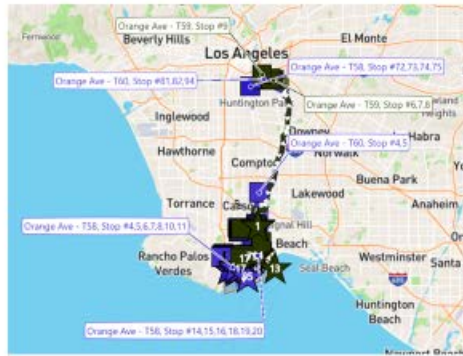

9

Orange Ave

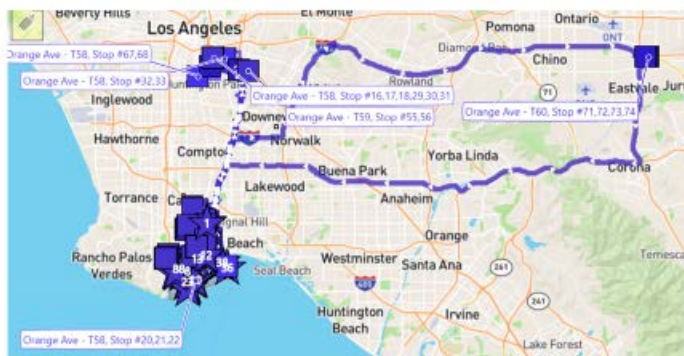

9

Orange Ave

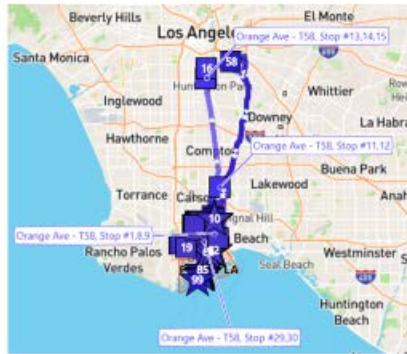

9

Orange Ave

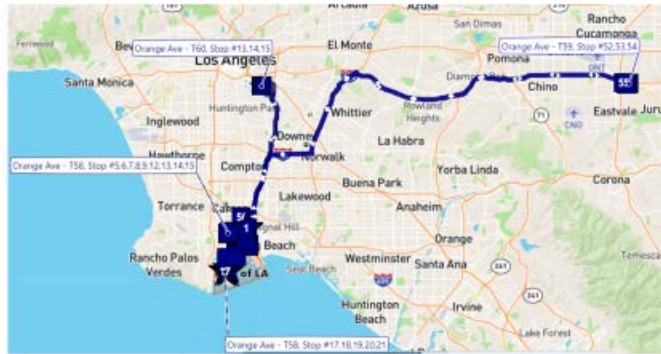

9

Pac9



7

Pac9

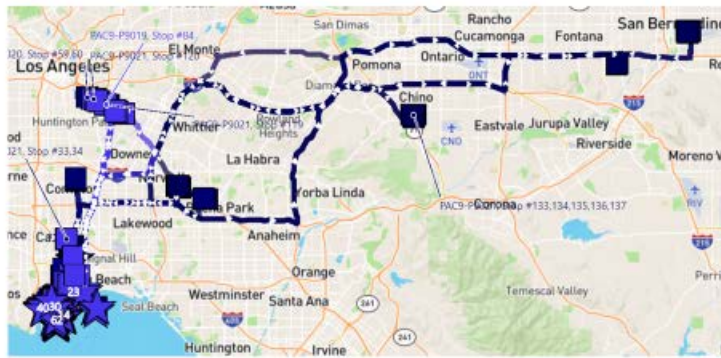

7

Pac9



7

Pac9

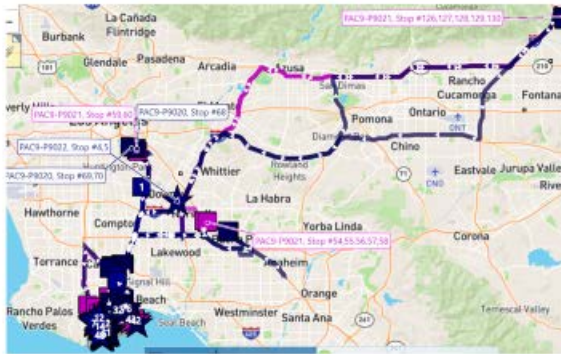

7

Pac9

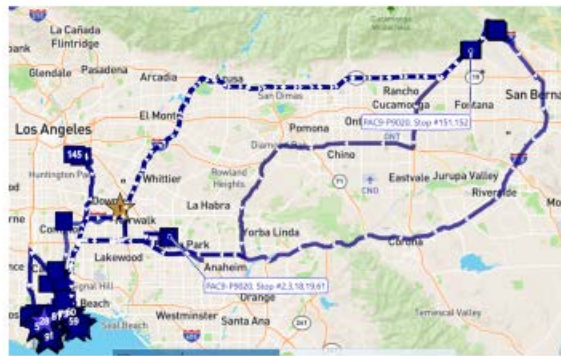

7

TTSI



5

TTSI

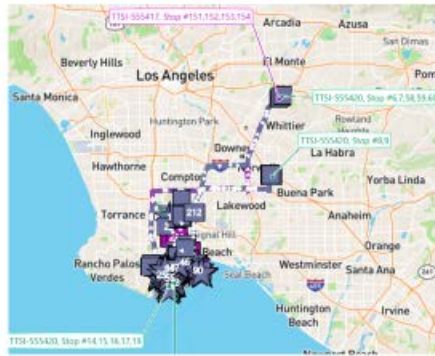

5

TTSI

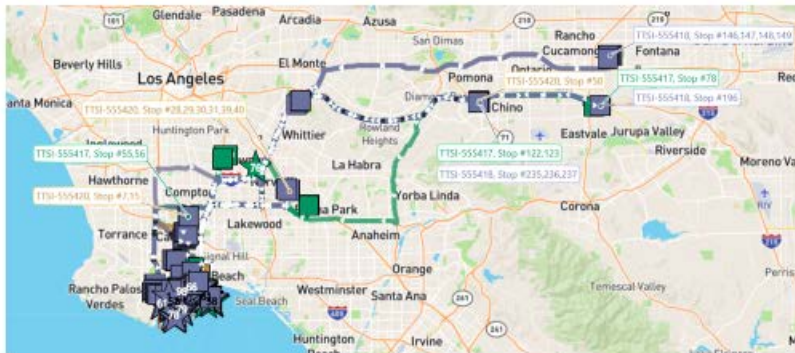

5

TTSI



5

TTSI



5

TTSI



5

Appendix 3

Fleet & Driver Orientation and Training Handout



CEC-AQMD Low NOx Truck Demonstration Project

Kick-off Orientation & Training

Project Team

- CEC & AQMD – Project Funding
- Clean Energy – Grant Administration, Grant Reporting, Fuel
- Cummins Westport – Low NOx Engine, Repower, Engine Maintenance & Repair
- Agility Fuel Systems – CNG Fuel System Maintenance & Repair
- Rush Peterbilt – Truck Service & Support

Customer Service Hotlines

| | |
|---------------------------------|--|
| Cummins – Engine Concerns | Freddy Ruiz 866 934 4373, then hit 3, then hit 3 again Freddy.ruiz@cummins.com |
| Agility – Fuel System Concerns | 855-500-2445 or 946-267-7745 support@agilityfs.com |
| Clean Energy – Fueling Concerns | 866-809-4869 customerservice@cleanenergyfuels.com |

Driving a Natural Gas Truck

The natural gas truck is similar to a diesel but has differences. There is no regen. Engine is much quieter. Driver needs to shift gears at higher RPM than a diesel.

Truck Maintenance

- Daily Inspection by Operator – Check for physical damage of the tank cabinet, confirm red safety caps are on each of the pressure relief vent lines, and drain the two engine fuel filters.
- Engine and emissions control system maintenance and repair is provided by Cummins during the 12 month project including standard interval maintenance (oil changes, spark plugs, etc.). Cummins will monitor engine hours and notify customer of maintenance schedule.
- CNG fuel system is covered by 12 month system warranty by Agility.

Fueling

Fuel consumption will be tracked for each truck using the Clean Energy fuel cards. Assign fuel cards to a specific truck so that we know fuel was consumed by the truck.

Reporting

- Orientation phone call will be held with Allison Geane of Clean Energy
- Monthly Reports – Submit data by the 7th day of each month

Contacts

| | | |
|--|---|--|
| <p>Clean Energy Greg Roche (949) 377-8119 greg.roche@cleanenergyfuels.com</p> <p>Allison Geane (949) 437-1323 Allison.geane@cleanenergyfuels.com</p> <p>Nadia Ramirez (562) 252-5856 nadia.ramirez@cleanenergyfuels.com</p> | <p>Cummins Matt Lamping (812) 374-7787 matthew.lamping@cummins.com</p> <p>Kurt Hintz (562) 419-6373 kurt.hintz@cummins.com</p> <p>Tom Swenson (916) 376-1529 tom.swenson@cummins.com</p> | <p>Agility Fuel Solutions Dave Pilarcik (951) 545-3103 dave.pilarcik@agilityfs.com</p> <p>Yoshio Coy (949) 441-0424 YCoy@agilityfs.com</p> <p>Charles Racic (949) 324-6746 charles.racic@agilityfuelsolutions.com</p> |
|--|---|--|

Appendix 4

Final Project Dashboard

Reports



South Coast Air Quality Management District
Southern California Trucking Demonstration of Near-Zero ISX12-G Engines
Final Report - Contract No. 18122 - Clean Fuels/CEC



Near-Zero Demonstration Project Summary

Results Through June 2019

Funding Agencies

California Energy Commission
South Coast AQMD

Project Implementation

Clean Energy
Cummins Westport and Cummins
Agility Fuel Solutions

| Operating Results | Trucks | Total Miles Traveled | Miles Per Truck (Ave) | Total Fuel Used (DGE) | Average Idle Time % | Ave. Fuel Economy (MPDGE) | NOx Reduced (US Pounds) | GHG Reduced (US Tons) |
|-------------------|-----------|----------------------|-----------------------|-----------------------|---------------------|---------------------------|-------------------------|-----------------------|
| TTSI | 4 | 164,271 | 41,068 | 44,826 | 27% | 3.7 | 2,321.7 | 297.4 |
| Pac9 | 4 | 80,571 | 20,143 | 16,029 | 29% | 5.0 | 1,138.7 | 112.5 |
| CR&R | 1 | 45,369 | 45,369 | 8,119 | 24% | 5.6 | 653.0 | 57.2 |
| 4 Gen | 3 | 80,754 | 26,918 | 18,362 | 22% | 4.4 | 1,116.2 | 121.3 |
| Orange Ave | 3 | 21,128 | 7,043 | 6,234 | 32% | 3.4 | 298.6 | 44.0 |
| NFI | 4 | 142,761 | 35,690 | 29,195 | 27% | 4.9 | 2,017.7 | 206.1 |
| Green Fleet | 1 | 32,749 | 32,749 | 6,908 | 18% | 4.7 | 488.0 | 48.7 |
| Totals | 20 | 567,603 | 28,380 | 129,674 | 26% | 4.4 | 8,033.8 | 887.3 |

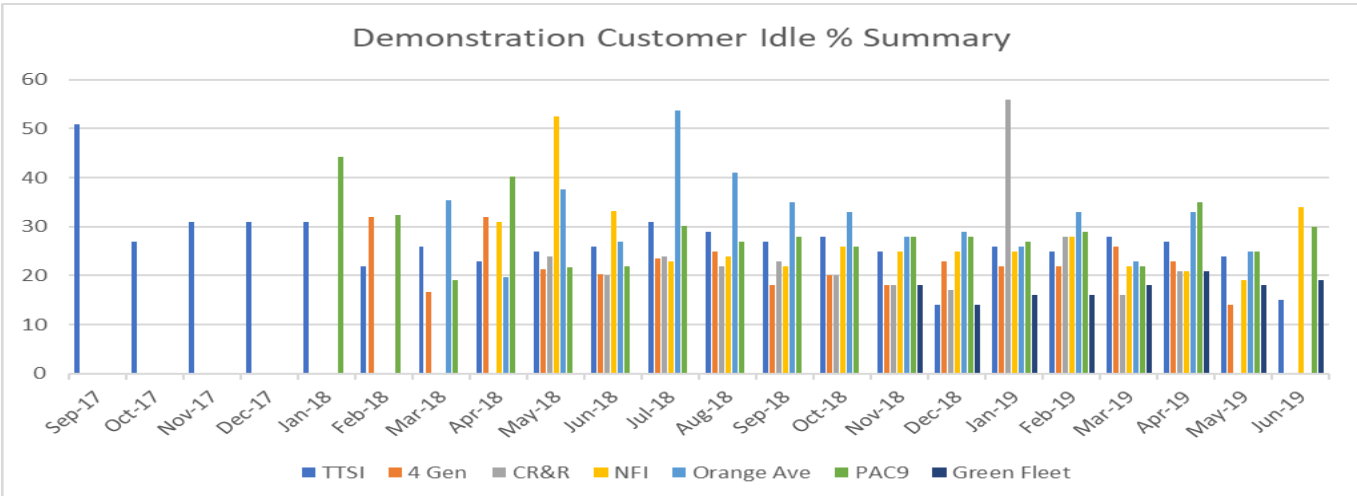
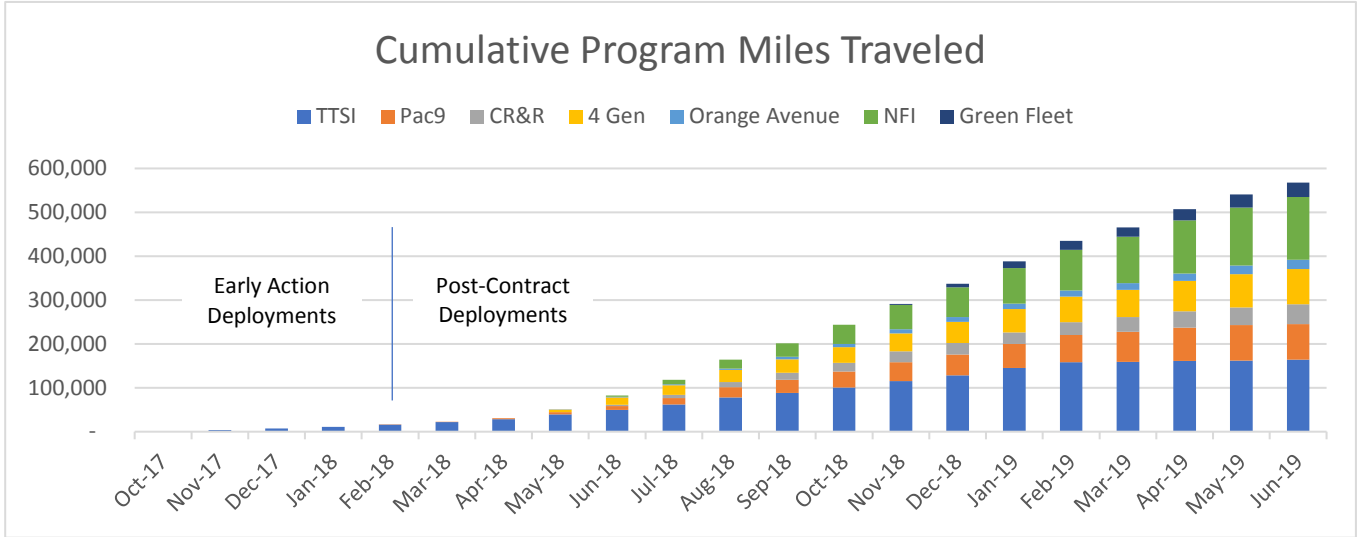

TTSI Near-Zero Demonstration Project Summary

Results Through June 2019

Funding Agencies

California Energy Commission
South Coast AQMD

Project Implementation

Clean Energy
Cummins Westport and Cummins
Agility Fuel Solutions

| Operating Results | Total Miles Traveled | Total Fuel Use (DGE) | Average Idle Time % | Fuel Economy (MPDGE) | NOx Reduced (US Pounds) | GHG Reduced (US Tons) |
|-------------------|----------------------|----------------------|---------------------|----------------------|-------------------------|-----------------------|
| 555417 | 44,158 | 11,768 | 21% | 3.8 | 624.1 | 76.2 |
| 555418 | 55,374 | 15,696 | 28% | 3.5 | 782.6 | 106.0 |
| 555420 | 43,190 | 12,610 | 23% | 3.4 | 610.4 | 81.7 |
| CECNG7972 | 21,548 | 4,753 | 25% | 4.5 | 304.5 | 33.6 |
| Totals | 164,271 | 44,826 | 24% | 3.7 | 2321.7 | 297.4 |

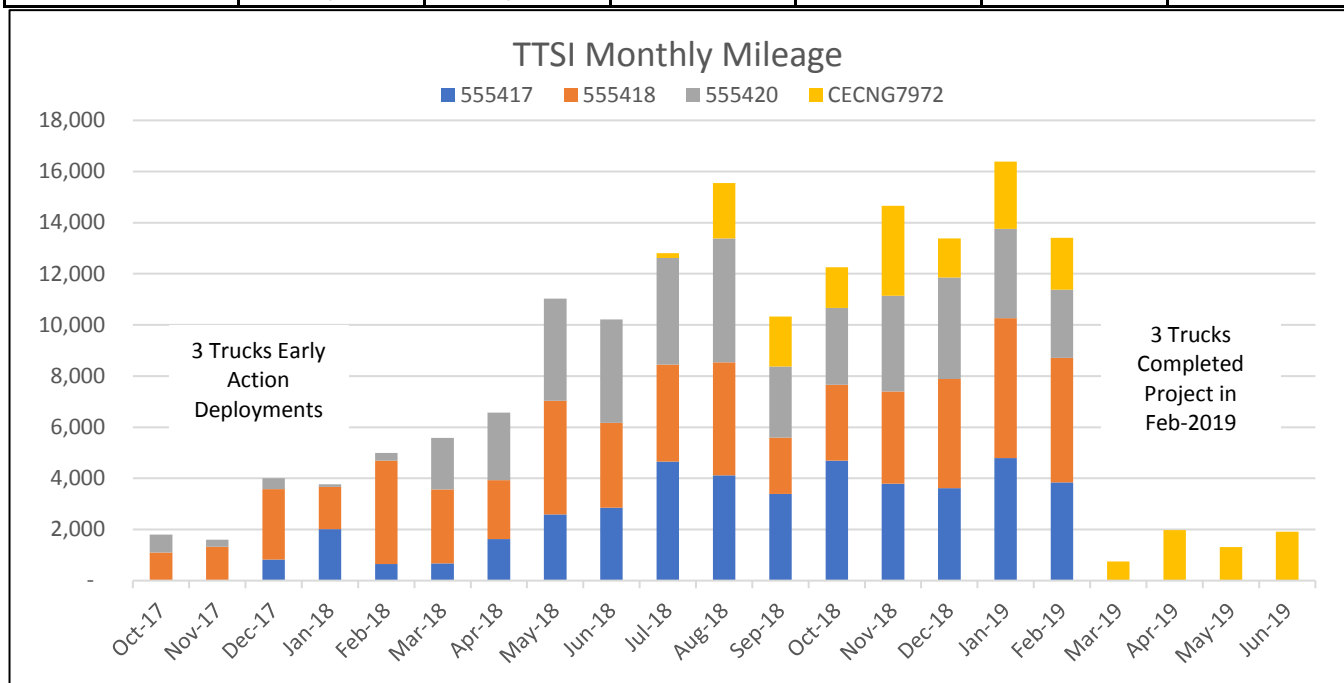

Pac9 Near-Zero Demonstration Project Summary

Results Through June 2019

Funding Agencies

California Energy Commission
South Coast AQMD

Project Implementation

Clean Energy
Cummins Westport and Cummins
Agility Fuel Solutions

| Operating Results | Total Miles Traveled | Total Fuel Use (DGE) | Average Idle Time % | Fuel Economy (MPDGE) | NOx Reduced (US Pounds) | GHG Reduced (US Tons) |
|-------------------|----------------------|----------------------|---------------------|----------------------|-------------------------|-----------------------|
| P9019 | 20,824 | 4,288 | 28% | 4.9 | 294.3 | 29.9 |
| P9020 | 15,614 | 4,346 | 33% | 3.6 | 220.7 | 30.3 |
| P9021 | 22,394 | 3,336 | 26% | 6.7 | 316.5 | 23.6 |
| P9022 | 21,739 | 4,060 | 24% | 5.4 | 307.2 | 28.7 |
| Totals | 80,571 | 16,029 | 28% | 5.0 | 1138.7 | 112.5 |

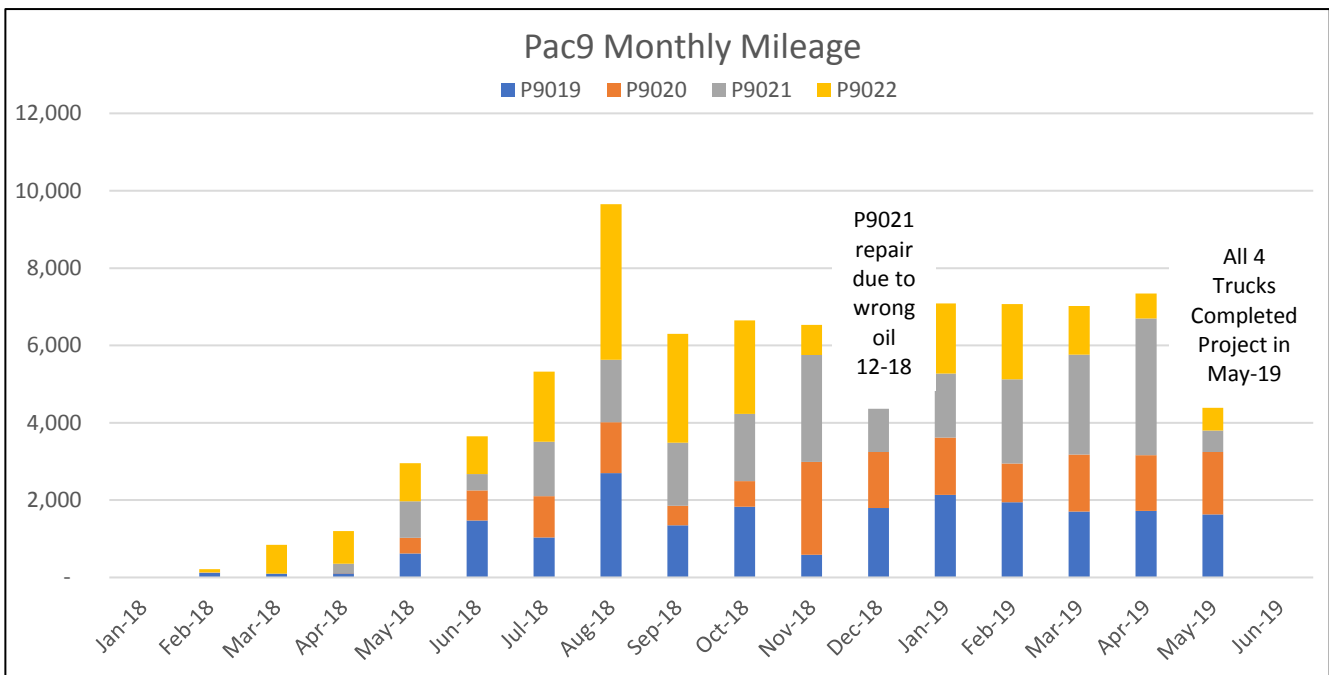

CR&R Near-Zero Demonstration Project Summary

Results Through June 2019

Funding Agencies

California Energy Commission
South Coast AQMD

Project Implementation

Clean Energy
Cummins Westport and Cummins
Agility Fuel Solutions

| Operating Results | Total Miles Traveled | Total Fuel Use (DGE) | Average Idle Time % | Fuel Economy (MPDGE) | NOx Reduced (US Pounds) | GHG Reduced (US Tons) |
|-------------------|----------------------|----------------------|---------------------|----------------------|-------------------------|-----------------------|
| CR&R_1 | 45,369 | 8,119 | 26% | 5.6 | 653.0 | 57.2 |
| Totals | 45,369 | 8,119 | 26% | 5.6 | 653.0 | 57.2 |

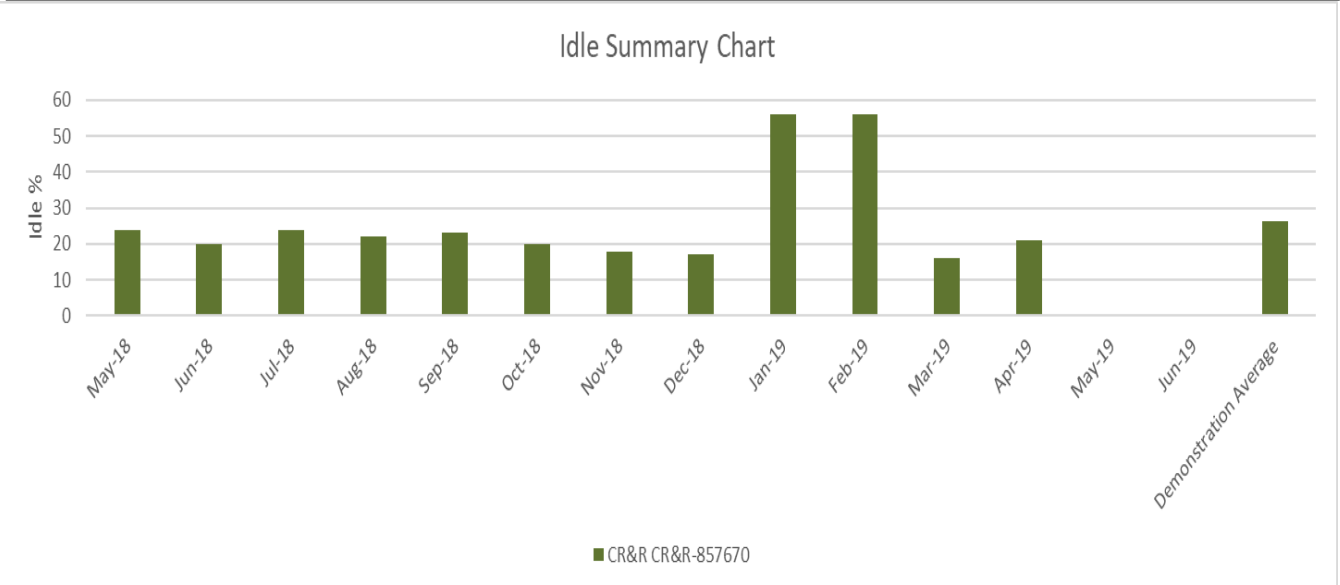
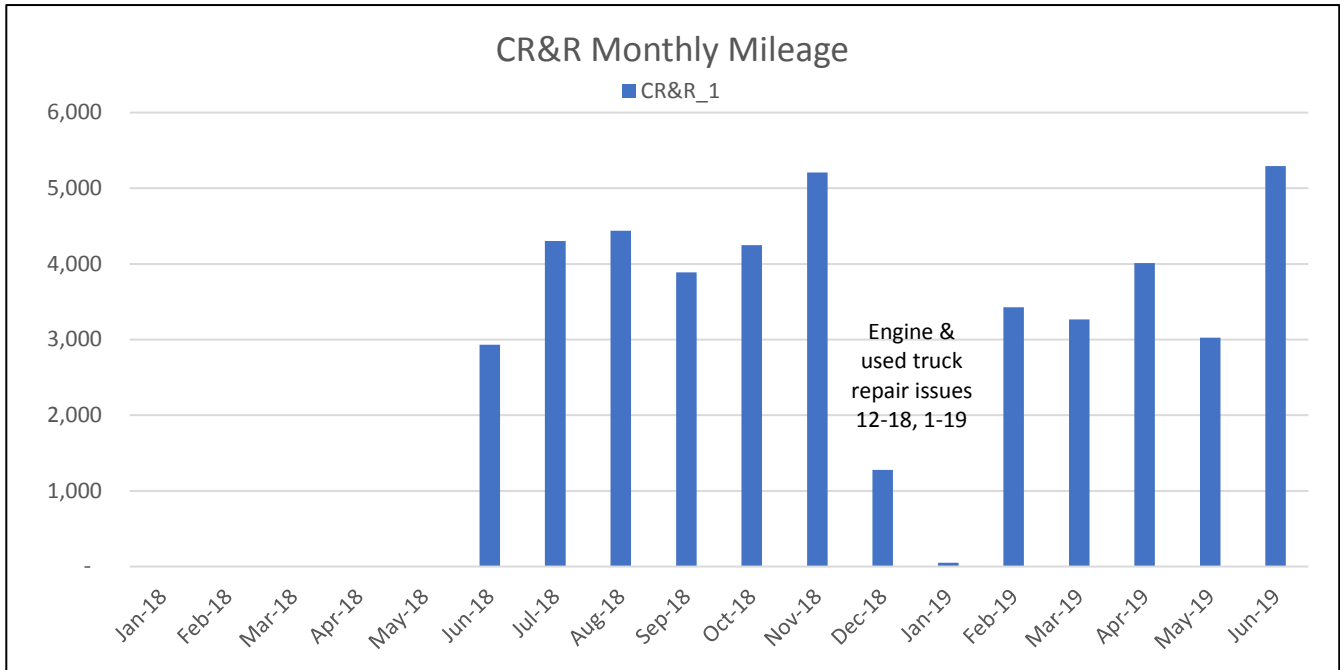

4Gen Near-Zero Demonstration Project Summary

Results Through June 2019

Funding Agencies

California Energy Commission
South Coast AQMD

Project Implementation

Clean Energy
Cummins Westport and Cummins
Agility Fuel Solutions

| Operating Results | Total Miles Traveled | Total Fuel Use (DGE) | Average Idle Time % | Fuel Economy (MPDGE) | NOx Reduced (US Pounds) | GHG Reduced (US Tons) |
|-------------------|----------------------|----------------------|---------------------|----------------------|-------------------------|-----------------------|
| 9027 | 16,133 | 3,323 | 18% | 4.9 | 228.0 | 23.4 |
| 9026 | 1,778 | 284 | 28% | 6.3 | 0.0 | 0.0 |
| 9028 | 39,631 | 8,639 | 21% | 4.6 | 560.1 | 55.2 |
| 9025 | 23,212 | 6,116 | 26% | 3.8 | 328.1 | 42.7 |
| Totals | 80,754 | 18,362 | 23% | 4.4 | 1116.2 | 121.3 |

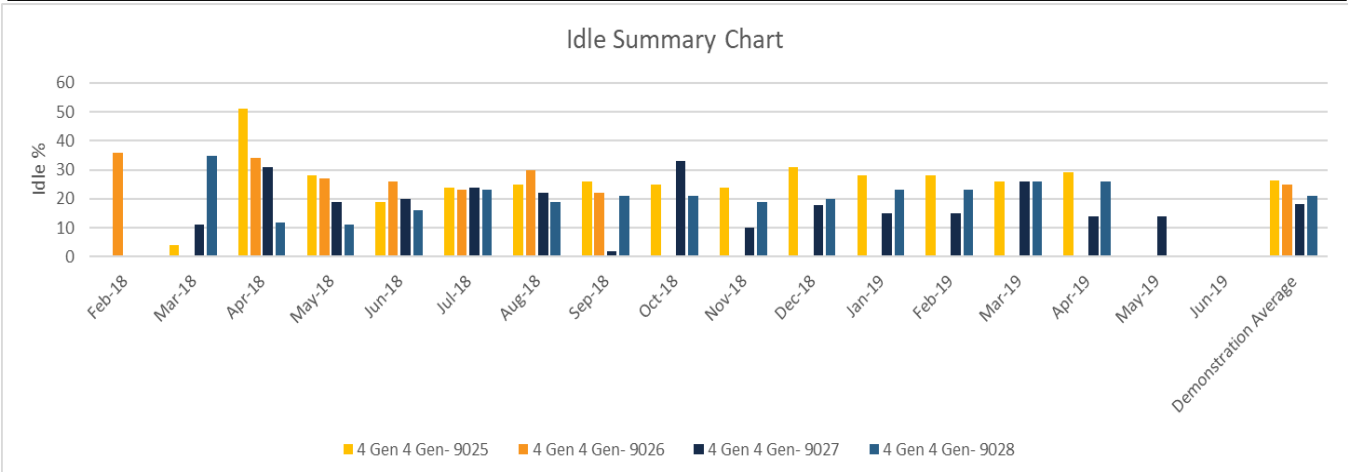
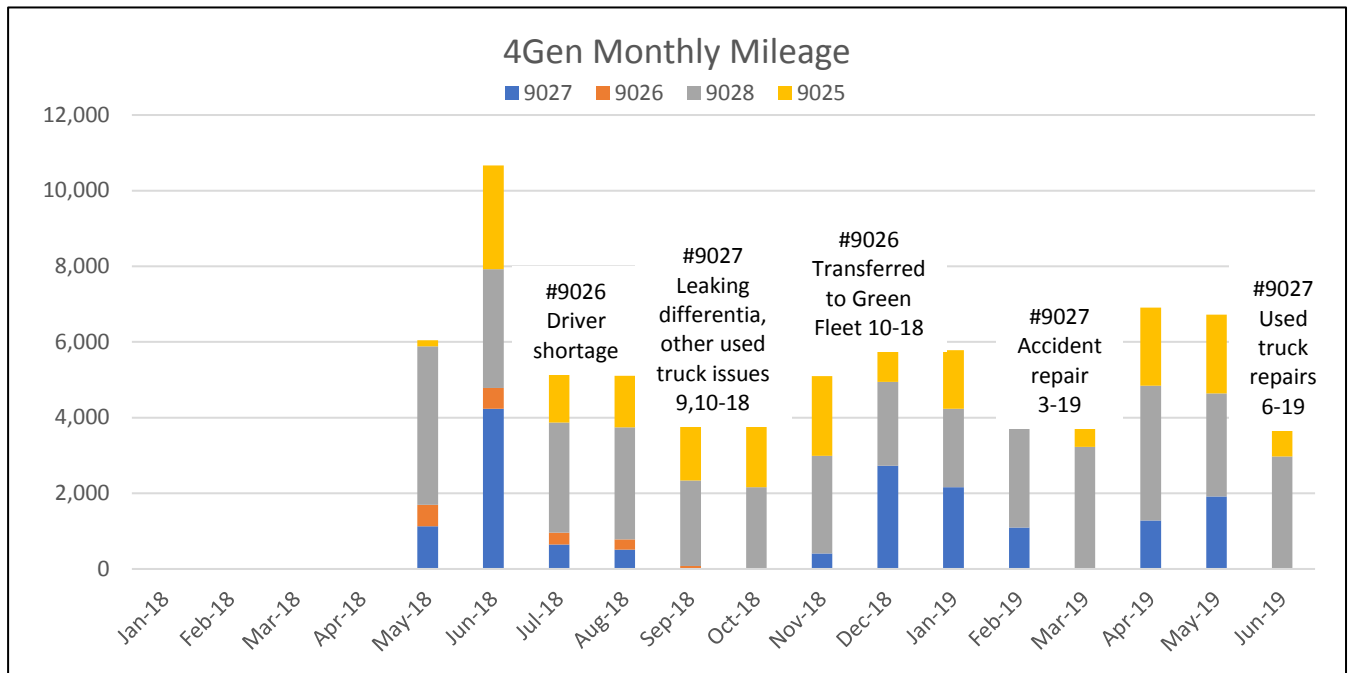

Orange Avenue Near-Zero Demonstration Project Summary

Results Through June 2019

Funding Agencies

California Energy Commission
South Coast AQMD

Project Implementation

Clean Energy
Cummins Westport and Cummins
Agility Fuel Solutions

| Operating Results | Total Miles Traveled | Total Fuel Use (DGE) | Average Idle Time % | Fuel Economy (MPDGE) | NOx Reduced (US Pounds) | GHG Reduced (US Tons) |
|-------------------|----------------------|----------------------|---------------------|----------------------|-------------------------|-----------------------|
| T59 | 5,918 | 1,738 | 32% | 3.4 | 83.6 | 12.2 |
| T60 | 8,598 | 2,656 | 28% | 3.2 | 121.5 | 18.8 |
| T58 | 6,612 | 1,839 | 34% | 3.6 | 93.4 | 13.0 |
| Totals | 21,128 | 6,234 | 31% | 3.4 | 298.6 | 44.0 |

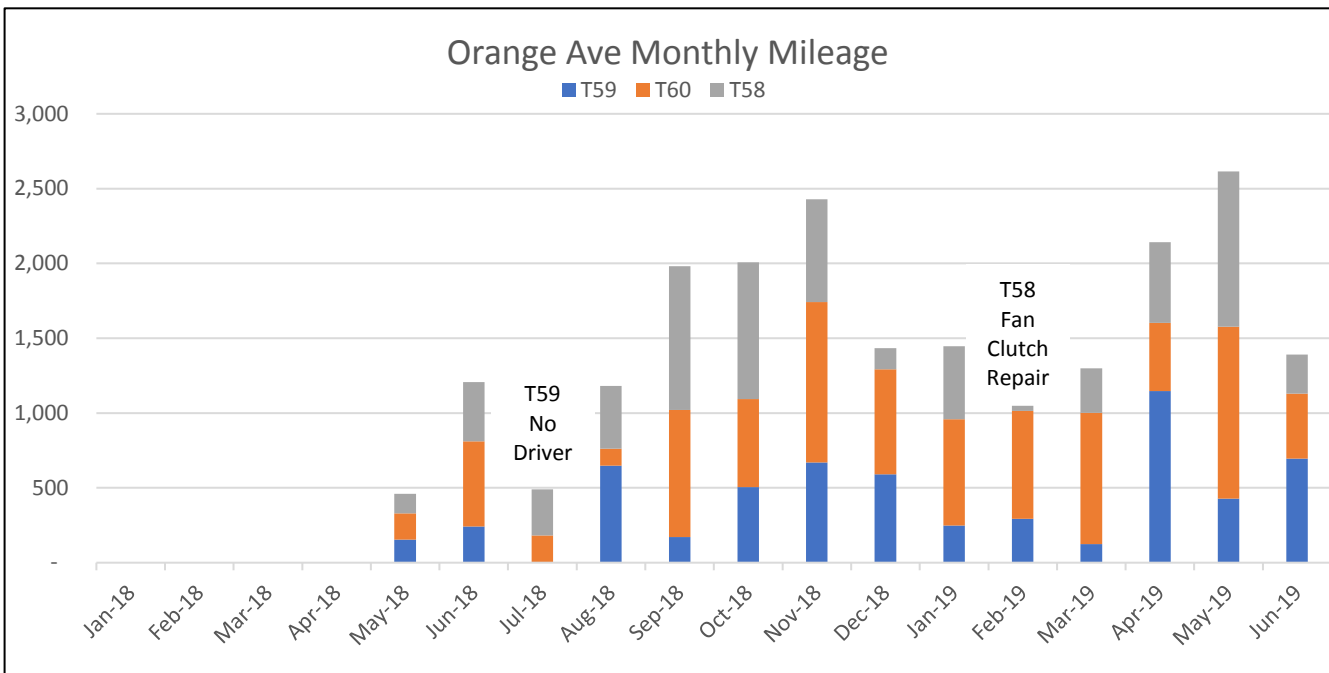

NFI Near-Zero Demonstration Project Summary

Results Through June 2019

Funding Agencies

California Energy Commission

South Coast AQMD

Project Implementation

Clean Energy

Cummins Westport and Cummins

Agility Fuel Solutions

| Operating Results | Total Miles Traveled | Total Fuel Use (DGE) | Average Idle Time % | Fuel Economy (MPDGE) | NOx Reduced (US Pounds) | GHG Reduced (US Tons) |
|-------------------|----------------------|----------------------|---------------------|----------------------|-------------------------|-----------------------|
| 545001 | 36,527 | 6,872 | 24% | 5.3 | 516.2 | 48.6 |
| 545003 | 38,267 | 7,772 | 23% | 4.9 | 540.8 | 54.8 |
| 545002 | 31,602 | 6,642 | 27% | 4.8 | 446.6 | 46.9 |
| 545004 | 36,365 | 7,909 | 30% | 4.6 | 514.0 | 55.8 |
| Totals | 142,761 | 29,195 | 26% | 4.9 | 2017.7 | 206.1 |

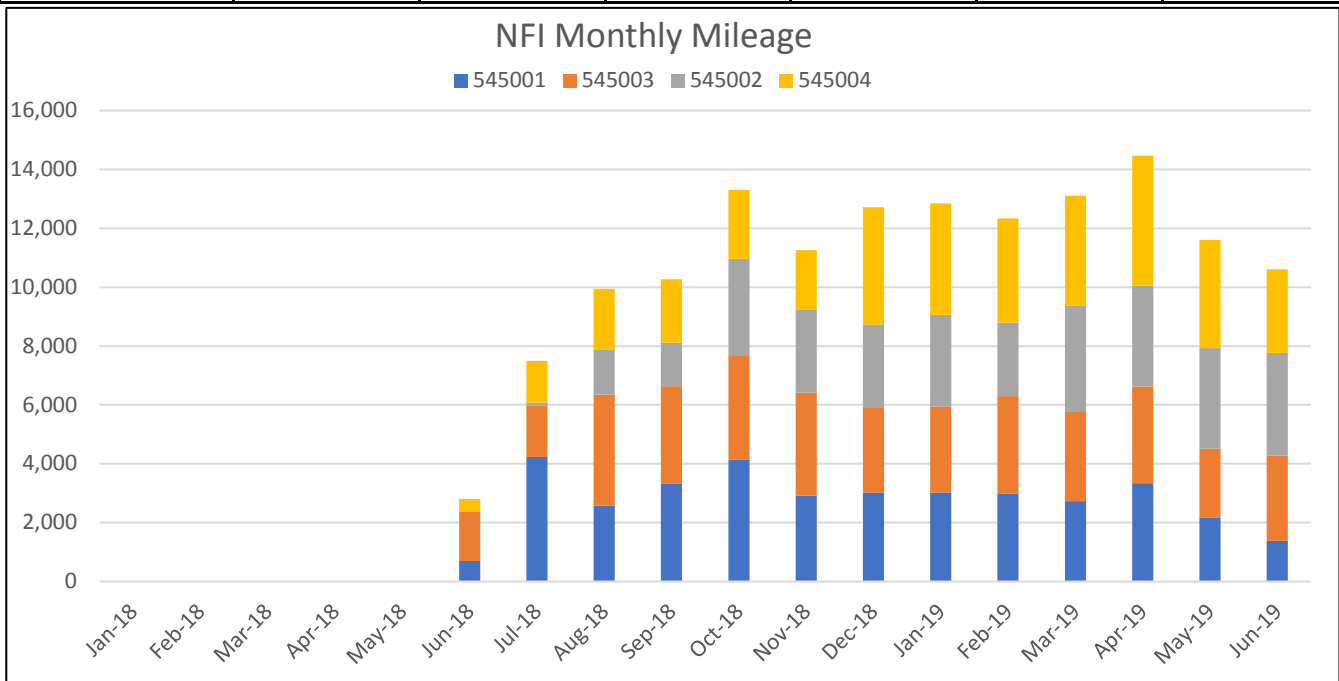

Green Fleet Systems Near-Zero Demonstration Project Summary

Results Through June 2019

Funding Agencies

California Energy Commission
South Coast AQMD

Project Implementation

Clean Energy
Cummins Westport and Cummins
Agility Fuel Solutions

| Operating Results | Total Miles Traveled | Total Fuel Use (DGE) | Average Idle Time % | Fuel Economy (MPDGE) | NOx Reduced (US Pounds) | GHG Reduced (US Tons) |
|-------------------|----------------------|----------------------|---------------------|----------------------|-------------------------|-----------------------|
| 50 | 32,749 | 6,908 | 18% | 4.7 | 488.0 | 48.7 |
| Totals | 32,749 | 6,908 | 18% | 4.7 | 488.0 | 48.7 |

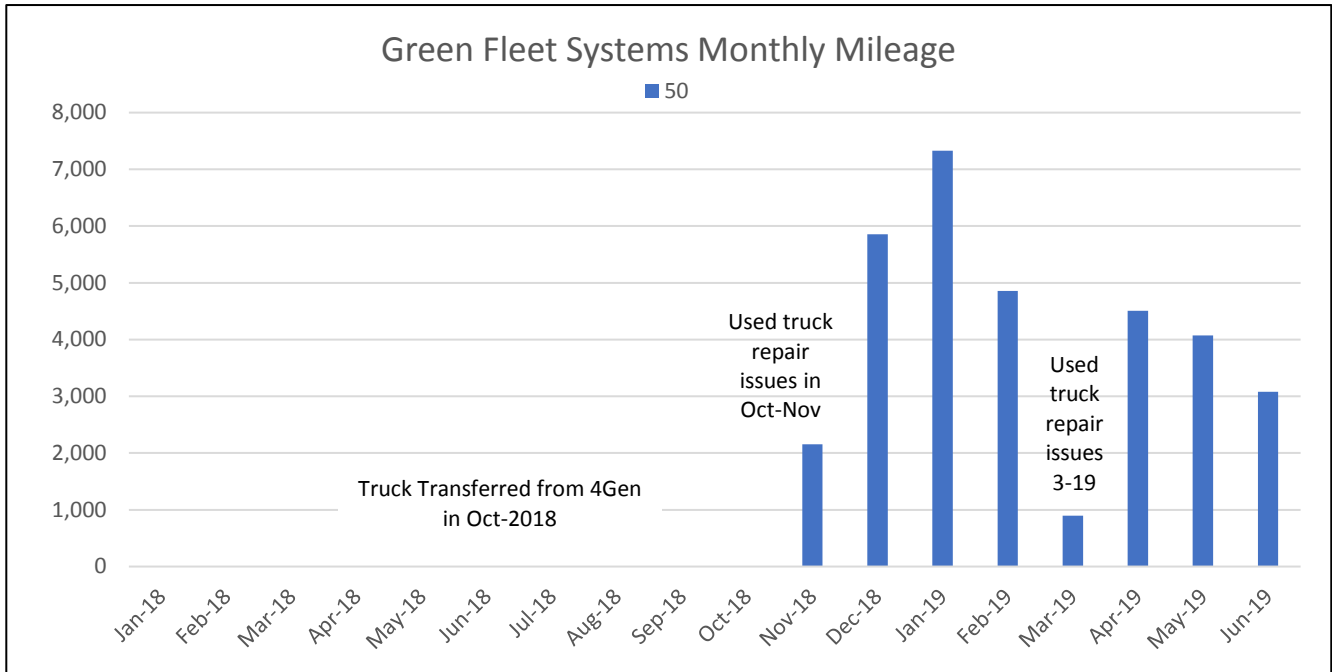

Appendix 5

Driver Survey #1

Instrument



Driver Survey #1

Near-Zero Port Truck Demonstration Project

Company Name: _____

Driver Name (Optional): _____

Select the demo truck you are driving:

____ Freightliner LNG with Automatic Transmission

____ Peterbilt CNG with Manual Transmission

Truck ID if you drive the same demo truck each day: _____

What type of truck did you drive before the Near-Zero demonstration truck?

Truck Brand: _____

Engine Brand, Size, Horsepower: _____

Please circle your answer to the questions. 1 = lowest rating, 2 = middle rating, 3 = best rating

| | When You First Began Driving the Truck | How You Feel About the Truck Today |
|---|--|------------------------------------|
| Truck Questions | | |
| How comfortable is the truck? | 1 2 3 | 1 2 3 |
| Do you like the truck brand? | 1 2 3 | 1 2 3 |
| Do you prefer manual or automatic transmission? | Automatic Manual | Automatic Manual |
| Engine Questions | | |
| How well does the engine pull loads? | 1 2 3 | 1 2 3 |
| How is the acceleration of the engine? | 1 2 3 | 1 2 3 |
| Is the engine quiet? | 1 2 3 | 1 2 3 |
| How well do you like the clean air engine? | 1 2 3 | 1 2 3 |
| Fuel Questions | | |
| How do you like CNG fuel (Peterbilt trucks)? | 1 2 3 | 1 2 3 |
| How do you like LNG fuel (Freightliner trucks)? | 1 2 3 | 1 2 3 |
| How easy is fueling the truck? | 1 2 3 | 1 2 3 |
| How reliable are the fueling stations? | 1 2 3 | 1 2 3 |

Other Comments: _____

Appendix 6

Driver Survey #2

Instrument (English & Spanish)



Encuesta de Conductor #2

Proyecto de Demostración de Camiones Portuarios Cercanos a Cero

Nombre de la empresa: _____

Nombre del conductor (opcional): _____

(1) Seleccione el camión de muestra que maneja:

_____ Freightliner LNG con Transmisión Automática

_____ Peterbilt CNG con Transmisión Manual

ID del camión si tiene el mismo camión de demostración cada día: _____

Haga un círculo con su respuesta a las preguntas. 1 – calificación más baja, 2 – calificación media, 3 – mejor calificación.

(2) Califique el camión (no el motor).

- | | | | |
|--|---|---|---|
| 1. ¿Qué tan cómodo es el camión? | 1 | 2 | 3 |
| 2. ¿Cuánto te gusta la marca de el camión? | 1 | 2 | 3 |
| 3. ¿Qué tan confiable es el camión? | 1 | 2 | 3 |

(3) Califique el camión y el combustible.

- | | | | |
|--|---|---|---|
| 1. ¿Qué tan bien se carga el motor? | 1 | 2 | 3 |
| 2. ¿Cómo es la aceleración del motor? | 1 | 2 | 3 |
| 3. ¿Qué te parece la quietud del motor? | 1 | 2 | 3 |
| 4. ¿Qué tan bien te gusta el motor? | 1 | 2 | 3 |
| 5. ¿Qué tan fácil es alimentar el camión (de combustible)? | 1 | 2 | 3 |
| 6. ¿Qué tan fiables son las estaciones de combustible? | 1 | 2 | 3 |

(4) Considerando la capacidad de conducción, el rendimiento, la tranquilidad, el combustible, su salud y bienestar, y el medio ambiente, ¿qué tan probable recomendaría un camión de gas natural a otros conductores?

1. Definitivamente si
2. Probablemente si
3. No

(5) ¿Qué destino(s) viajó su camión durante el proyecto? Proporcione una calificación de lo bien que se han realizado los camiones para sus rutas. 1 - calificación más baja, 2 - calificación media, 3 - mejor calificación

- | | | | | |
|-----------------------|---|---|---|--------------|
| 1. Cerca del Puerto: | 1 | 2 | 3 | No aplicable |
| 2. Hasta el área 710: | 1 | 2 | 3 | No aplicable |
| 3. Inland Empire: | 1 | 2 | 3 | No aplicable |
| 4. Valle Central: | 1 | 2 | 3 | No aplicable |
| 5. Otros | 1 | 2 | 3 | No aplicable |

Explicar Otro: _____

(6) ¿Cuál fue la carga más pesada que recuerdas acarrear?

1. 60,000 a 70,000 GVW
2. 70,000 a 75,000 GVW
3. 75,000 a 80,000 GVW

(7) Por favor describa la ruta más difícil a la que puso el camión a través (por ejemplo: subida de la colina, tráfico con paradas continuas, etc.) ¿Cuál era la carga aproximada en esta ruta? ¿Cómo funcionó el motor en esta ruta? Proporcione una calificación sobre el rendimiento del camión para su ruta. 1 - calificación más baja, 2 - calificación media, 3 - mejor calificación

Ruta: _____

Carga: _____ GVW

Calificación: 1 2 3

(8) ¿El camión proporcionó confianza en que puede hacer el trabajo?

1. Sí
2. No

(9) ¿Qué es lo más importante para usted a medida que se transporta desde el puerto cuando se trata del camión que está operando?

1. Comodidades del vehículo (aire acondicionado, electrónica, transmisión automática, etc.)
2. Asegurarse de que esta operando un camión de emisiones limpias
3. Potencia del motor
4. Fiabilidad del camión

(10) ¿Qué tipo de camión diésel ha operado normalmente en el pasado?

Marca de camión: ____ Freightliner ____ Peterbilt ____ Kenworth ____ Volvo ____ Mack ____ Navistar

Tamaño del motor: ____ <400 HP ____ 400 HP a 450 HP ____ 450 a 500 HP ____ > 500 HP

(11) ¿Ha operado otros camiones de combustible alternativos antes?

1. Sí
2. No

En caso afirmativo, proporcione las millas aproximadas que condujo el camión y califique su experiencia. 1 – calificación más baja, 2 – calificación media, 3 – mejor calificación

Gas Natural: _____mi Calificación: 1 2 3

Gas Natural Híbrido: _____mi Calificación: 1 2 3

Batería Eléctrica _____mi Calificación: 1 2 3

Combustible de hidrógeno _____mi Calificación: 1 2 3

Propano _____mi Calificación: 1 2 3

¡Gracias por su participación!

Driver Survey #2

Near-Zero Port Truck Demonstration Project

Company Name: _____

Driver Name (Optional): _____

(1) Select the demo truck you drove:

_____ Freightliner LNG with Automatic Transmission

_____ Peterbilt CNG with Manual Transmission

Truck ID if you have the same demo truck each day: _____

Circle your answer to the questions. 1 = lowest rating, 2 = middle rating, 3 = best rating

(2) Please rate the truck (not the engine).

- | | | | |
|--|---|---|---|
| 1. How comfortable is the truck? | 1 | 2 | 3 |
| 2. How much do you like the truck brand? | 1 | 2 | 3 |
| 3. How reliable is the truck? | 1 | 2 | 3 |

(3) Please rate the engine and fueling.

- | | | | |
|---|---|---|---|
| 1. How well does the engine pull loads? | 1 | 2 | 3 |
| 2. How is the acceleration of the engine? | 1 | 2 | 3 |
| 3. How do you like the quietness of the engine? | 1 | 2 | 3 |
| 4. How well do you like the engine? | 1 | 2 | 3 |
| 5. How easy is fueling the truck? | 1 | 2 | 3 |
| 6. How reliable are the fueling stations? | 1 | 2 | 3 |

(4) After considering drive-ability, performance, quietness, fueling, your health and well-being, and the environment, how likely would you recommend a natural gas truck to other drivers?

- 1) Definitely Yes
- 2) Likely Yes
- 3) No

(5) What destination(s) did your truck travel during the project? Provide a rating for how well the trucks performed for your routes. 1 = lowest rating, 2 = middle rating, 3 = best rating

- | | | | | |
|---------------------|---|---|---|----------------|
| 1) Nearby the port: | 1 | 2 | 3 | Not applicable |
| 2) Up the 710 area: | 1 | 2 | 3 | Not applicable |
| 3) Inland Empire: | 1 | 2 | 3 | Not applicable |
| 4) Central Valley: | 1 | 2 | 3 | Not applicable |
| 5) Other: | 1 | 2 | 3 | Not applicable |

Explain Other: _____

(6) What was the heaviest load you remember hauling?

- 1) 60,000 to 70,000 GVW
- 2) 70,000 to 75,000 GVW
- 3) 75,000 to 80,000 GVW

(7) Please describe the toughest route you put the truck through (e.g. hill climb, stop/go traffic)? What was the approximate load on this route? How did the engine perform on this route? Provide a rating on how well the truck performed for your route. 1 = lowest rating, 2 = middle rating, 3 = best rating

Route: _____

Load: _____ GVW

Rating: 1 2 3

(8) Did the truck provide confidence that it can get the job done?

- 1) Yes
- 2) No

(9) What is most important to you as you haul from the port when it comes to the truck you are operating?

- 1) Vehicle comforts (air conditioning, electronics, automatic transmission, etc.)
- 2) Ensuring you are operating a clean emissions truck
- 3) Engine horsepower
- 4) Truck reliability

(10) What type of diesel truck have you typically operated in the past?

Truck Brand: ___ Freightliner ___ Peterbilt ___ Kenworth ___ Volvo ___ Mack ___ Navistar

Engine Size: ___ <400 HP ___ 400 HP to 450 HP ___ 450 to 500 HP ___ > 500 HP

(11) Have you operated other alternative fuel trucks before?

- 1) Yes
- 2) No

If yes, please provide the approximate miles that you drove the truck and rate your experience. 1 = lowest rating, 2 = middle rating, 3 = best rating

Natural Gas: _____ mi Rating: 1 2 3

Natural Gas Hybrid: _____ mi Rating: 1 2 3

Battery Electric: _____ mi Rating: 1 2 3

Hydrogen Fuel Cell: _____ mi Rating: 1 2 3

Propane: _____ mi Rating: 1 2 3

Thank you for your participation!

Appendix 7

Fleet Survey Instrument



South Coast Air Quality Management District
Southern California Trucking Demonstration of Near-Zero ISX12-G Engines
Final Report - Contract No. 18122 - Clean Fuels/CEC



Participating Company Exit Survey

Near-Zero Truck Demonstration Project

Company Name: _____

Your Name: _____

Select the demo truck(s) your company operated:

_____ Freightliner LNG with Automatic Transmission

_____ Peterbilt CNG with Manual Transmission

What type of truck do you typically operate that forms the comparison to the near-zero demonstration truck?

Truck Brand: _____ Freightliner _____ Peterbilt _____ Kenworth _____ Volvo _____ Mack _____ Navistar

Engine Size: _____ <400 HP _____ 400 HP to 450 HP _____ 450 to 500 HP _____ > 500 HP

How many trucks do you deploy on average each day? _____

Please provide some information on business and environmental considerations.

- 1) Do your customers offer you incentives or preferences to operate trucks with low emissions of air pollutants or climate pollutants? Circle all that apply.
 - a. Yes for air pollutants
 - b. Yes for climate pollutants
 - c. No

- 2) Does your company have a sustainability policy? If so, please explain the policy.

- a. Yes
 - b. No
- Explain:

Please answer the following questions as they relate to your experience with the near-zero demonstrations truck.

- 3) What was the typical load (GVW) of your demonstration truck(s)?

- a. Less than 60,000 lbs
- b. 60,000 to 65,000 lbs
- c. 65,000 to 70,000 lbs
- d. 70,000 to 75,000 lbs
- e. 75,000 to 80,000 lbs
- f. Above 80,000 lbs

- 4) What is the heaviest load (GVW) that you hauled with the demo truck?

- a. _____ lbs
- b. Do not know

- 5) Please mark the routes that the demo truck traveled and the suitability of the engine for each route from low suitability to high suitability. 1 = lowest rating, 2 = middle rating, 3 = best rating
- | | | | | |
|----------------------|---|---|---|----------------|
| a. Nearby the port: | 1 | 2 | 3 | Not applicable |
| b. Up the 710 areas: | 1 | 2 | 3 | Not applicable |
| c. Inland Empire: | 1 | 2 | 3 | Not applicable |
| d. Central Valley: | 1 | 2 | 3 | Not applicable |
| e. Other: | 1 | 2 | 3 | Not applicable |
- Explain Other: _____
- 6) What is your overall rating of the performance of the engine.
- Engine was able to perform for all of our routes and applications
 - Engine was able to perform for most of our routes and applications
 - Engine was only able to perform a portion of our routes and applications
- 7) What is your perception as to the overall cost to operate these trucks compared to a comparable age diesel truck?
- Higher than a comparable age diesel vehicle
 - The same as a comparable age diesel vehicle
 - Lower than a comparable age diesel vehicle
- 8) Did your vehicle experience downtime due to engine issues? If yes, was it:
- About the same as a comparable diesel
 - More often than a comparable diesel
 - Less often than a comparable diesel
- 9) How do your drivers feel about the near-zero demo truck?
- Prefer the near-zero truck over a comparable diesel
 - Prefer a comparable diesel over the near-zero truck
 - No preference between the near-zero truck and comparable diesel truck
- 10) What are you plans for purchasing additional natural gas trucks based on your experience in this project? Please circle all responses that match.
- Plan to purchase in 2019
 - Plan to purchase in 2020
 - Have already ordered trucks - _____ number of trucks
 - Have already taken delivery of trucks - _____ number of trucks
 - No plans to purchase additional trucks at this time

Thank You For Participating!

Appendix 8

Near Zero Demo Project

Update Presentation 10-23- 18



**CEC – AQMD
Near-Zero Truck
Demonstration Project**

**Ports of LA & Long Beach
Meeting
October 23, 2018**

Agenda

- Self Introductions
- Welcoming Remarks – AQMD & CEC
- Project Overview – Greg Roche
- Results to Date – Greg Roche
- Engine Results – Matthew Lamping
- Fuel System Results – Les Stinson
- Roundtable Discussion – Tom Swenson
- Truck Viewing



Project Background

- Purpose: Demonstrate the new 0.02 near-zero engine technology to the port trucking market
- Why:
 - High emissions from old port trucks operating in the most sensitive, impacted communities
 - ARB, AQMP and CAAP priorities & strategies seek to reduce emissions from port trucks
 - Port trucking apprehensions with new technologies given challenges with first generation technology from 10 years ago
- This was a separate project from the 2 “alpha” near-zero trucks deployed by TTSI in Q1 2017 with support from Ports of LA & Long Beach under the CWI near-zero field test program



Participants

- **California Energy Commission**
- **AQMD**
- **Clean Energy**
 - Grant administration & program management
 - RNG fuel
- **Cummins-Westport & Cummins**
 - Low NOx engines, repowers, service & support
- **Agility Fuel Solutions**
 - CNG fuel systems on 17 trucks
- **Participating Fleets**
 - Premier Transportation Service (TTSI)
 - CR&R
 - 4 Gen Logistics, LLC (Duncan & Son)
 - Pacific 9 Transportation, Inc.
 - Orange Avenue Express
 - NFI Interactive Logistics, LLC



Project Overview

- Acquire 20 used natural gas trucks with 12 liter engines
 - 3x2015 Freightliner LNG trucks and 17x2014 Peterbilt CNG trucks
- Repower with “beta” (pre-production) 0.02 low NOx engines & catalysts
- Deploy with leading trucking fleets primarily in the Ports of Los Angeles and Long Beach
- Operate the demonstration trucks for 12 months
- Collect data – operational, service, driver feedback
- Conduct weekly coordination meetings between Clean Energy, CWI and Agility
- Provide weekly feedback reports to participating fleets – mileage, idle time, routes
- Provide monthly and quarterly reports to CEC/AQMD
- Convert trucks to production level near-zero engines at the end of the project (outside the scope of this project but this is the intent)



Pictures



Dynamometer Test of TTSI Truck



Carlos - Happy 4Gen Driver!



CR&R Training (Nice Paint Job!)



Training at NFI



Pictures



CNG Fueling Training with Pac9



Orange Avenue Training



Truck Decals



Project-Dedicated Fuel Cards



Driver Survey #1 – Truck Questions

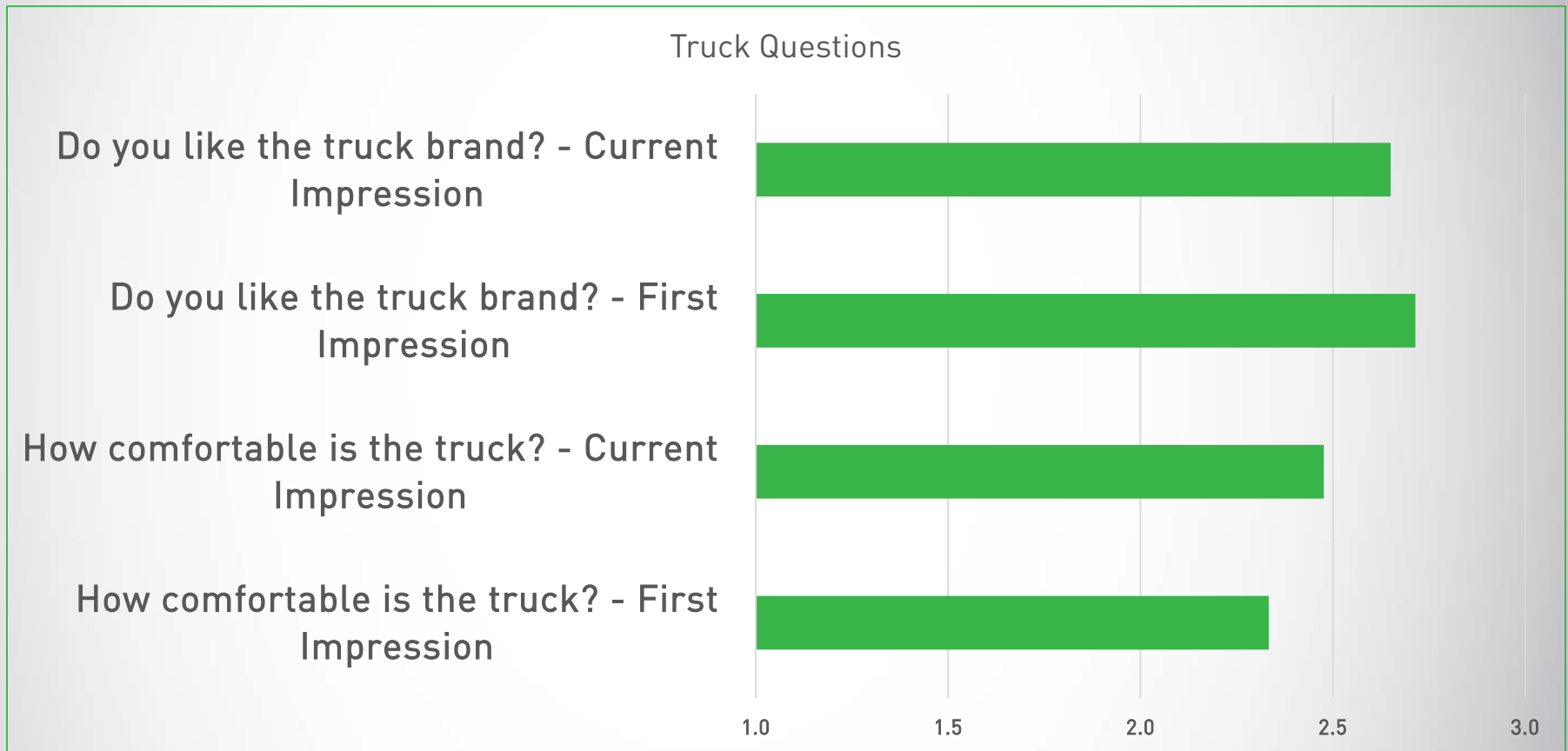

Average of 21 Responses
Survey Scale:
3 – Highest Rating
2 – Middle Rating
1 – Lowest Rating

Driver Comment:
Love It!

Only one driver rated the truck comfort or brand a “1”



Driver Survey #1 – Engine Questions

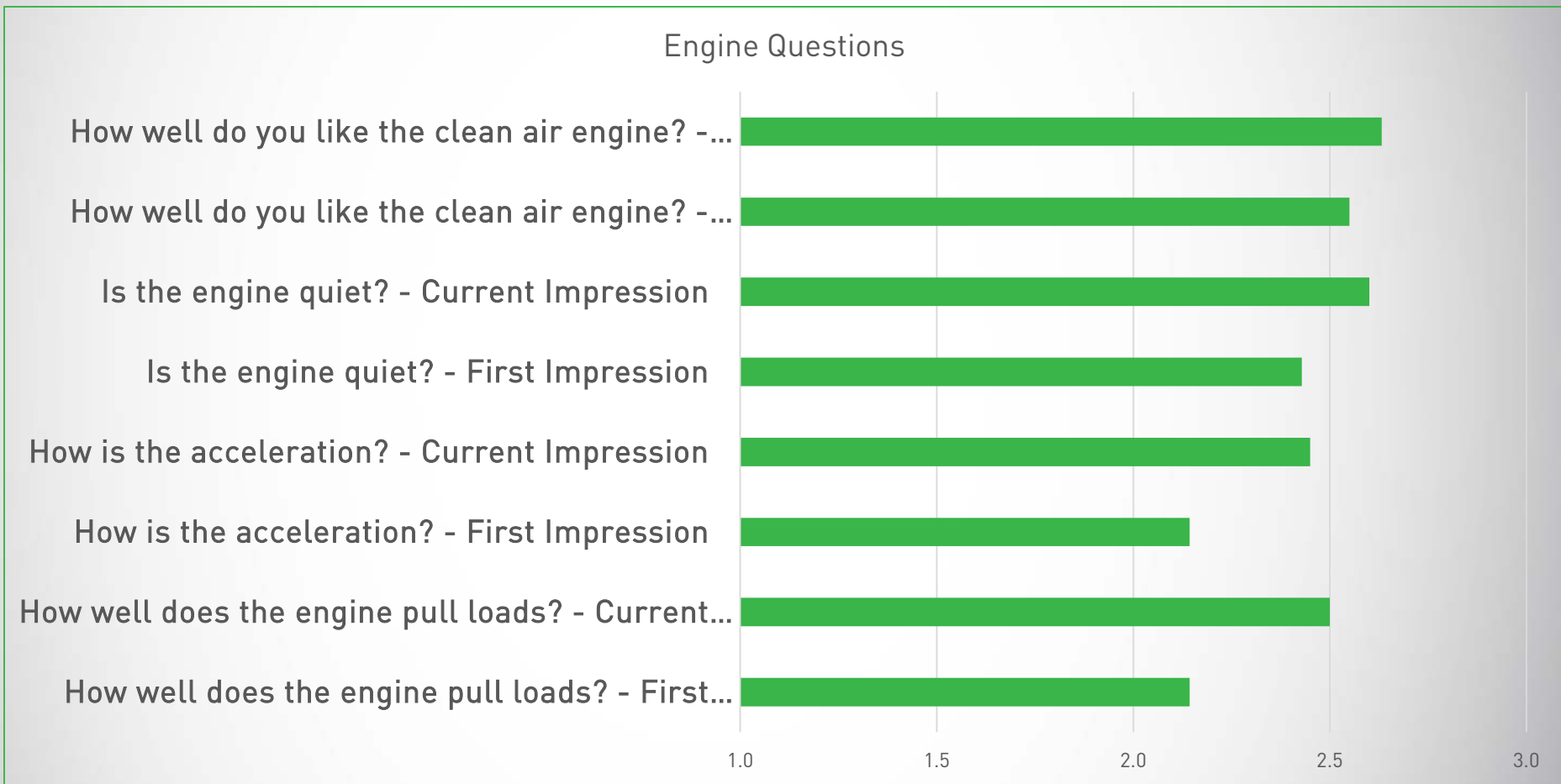

Average of 21 Responses

Survey Scale:

3 – Highest Rating

2 – Middle Rating

1 – Lowest Rating

Ratings were all 2 or 3 for first and current impressions.
There were no ratings of 1.



Driver Survey #1 – Fuel Questions

Fuel Questions

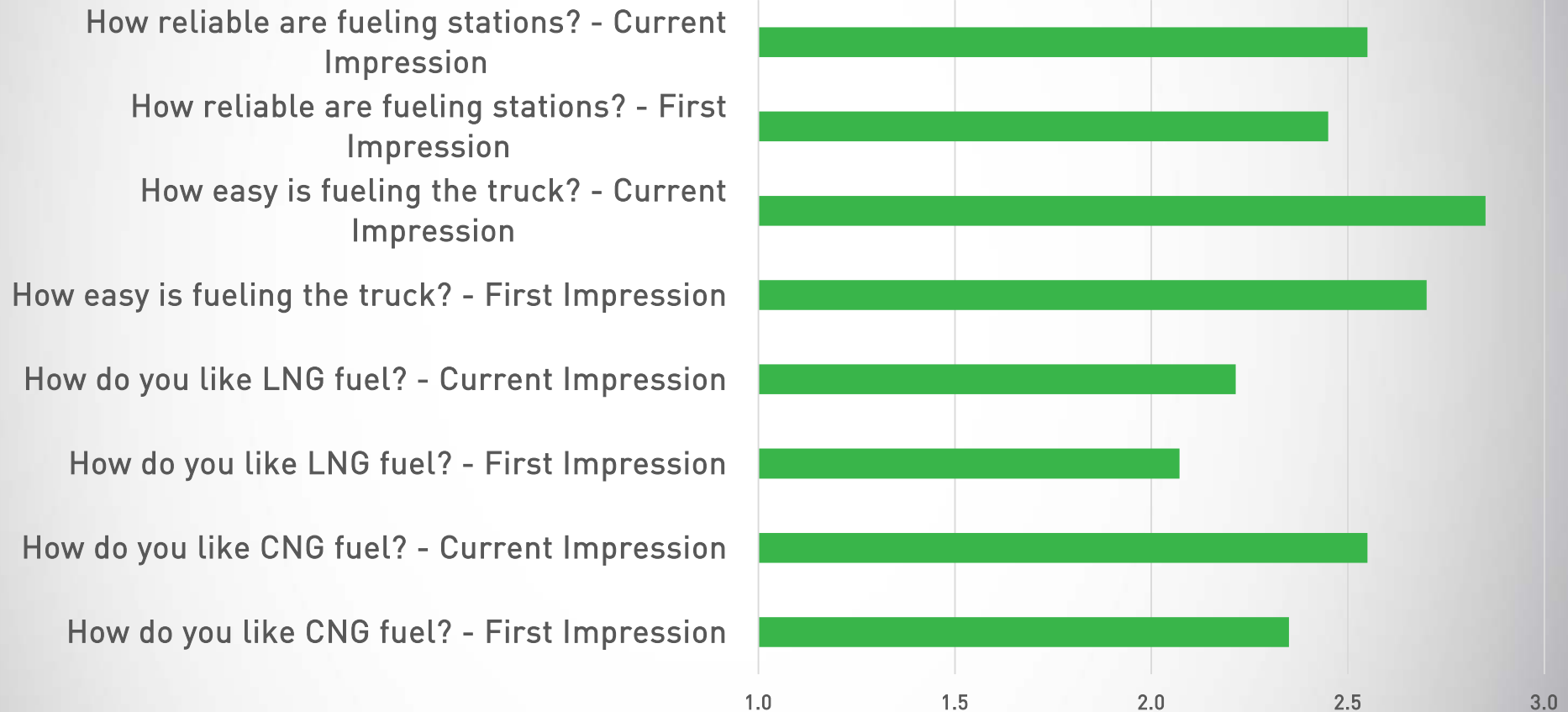

Average of 21 Responses

Survey Scale:

3 – Highest Rating

2 – Middle Rating

1 – Lowest Rating

Only one rating of “1” under current impressions.



Operating Data

Cumulative Program Miles Traveled

■ TTSI ■ Pac9 ■ CR&R ■ 4 Gen ■ Orange Avenue ■ NFI

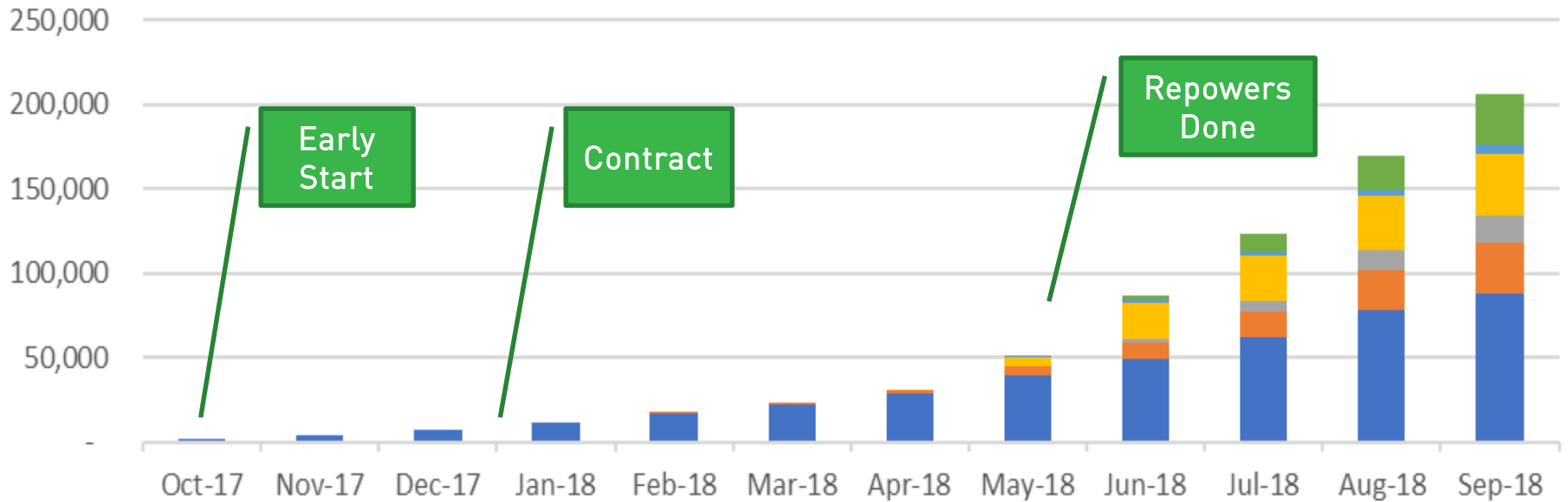

Operating Data

| Operating Results | Total Miles Traveled | Total Fuel Used (DGE) | Average Idle Time % | Fuel Economy (MPDGE) | N0x Reduced (US Pounds) | GHG Reduced (US Tons) |
|-------------------|----------------------|-----------------------|---------------------|----------------------|-------------------------|-----------------------|
| TTSI | 87,897 | 24,601 | 28% | 3.6 | 34.9 | 42.4 |
| Pac9 | 30,380 | 6,606 | 31% | 4.6 | 12.1 | 11.4 |
| CR&R | 15,567 | 2,800 | 29% | 5.6 | 6.2 | 4.8 |
| 4 Gen | 36,801 | 6,744 | 24% | 5.5 | 14.6 | 11.6 |
| Orange Avenue | 5,321 | 1,644 | 36% | 3.2 | 2.1 | 2.8 |
| NFI | 30,524 | 5,810 | 33% | 5.3 | 12.1 | 10.0 |
| Totals | 206,489 | 48,205 | 30% | 4.3 | 81.9 | 83.1 |

Demonstration Customer Idle % Summary

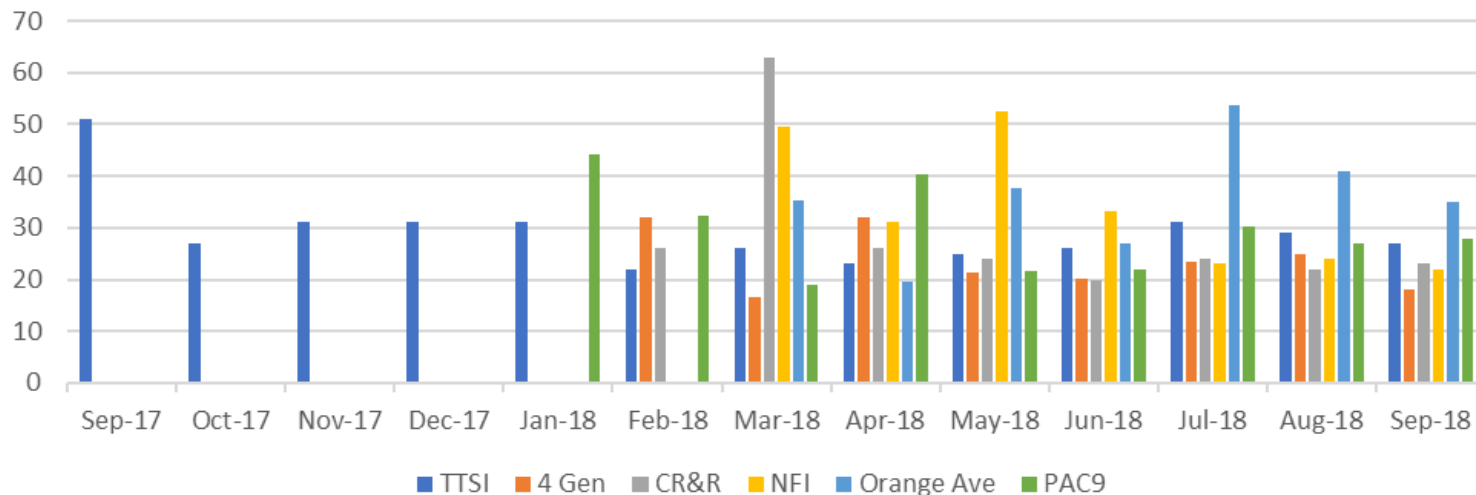

Preview of the Future!



Appendix 9

CWI Technical Product Update for ISX12N



South Coast Air Quality Management District
Southern California Trucking Demonstration of Near-Zero ISX12-G Engines
Final Report - Contract No. 18122 - Clean Fuels/CEC





Product Update

Cummins Natural Gas Engines

- EPA/CARB Ultra Low emissions certification
- Lowest Emission MR and HD engines in North America
- On-Board Diagnostics (OBD) applied for optimal emissions system performance
- Based on Cummins heavy duty diesel engine hardware set for extended service life



ISX12N™



L9N™



B6.7N™



ISX12N™

- Ultra Low Emissions: 0.02 g/bhp-hr NZ NOx emissions level
- 2019 HD OBD for optimal emissions performance
- Improved engine reliability & durability with new fuel system



Engine Changes

New fuel system

On-engine electric CCV filter with 2 CCP sensors

CM2380 ECM

500 kbaud datalink

New wiring harness

New ICM (common with 2018 ISL G)

Aftertreatment Changes

One-piece TWC

Mid-bed O2 sensor

OEM harnessing

Size increase for 0.02 NOx

ISX12N

- **Key Product Attributes:**

- Displacement – 11.9 Liters (762.2 CU IN)
- Peak rating 400 hp / 1,450 lb-ft torque
- Recommended use up to 80,000 lb. GVW
- **Certified** to CARB optional 0.02g Near Zero NOx Standard
- Maintenance and fluid free Exhaust treatment system
- The 12L platform has been in service since 2013
- Utilizes Cummins diesel engine block and major part hardware set designed for extended service life



MY 2018 ISX12N change overview

Emissions/Certification

0.02 g/bhp-hr NOx emissions level

Unibody TWC for 2018

2018 HD OBD Compliant

Power Cylinder

Anti-Polish Ring Similar to the X15

Crankcase Ventilation

Closed, on-engine, electric driven

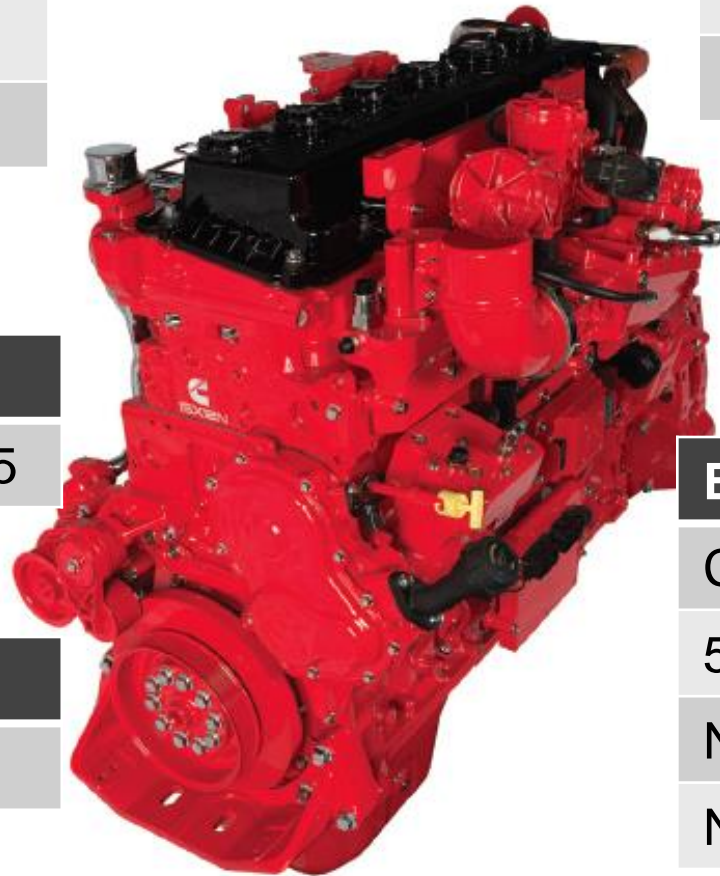

Fuel System

E-controls system

Compressor Recirculation Valve

Revised fuel supply connection

ECM/Harnessing

CM2380 ECM

500 kbaud datalink

New wiring harness

New ICM (common with 2018 ISL G)

MY 2018 ISX12N Fuel system/EGR

- Revised fuel module and EGR plumbing
 - Space claim impact
 - Maximum fuel inlet pressure will be reduced from 150 psi to ~100 psi
 - Throttle Intake Screen

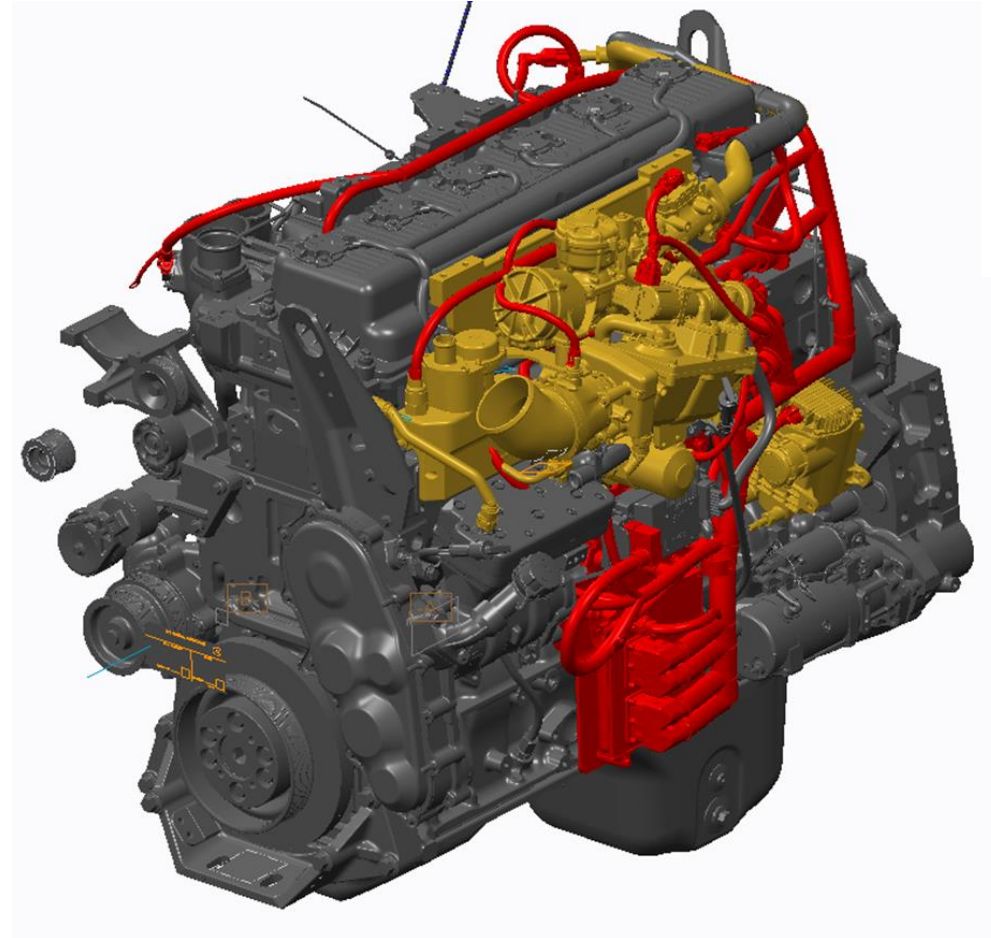

MY 2018 ISX12N Fuel system/EGR

- Compressor recirculation valve (CRV)
 - Front of engine space claim impact
 - Mechanical device which recirculates compressed air to compressor inlet based on threshold of Throttle Inlet Pressure-Manifold Absolute Pressure
 - Improves turbo compressor durability
 - Enables quieter operation

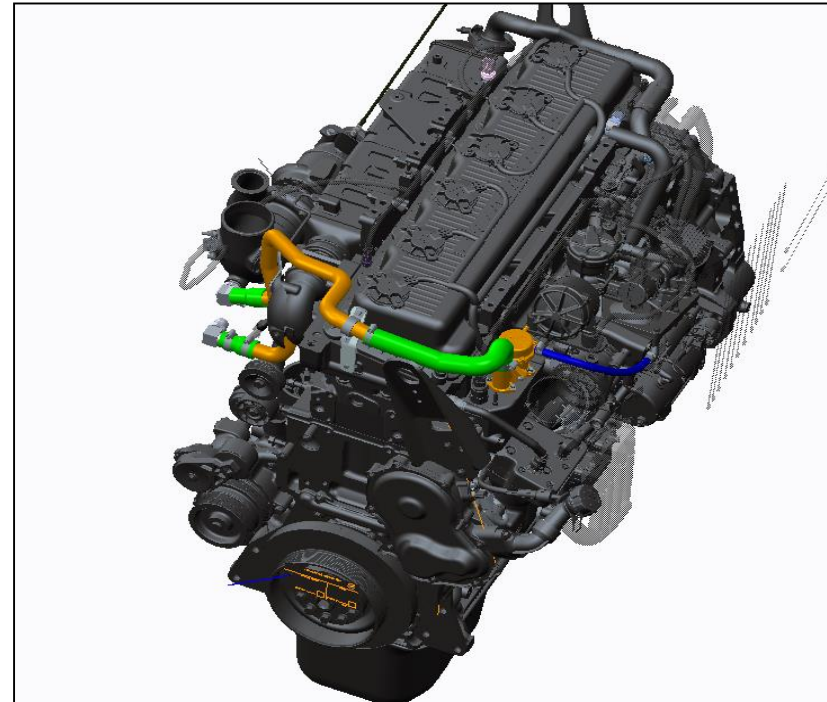

MY 2018 ISX12N Fuel Connection/Filtration

- Fuel connection strategy will be different than current product
 - On-engine CCV occupies location where on-engine connection point is on current product
 - Planned connection point above ICM
 - Current product off-engine filter will not be required if high pressure filter meets requirements
- Maximum fuel inlet pressure will be reduced from 150 psi to ~100 psi

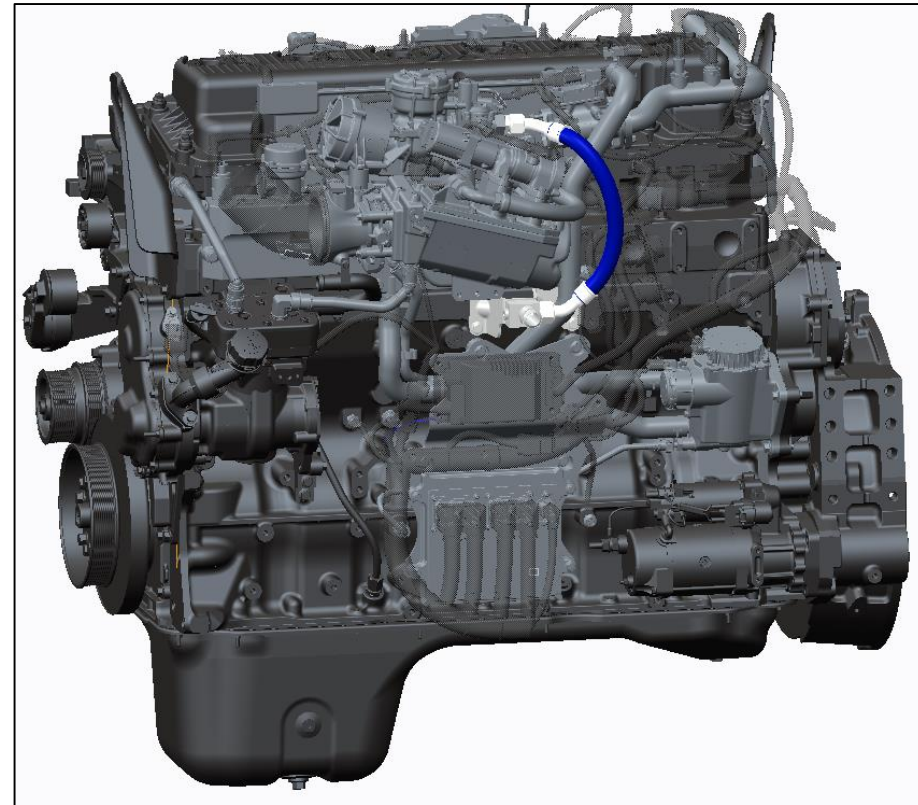

MY 2018 ISX12N Closed Crankcase Ventilation (CCV)

- On-engine filter
 - Electric driven centrifugal filter

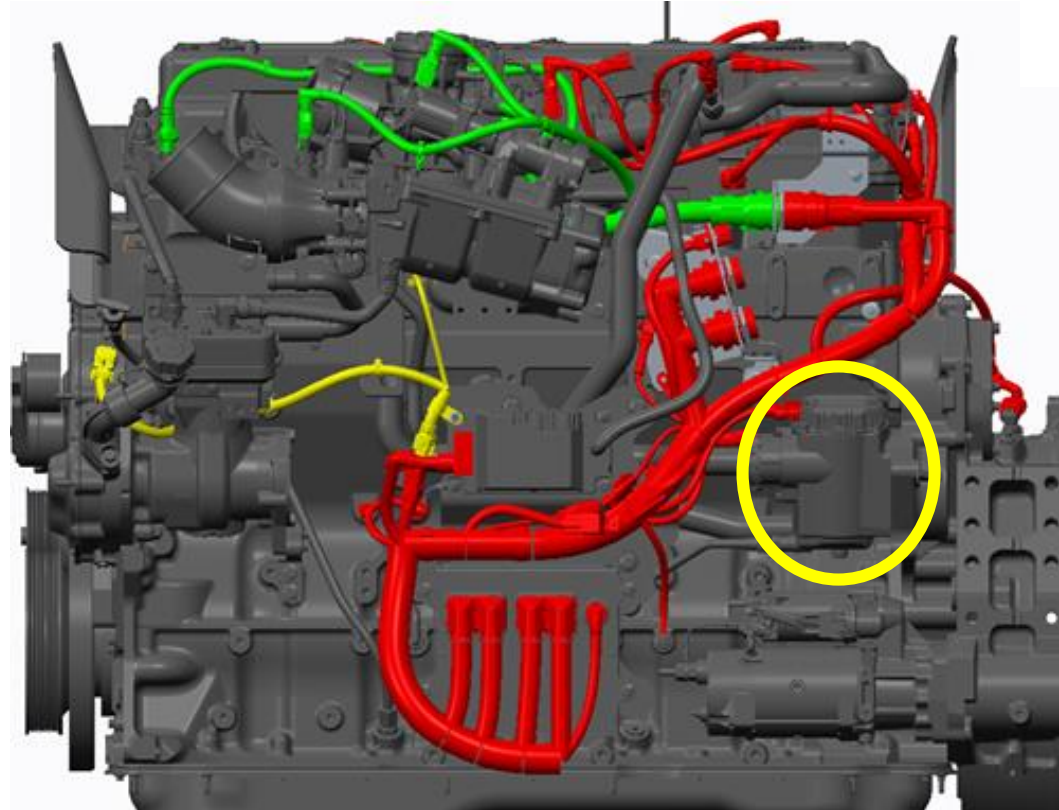

MY 2018 ISX12N Engine and Ignition harness

- Redesigned harness to accommodate updated fuel and CCV systems
 - New harness was designed with no metal P-clips.

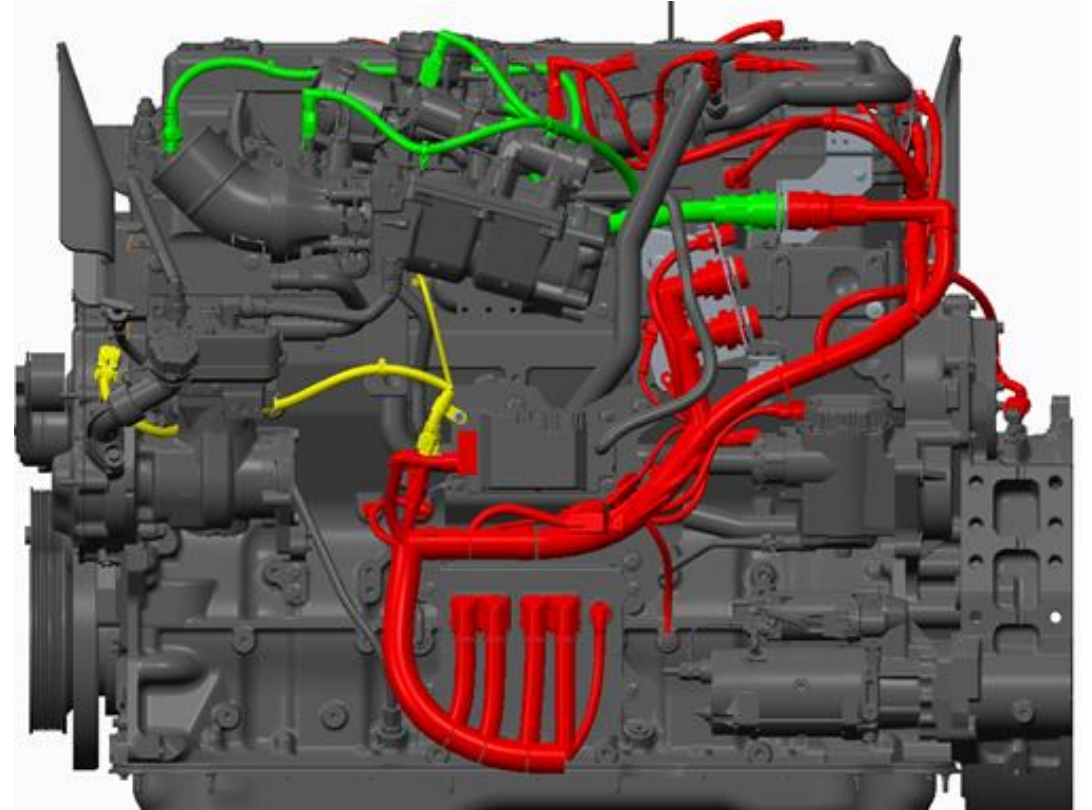



Appendix 10

Project Cost Details



Near-Zero Demonstration Project
Project Participant Co-Funding Summary

| | | |
|----------------------|----------------------------------|-----------------|
| Clean Energy | Truck Acquisition | \$ 64,260.00 |
| Clean Energy | Truck Repairs | \$ 34,960.05 |
| Clean Energy | Truck Registration & Taxes | \$ 57,277.00 |
| Clean Energy | Labor | \$ 271,050.00 |
| Clean Energy | Subtotal | \$ 427,547.05 |
| Participating Fleets | Operating, Maintenance & Repairs | \$ 2,289,459.59 |
| Co-Funding Total | | \$ 2,717,006.64 |

Near-Zero Demo Project
Unreimbursed Truck Costs Incurred by Clean Energy

2 Cost Categories:

| | |
|---|------------------|
| Truck Operating Expenses - DMV Registration & Federal Highway Tax | 57,277.00 |
| Truck Repair Expenses | 34,960.05 |
| Total Expenses | 92,237.05 |

| Truck Operating Expenses - DMV Registration & Federal Highway Tax | Customer | Qty | Amount | Total |
|--|--|------------|---------------|------------------|
| 2018 DMV Registration - SK Enterprises Filing Fee | NA | 1.00 | 3,550.00 | 3,550.00 |
| 2018 Federal Heavy Highway Vehicle Use Tax | Premium Transportation Services (TTSI) | 4.00 | 550.00 | 2,200.00 |
| 2018 Federal Heavy Highway Vehicle Use Tax | Pacific 9 Transportation, Inc. | 4.00 | 550.00 | 2,200.00 |
| 2018 Federal Heavy Highway Vehicle Use Tax | 4 Gen Logistics, LLC | 3.00 | 550.00 | 1,650.00 |
| 2018 Federal Heavy Highway Vehicle Use Tax | CR&R | 1.00 | 550.00 | 550.00 |
| 2018 Federal Heavy Highway Vehicle Use Tax | Orange Avenue Express | 3.00 | 550.00 | 1,650.00 |
| 2018 Federal Heavy Highway Vehicle Use Tax | NFI Interactive Logistics, LLC | 4.00 | 550.00 | 2,200.00 |
| 2018 Federal Heavy Highway Vehicle Use Tax | Green Fleet Systems, LLC | 1.00 | 550.00 | 550.00 |
| 2019 DMV Registration | Premium Transportation Services (TTSI) | 1.00 | 2,470.00 | 2,470.00 |
| 2019 DMV Registration | Pacific 9 Transportation, Inc. | 4.00 | 2,470.00 | 9,880.00 |
| 2019 DMV Registration | 4 Gen Logistics, LLC | 3.00 | 2,470.00 | 7,410.00 |
| 2019 DMV Registration | CR&R | 1.00 | 2,470.00 | 2,470.00 |
| 2019 DMV Registration | Orange Avenue Express | 3.00 | 2,470.00 | 7,410.00 |
| 2019 DMV Registration | NFI Interactive Logistics, LLC | 4.00 | 2,470.00 | 9,880.00 |
| 2019 DMV Registration | Green Fleet Systems, LLC | 1.00 | 2,470.00 | 2,470.00 |
| 2019 DMV Registration Service Charges | NA | 1.00 | 737.00 | 737.00 |
| Total Operating Expenses | | | | 57,277.00 |

| Truck Repair Expenses | Customer | Qty | Amount | Total |
|---|--------------------------------|------------|---------------|------------------|
| Replace Batteries, Rush | Pacific 9 Transportation, Inc. | 4.00 | 591.69 | 2,366.76 |
| Towing to Reposition Trucks | Pacific 9 Transportation, Inc. | 4.00 | 330.00 | 1,320.00 |
| Replace Batteries, Disconnect LNG Warning Lights | 4 Gen Logistics, LLC | 1.00 | 1,820.89 | 1,820.89 |
| Replace Batteries, Secure Catwalk | 4 Gen Logistics, LLC | 1.00 | 919.34 | 919.34 |
| Replace Batteries, Disconnect LNG Warning Lights | 4 Gen Logistics, LLC | 1.00 | 1,623.02 | 1,623.02 |
| Replace Batteries | 4 Gen Logistics, LLC | 1.00 | 833.06 | 833.06 |
| Towing to Reposition Trucks | 4 Gen Logistics, LLC | 4.00 | 300.00 | 1,200.00 |
| Installed new air horn and routed the air lines, linkage-low air leaf kit, speedometer test | Orange Avenue Express | 1.00 | 2,501.62 | 2,501.62 |
| Replace batteries & disconnect LNG warning lights | Orange Avenue Express | 1.00 | 833.06 | 833.06 |
| Replace air spring bag & 2 front shocks | Orange Avenue Express | 1.00 | 319.49 | 319.49 |
| Replace driver's mirror, checked horn, installed new headlamp bulbs, battery performance test, replace hood cable | Orange Avenue Express | 1.00 | 5,317.38 | 5,317.38 |
| Replace batteries and disconnect LNG warning lights | Orange Avenue Express | 1.00 | 1,067.85 | 1,067.85 |
| Install air horn assembly, installed wiper arm assembly & both blades, replaced air fitting on air tank | Orange Avenue Express | 1.00 | 2,242.93 | 2,242.93 |
| Replace batteries and disconnect LNG warning lights | Orange Avenue Express | 1.00 | 1,049.78 | 1,049.78 |
| Replaced batteries and disconnect LNG warning lights | CR&R | 1.00 | 847.64 | 847.64 |
| Replace batteries, disconnect LNG warning lights | Green Fleet Systems, LLC | 1.00 | 1,181.15 | 1,181.15 |
| Electrical repair | Green Fleet Systems, LLC | 1.00 | 1,170.44 | 1,170.44 |
| Replaced leaking 90 and leaking air bag, advise on check engine warning light | NFI Interactive Logistics, LLC | 1.00 | 1,513.61 | 1,513.61 |
| Statewide Tow bill + replace batteries and disconnect LNG warning lights | NFI Interactive Logistics, LLC | 1.00 | 2,362.28 | 2,362.28 |
| Replace batteries, disconnect LNG warning lights, cut key | NFI Interactive Logistics, LLC | 1.00 | 1,070.19 | 1,070.19 |
| Replaced batteries and disconnect LNG warning lights | NFI Interactive Logistics, LLC | 2.00 | 1,049.78 | 2,099.56 |
| Towing to Reposition Trucks | NFI Interactive Logistics, LLC | 4.00 | 325.00 | 1,300.00 |
| Total Repair Expenses | | | | 34,960.05 |

**Near-Zero Demo Project
Clean Energy Staff Labor**

| Staff Member | Total Hours |
|-------------------|-------------|
| Greg Roche | 1,232 |
| Doe Girling | 99 |
| Amy Flahive | 32 |
| Allison Geane | 173 |
| Justin Sarkis | 70 |
| Domenique Follico | 57 |
| Nadia Ramirez | 62 |
| Marcos Luna | 24 |
| JJ Armstrong | 58 |
| | |
| Total Hours | 1,807 |
| Hourly Rate | \$ 150 |
| Labor Total Cost | \$ 271,050 |

Appendix 11

Media





Press Room



MAY 8, 2018

Trucking Firms Deploy Ultra Clean Near-Zero RNG Trucks At Ports Of Long Beach And Los Angeles

NEWPORT BEACH, Calif. – Six trucking firms operating in the Ports of Los Angeles and Long Beach are deploying trucks powered by Cummins Westport (CWI) near-zero ISX12N engines, and fueled with [Clean Energy Fuel Corp.'s](#) (Nasdaq: [CLNE](#)) [Redeem™](#) brand renewable natural gas (RNG) in an effort to reduce emissions and improve air quality in the ports and surrounding communities.

The project's goal is to introduce this ultra clean technology, which is 90 percent to 99 percent cleaner than existing port trucks, to the port drayage industry. This project aims to inspire greater interest in [near-zero RNG trucks](#), particularly with the incentive funding that California is providing to help truckers transition to this clean technology. Near-zero trucks are also one of the strategies for reducing emissions from trucks under the ports' recent update to their Clean Air Action Plan (CAAP).

"The realization by trucking companies that they need to do something to meet the upcoming and anticipated stricter emissions requirements in California is beginning to settle in," said Greg Roche, Clean Energy's vice president of sustainable trucking. "Fortunately, there are many ways to take advantage of [grants](#) and other resources to make the transition to the new engine technology and clean RNG virtually painless. We applaud these first-movers in being leaders in doing their part to make the air we all breathe cleaner."

The California Energy Commission and the South Coast Air Quality Management District provided funding for 20 near-zero [Class 8 trucks](#). The Ports of Los Angeles and Long Beach provided funding for two additional near-zero trucks. The first four near-zero trucks have been successfully operating since mid-2017 and an additional four have been operating since February 2018.

"The California Energy Commission is pleased to have supported the deployment of near-zero emissions trucks powered by Cummins Westport's advanced engines with our partners, the South Coast Air Quality Management District and Clean Energy," said Energy Commissioner Janea A. Scott. "Demonstration projects, like those being carried out by the Ports of Los Angeles and Long Beach, help show there are viable cleaner, more sustainable freight technologies available today and highlight the role these technologies can play as the State transitions to zero and near zero emission technologies to help achieve federal air quality standards and the state's greenhouse gas goals."

SHARE



Keep up-to-date with the latest in Clean Energy natural gas fueling news

[SUBSCRIBE TODAY](#)

MEDIA RESOURCES

[Press Room](#)

[Sustainability](#)

[Release Archive](#)

[Digital Press Kits](#)

[Video](#)

[Download Library](#)

[Executive Bios](#)

[Blog](#)

Near-Zero-Emissions Heavy Duty Trucks Now Hauling Freight At Southern California Ports

August 20th, 2018 by **Steve Hanley**



Almost a half-trillion dollars' worth of goods are imported in the US through the ports of Los Angeles and Long Beach every year. Almost all the containers that arrive at those ports are hauled relatively short distances to freight distribution facilities located inland by special purpose drayage trucks designed specifically for such short-haul work. At those freight terminals, the containers are hooked up to the long-distance tractors that will deliver them to every part of America.

With so much cargo coming in, tens of thousands of trips between the ports and the terminals take place all day every day. With rare exceptions, all those drayage trucks are equipped with diesel engines that spew out tremendous quantities of carbon dioxide, nitrogen oxides, and sulfur oxide emissions, making the air in the vicinity more polluted than in any other area of the country.

To reduce that air pollution, the ports of Los Angeles and Long Beach formed the Clean Air Action Plan in 2006. It was a comprehensive program designed to curb emissions from ships, tugboats, cargo cranes, and drayage trucks, almost all of which are powered by diesel engines.

In 2008, the ports unveiled the Clean Trucks Program which began by banning all trucks from the ports that were manufactured prior to 1989. Since then, the program has been upgraded several times. In 2012, it brought the ban on older trucks forward to exclude any vehicles manufactured before 2007.

On October 1, the plan will be updated once again to exclude any trucks made before 2014. The goal is to make all transportation within the South Coast Air Quality Management District, which includes both ports, zero emissions by 2035. Since its beginning, the CAAP has reduced the amount of particulates emitted by 85%, nitrogen oxides by 50%, and sulfur oxides by 95% according to Advanced Clean Transportation News.

Recently, 6 freight hauling companies have started using 22 new drayage trucks equipped with near-zero-emissions diesel engines manufactured by Cummins Westport. The ISX12N engines run on renewable natural gas. The combination of clean burning engines and low-carbon fuel results in the lowest diesel emissions in America. Emissions from these engines are 90% lower than the current diesel emissions standards mandated by the California Air Resources Board and the EPA (what's left of it.) The engines are being installed in trucks manufactured by Peterbilt, Freightliner, and Kenworth.

Renewable natural gas is “an ultra-clean and ultra-low-carbon natural gas alternative made from the methane that is captured when waste from food scraps, animal manure, sewage and other organic sources is broken down, captured and refined. RNG has the lowest carbon intensity rating of key transportation fuels when comparing the well-to-wheels greenhouse gas (GHGs) emissions of various fuels in heavy-duty trucking applications,” says ACT News.

Vic LaRosa, President of Total Transportation Services, says, “TTSI has now been testing the new CWI natural gas engines since last year and have found that they work terrifically. We have run the trucks hard — in and out of the ports for long hours in all kinds of conditions — and have had no issues. TTSI is committed to going above and beyond what we can towards a more sustainable future and transitioning to renewable natural gas has made it easy.”

Someday, electric trucks from Tesla and other manufacturers will end the scourge of emissions from heavy duty diesel engines. Until then, near-zero-emissions diesel engines are an important step forward on the road to a pollution-free future.

About the Author



Steve Hanley Steve writes about the interface between technology and sustainability from his home in Rhode Island and anywhere else the Singularity may lead him. His motto is, "Life is not measured by how many breaths we take but by the number of moments that take our breath away!"

Retrieved From:

<https://cleantechnica.com/2018/08/20/near-zero-emissions-heavy-duty-trucks-now-hauling-freight-at-southern-california-ports/> on 10/16/2019

Near-Zero Emission Trucks Deployed in Busiest Port Complex

by **Todd Campbell**

August 16, 2018

The air is getting cleaner in the Ports of Long Beach and Los Angeles, thanks to the efforts of six progressive harbor trucking firms that are demonstrating we can slash transportation emissions immediately and cost effectively with today's near-zero emission natural gas trucks. The trucking companies have deployed 22 Class 8 drayage trucks—equipped with the Cummins Westport (CWI) near-zero ISX12N engine and fueled with Clean Energy Fuels Redeem brand renewable natural gas (RNG)—which achieve the lowest emissions of any heavy-duty truck operating in North America. They were deployed as part of a pilot program, with funding assistance from the California Energy Commission, the South Coast Air Quality Management District, and the two ports

Commercially Available Technology

The CWI 2018 ISX12N engine is certified to the California Air Resources Board (ARB) and Environmental Protection Agency (EPA) Optional Low NOx emissions standard of 0.02 g/bhp-hr — 90 percent lower than current emissions standards. Along with CWI's L9N and B6.7N, these engines continue the evolution of clean technology from CWI, offering ultra-low emission engines that can run on CNG, RNG or LNG. The engines are already being factory installed by reputable truck manufacturers with established sales and service networks, including Freightliner, Kenworth and Peterbilt.

Ultra-Clean Renewable Fuel

RNG is an ultra-clean and ultra-low-carbon natural gas alternative made from the methane that is captured when waste from food scraps, animal manure, sewage and other organic sources is broken down, captured and refined. RNG has the lowest carbon intensity rating of key transportation fuels when comparing the well-to-wheels greenhouse gas (GHGs) emissions of various fuels in heavy-duty trucking applications. Based on the California Air Resources Board's carbon intensities, RNG can reduce GHG emissions by 40 to 125 percent or more, depending on the renewable feedstock used to produce it. In California, nearly all of the natural gas used for transportation fuel is produced from renewable feedstocks, which has enabled RNG producers to mitigate fugitive methane emissions and drive job creation.

An Immediate Solution to Achieve Clean Air Where It's Needed Most

Combined, the Ports of Long Beach and Los Angeles are the nation's largest goods movement hub, moving \$450 billion dollars of cargo each year through Southern California to cities across the nation. While the ports are a major source of economic development in the region, they are also the leading source of harmful smog emissions—largely due to the tens of thousands of trucks driving to and from this complex each day. The 22 near-zero emission natural gas trucks—deployed by Total Transportation Services, Inc. (TTSI), 4Gen Logistics, Orange Avenue Express, CR&R, and Pacific 9 Transportation—are part of the ongoing landmark efforts by the ports to reduce goods movement emissions for the region. Back in 2006, the Ports of Long Beach and Los Angeles adopted the Clean Air Action Plan (CAAP), becoming the first seaport complex

in the world to enact such a progressive and comprehensive program to reduce emissions from maritime goods-movement-related mobile sources – ships, trucks, trains, harbor craft (such as tugs and workboats), and cargo-handling equipment (such as cranes and yard tractors). In 2008, the ground-breaking Clean Trucks Program was launched, which initially banned pre-1989 trucks, and later followed by a progressive ban on all trucks that did not meet 2007 emission standards by 2012. Since the launch of the CAAP, these strategies have resulted in emission reductions exceeding 85% for particulate matter, 50% for nitrogen oxides, and 95% for sulfur oxides.

Updates were made to the CAAP in 2010 and 2017, with the Harbor Commissioners for both ports approving the 2017 updates earlier this summer. The 2017 update to the CAAP will begin the push for even cleaner standards for trucks and seek to phase out older trucks (effective Oct. 1, 2018, any trucks registering in the required Ports Drayage Truck Registry for the first time will be required to be a 2014 model year or newer), with a goal of transitioning to zero emission trucks by 2035.

The good news is that Southern California residents living in areas impacted by pollution from commercial vehicles don't have to wait nearly two decades for clean air—and not surprisingly, they don't want to. A survey reported by the Coalition for Clean Air (CCA) found impacted residents are in favor of immediately deploying today's commercially available near-zero heavy-duty trucks to combat harmful emissions and will look to a zero-emission solution once it's ready to deploy on a larger scale. Additionally, an overwhelming 90 percent of voters have no clear preference between near-zero trucks fueled by renewable natural gas (RNG) fuel, or trucks powered by zero-emissions electric vehicles.

The 22 near-zero RNG fueled drayage trucks successfully operating in the ports are supporting the CAAP goals and introducing a commercially available ultra-clean technology to the port drayage industry. "TTSI has now been testing the new CWI natural gas engines since last year and have found that they work terrifically," said Vic LaRosa, President of TTSI, in May 2018. "We have run the trucks hard – in and out of the ports for long hours in all kinds of conditions – and have had no issues. TTSI is committed to going above and beyond what we can towards a more sustainable future and transitioning to renewable natural gas has made it easy."

The participating trucking firms are leading by example and are already inspiring many other fleets in the region to follow suite. Nearly 500 applications were submitted to the South Coast Air Quality Management district to fund near-zero emission trucks across all applications, many of which were port drayage trucks. Stay tuned for exciting announcements later this fall of which companies will be awarded funding to deploy even more near-zero emission trucks starting in early 2019.

Retrieved From: <https://www.act-news.com/news/deploying-near-zero-emission-trucks/> on 10/16/19

Cummins Westport Tests Ultra-Low Emissions Natural Gas Engines

October 05, 2017 by Clarissa Hawes



Container shipping specialist Heavy Load Transfer moves cargo up the Vincent Thomas Bridge at the Port of Long Beach with the new CWI ISX12N Ultra-Low NOx Natural Gas Engine. (Photo: California Natural Gas Vehicle Coalition)

Cummins Westport and the California Natural Gas Vehicle Coalition have begun testing new low emissions natural gas engines in drayage trucks at the Southern California port complex.

The joint venture between Cummins Inc. and Westport Innovations is testing 20 trucks equipped with the 12-liter ultra-low emissions natural gas engine – called the ISX12N – across seven drayage fleets in the San Pedro Bay in Los Angeles. The engines produce 400 horsepower and 1,450 pound-feet of torque.

Cummins will add another 16 trucks with the new engines at the ports of Los Angeles and Long Beach within the next 30 days, said Hugh Donnell, head of the company's North America truck segment.

The company also is testing another 10 trucks in fleets in Wisconsin, Florida and Texas.

“We accumulate miles to validate and verify that our product is doing what we want it to do,” Donnell told Trucks.com. “It’s a testing process that goes on for generally a year or more.”

All of the major truck manufacturers except Navistar are participating in the testing.

The near-zero emissions technology can lower three key types of tailpipe pollutants: nitrates of oxygen or NOx, smog-causing diesel particulates and greenhouse gases, or GHG. The engine produces 0.02 grams of NOx per horsepower-hour, which is 90 percent less than the current Environmental Protection Agency standard of 0.2 grams.

Environmental groups like the California Air Resources Board and air quality officials believe trucks equipped with such engines will help eliminate harmful diesel emissions from trucks operating out of the ports of Long Beach and Los Angeles, the nation's largest port complex.

Cummins recently filed to receive CARB certification and hopes for approval from the agency in November, Rob Neitzke, president of Cummins Westport, told Trucks.com.

"We understand the importance of reducing NOx emissions, especially here in California and in one of the busiest transportation corridors in the nation," said Neitzke.

On Nov. 2, the ports of Los Angeles and Long Beach will consider changes to its Clean Air Action Plan, or CAAP, to replace diesel trucks with cleaner technologies such as the ISX12N engine. The mayors of Los Angeles and Long Beach have set a goal to have near-zero or zero emissions at the complex by 2035.

The California Natural Gas Vehicle Coalition, or CNGVC, recently introduced its own plan – the Advanced Clean Trucks Now plan, or ACT Now – which calls on the ports to replace diesel trucks with near-zero and zero emission trucks over the next five years to improve regional air quality and reduce GHG.

"The time to act is now" because the California legislature recently passed its Clean Air Initiative, providing \$895 million in grant money for reducing emissions from mobile sources, including heavy-duty trucks, said Greg Roche, vice president of sustainable trucking for Clean Energy Fuels.

"This is the most money that's ever been available in this state to clean up diesel trucks," Roche told Trucks.com. "For the ports, this is an opportune time to make a change because money is available to help them do this. There's no guarantee that this money will be available in the future."

By using renewable natural gas, or RNG, the new engine reduces GHG emissions by 70 percent or more, Roche said.

"This is a major step on how the air quality can be improved immediately," Roche said, while the industry works on other technologies such as electric trucks and hydrogen fuel cell vehicles, both of which are also undergoing testing.

As part of the testing, the CNGVC, which comprises Cummins Westport, Clean Energy and more than 20 other companies, including UPS and Freightliner Trucks, released a video featuring Victor LaRosa Jr., a truck driver for Heavy Load Transfer, driving the vehicle over the steep bridges at the Southern California port complex and through the mountainous section of Interstate 5 known as the Grapevine.

"It performed great, especially on the higher grade on the Grapevine," LaRosa Jr. told Trucks.com.

Retrieved From: <https://www.trucks.com/2017/10/05/cummins-westport-low-emissions-natural-gas-engines/> on 10/16/19

New Clean Engine Technology Servicing The Ports Of Los Angeles Or Long Beach

Published by TTSI on 9/05/2019



Total Transportation Services (TTSI), one of the nation’s leading port drayage companies, has taken delivery of 20 Volvo and 20 Freightliner Class 8 trucks all equipped with the new Cummins ISX12N Natural Gas engines.

This is the largest single purchase to date of this new clean engine technology of any fleet servicing the Ports of Los Angeles or Long Beach. The acquisition, part of TTSI’s commitment to convert 100% of its fleet to a near-zero and zero-emission platform by 2020, confirms that the platform is viable, durable and cost-effective in the Port environment.

“The new Cummins engine is ideally suited for use in the Port drayage application,” said Vic LaRosa, President of TTSI and recent awardee of the Coalition for Clean Air’s annual visionary award. “This purchase also confirms TTSI’s commitment to taking a leadership position in the maritime industry and will hopefully help the Ports meet their zero-emission goals spelled out in the recent update to the San Pedro Bay Clean Air Action Plan.”



Cummins ISX12N Natural Gas engines

TTSI has previously adopted alternative fuels trucks into its fleet, including all-electric battery, hydrogen fuel-cell, and hybrid technologies. Integration of the new Cummins engine on this large a scale, however, signals TTSI's confidence of the latest technology and the long term viability of natural gas as a near-zero-emission solution.

“We are pleased to have partnered with TTSI on this order,” said Tom Swenson, Manager for Cummins Natural Gas Group. “TTSI has once again demonstrated that remaining competitive in the Port drayage market and deploying near-zero and zero-emission technologies are not mutually exclusive.”

TTSI remain among the top carriers not only in the Southern California market but also in the East Coast (Virginia) and Pacific Northwest (Seattle/Tacoma) markets where it has a significant presence.

“With this delivery, TTSI has demonstrated its willingness to get ahead of the curve on environmental and operational issues,” said Noel Hacegaba, Deputy Executive Director of the Port of Long Beach.

The 40 trucks will be immediately deployed into drayage service for TTSI hauling for large BCO customers such as Target, Amazon, and others.

Retrieved From: <https://ttsi.com/new-clean-engine-technology-servicing-the-ports-of-los-angeles-or-long-beach/> on 10/16/19

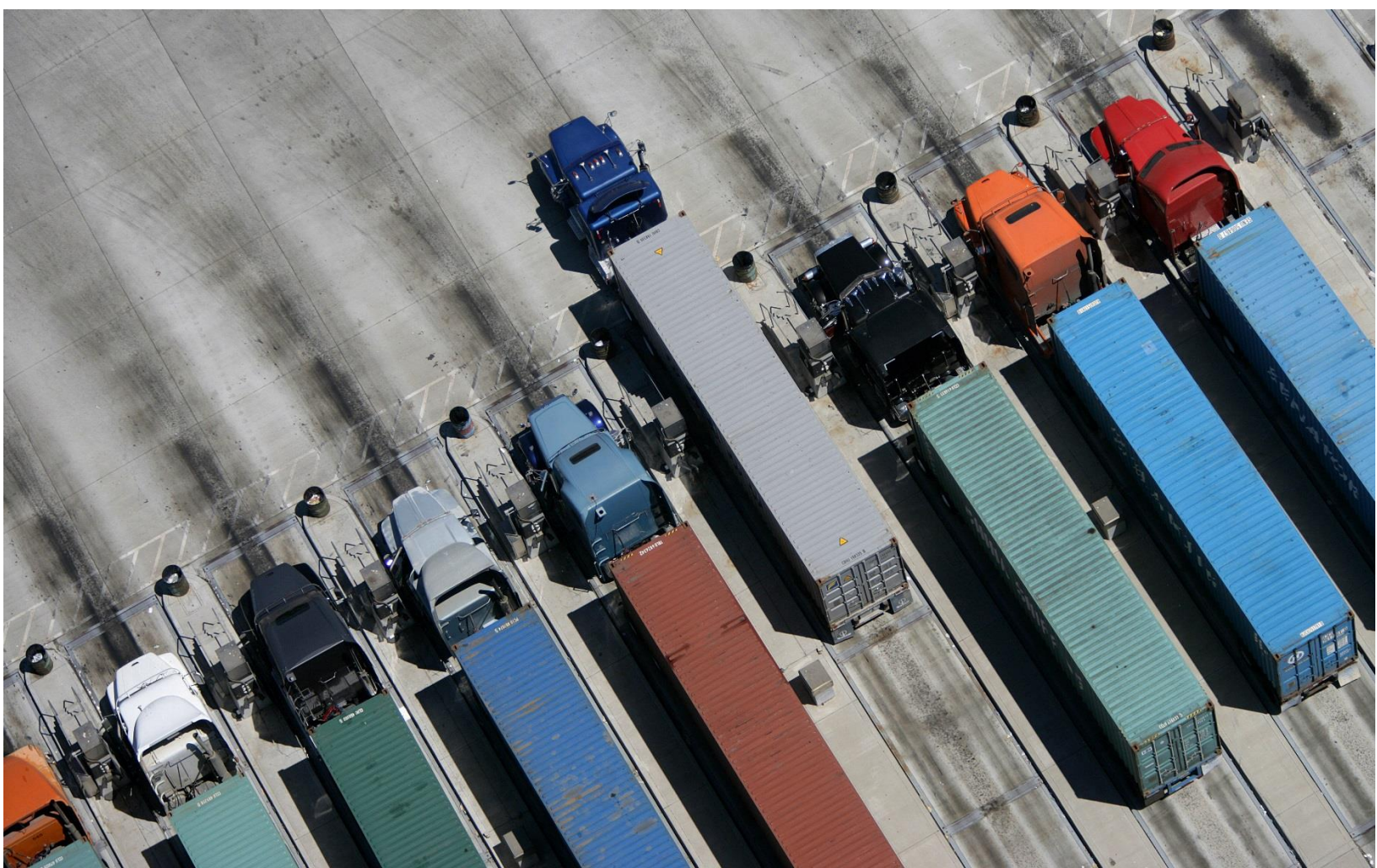

SAN PEDRO BAY PORTS
CLEAN AIR ACTION PLAN

2018 FEASIBILITY ASSESSMENT
for DRAYAGE TRUCKS

MARCH 2019

UPDATED WITH ADDENDUM MARCH 2020